

DIGITAL PROPORTIONAL SYSTEM

# XG8

**8 Channel 2.4GHz DSM5**

**dual modulation spectrum system**

## Operation Manual

Prior to use, please read this manual thoroughly.

Keep this manual in a convenient place for quick and easy reference.



**JR PROPO<sup>®</sup>**

# Greetings

## Thank you for choosing to purchase this JR product.

This is a highly functional product with outstanding operability that concentrates the essence of the technology built up by this company through long experience. In order to make full use of these features and safely enjoy your RC activities, please carefully read this operation manual. Our whole company hopes that you will enjoy using this product for many years.

# Features

**This is a multi-functional 8-channel transmitter that is capable of supporting many aircraft models.  
It contains functions that are equivalent to those in more advanced level transmitters.**

- A newly developed DMSS system is incorporated that maintains a high-speed response while allowing use of a telemetry function.
- Using the high-speed telemetry function, information from the aircraft side that was previously unknown can be confirmed using the transmitter. In addition, alarms using sounds are also fully equipped so that the situation at the aircraft side can be understood without even looking at the screen.
- The telemetry sensor connection employs a bus system that does not require a relay box, which enables sensor extension and addition to be easily carried out. It is acceptable merely to connect the necessary sensors in parallel.
- A new-generation long-lifetime Li-Fe battery is incorporated that has contributed to a large reduction in the transmitter weight. Further, a charging control circuit is also built in to the transmitter.
- Using the automatic confirmation system, the receiver side will not operate and safety will be maintained in the situation where the model selection has been mistakenly set in the transmitter before flight.
- The product has an easily viewed backlit LCD display and input keys that have outstanding operability.
- An E-ring function is provided that allows setting of the limitation of the operation range of the CCPM swash plate servos to be easily carried out.
- A Trim In function is provided that allocates the trim levers to the numerical value settings of the necessary functions.
- A function is incorporated that synchronizes the operation of each of the servos of multiple flight control surfaces in real time using mixing. This has completely eliminated the time lag when operations have been swiftly carried out.
- An SD card slot is incorporated that enables saving of aircraft model data and updating of software to be easily carried out without connecting the transmitter with a PC using a cable.
- An auto-display function is incorporated that allows the digital trim operation to be preferentially displayed on the screen.
- When inputting numerical values, simultaneously pressing the function key allows the values to be changed at a 10-times faster speed.
- Servo speed functions are incorporated in all channels, allowing adjustment to be carried out in each operation direction.
- The 30-aircraft model memory can be utilized for storing helicopter, airplane, and glider models.
- A Trainer function is incorporated, and the transmitter also has a function that allows training to be carried out for each Stick channel.
- The throttle, pitch curve, and curve mixing uses a multiple point adjusting method employing an exponential curve that enables smoother curve setting.
- Six systems of multi-functional program mixing are incorporated.
- A Touch Select function is incorporated which carries out automatic setting during switch selections such as Device Setting when you directly operate the switch that you wish to use. This allows setting to be easily carried out.
- A My List screen is provided that enables display and simple calling up only of the functions that the user has selected.
- Switch arrangement stickers are included for each transmitter model type so that users can change the switch arrangement stickers as they please for airplanes and helicopters which were previously separated.
- Stick units have been mounted externally at a tilted angle so that they can be easily operated in all head operating range areas. Slant mounting is employed.

# General Precautions for Safety

It is very important to ensure that you observe the following precautions.

## About the Proportional System

Please understand that this company cannot be responsible for any accident or failure that may occur from the modification of this product, use of non-genuine parts, natural disaster, or non-observance of the precautions described in this manual. Further, as for damages caused by an accident or failure, please understand that items (such as airplanes, competitors' products, fuel, etc.) excepting this product and this Company's genuine parts will not be covered under the warranty. The use of radio waves required in this product is defined as follows in the Radio Law of Japan.

- When this product is used overseas, authorization by the law of the country will be required.
- When this product is used overseas for a purpose other than as a model, it may be subject to the restrictions in accordance with the Export Trade Control Order. In such a case, an export permit under the Order is required.

## Basic Precautions for Safe Use of the 2.4GHz System

- The 2.4GHz band is not a frequency exclusively for use with RC airplanes. This frequency band is in common use with the ISM (industry, science, and medical care) band which is widely used for short-distance transmission such as microwave ovens, wireless LAN, digital cordless phones, audio games, cellphone Bluetooth, and VICS. Therefore, the steering response of the 2.4GHz system may be degraded in an urban area. Further, as it is also used for ham and local area radio communications for mobile identification, please pay attention to possible influences from these. In the event of any adverse radio wave interference on an existing wireless station, immediately stop emitting radio waves and take interference avoidance measures.
- At a race track/airport, minimize use of a device that can affect the transmitter/receiver and be sure to confirm the safety beforehand. Also, always follow instructions given by the facility staff.
- If an aircraft is allowed to fly behind a building, a pylon, trees, etc. so that the radio-wave range is blocked, the steering response may drop, even resulting in an "out-of-control" situation. Always let the aircraft fly within a range that can be visually observed.

## Indications and Symbols relating to Safety

The following symbols stated in this manual indicate the precautions regarding possible danger which may occur caused by improper handling.

Be sure to strictly observe them, as they contain important safety instructions.

**! DANGER**  
If incorrect operation methods are used, it is possible that there will be a danger of death or serious injury.

**! WARNING**  
If incorrect operation methods are used, it is possible that there will be a possibility of death or serious injury.

**! CAUTION**  
If incorrect operation methods are used, it can be expected that there will be a possibility of problems occurring.

 This indicates actions that are forbidden.  
Prohibited

 This indicates actions that must be implemented.  
Obligatory

## How to Handle

Before starting use, make sure that all the parts are provided. Then, connect the switch harness and servo to the receiver, and insert batteries into the transmitter/receiver. Turn on the transmitter/receiver and confirm that they operate correctly. If they do not operate, check the batteries. If a rechargeable battery is used for the first time after purchase or is used after being left unused for a long period, be sure to charge it with the battery charger before use.

In the event of any missing parts, malfunction, etc., please contact the Service Section of this Company.

**! WARNING**  
Out-of-control and dangerous situations can be caused.

DO NOT use the product on rainy days since it may cause malfunction if water gets inside the transmitter/receiver. If it should be used by necessity, make sure to take waterproof measures.

Injury due to heat generation, fire, or electric shock can occur.

Never disassemble or modify this product.

The engine and the motor (in the case of an electrically-driven model) can start rotating at high speed, causing danger.

When turning on the power switch, set the transmitter throttle stick to the lowest speed position (where the engine/motor rotation does not become high) and turn on the transmitter power switch and the receiver power switch in this order.

For turning off power, turn off the receiver and the transmitter in this order.

Injury can be caused.

When adjusting the engine (motor), fully pay attention to the power which comes from the rear side.

DO NOT start the engine with the transmitter throttle in a high speed position. This is very dangerous.

# General Precautions for Safety

It is very important to ensure that you observe the following precautions.

### WARNING

- ⊘ Failure can be caused.  
DO NOT use this module set in combination with a competitor's product (servo, gyroscope, etc.).
- ⊘ Malfunction can be caused.  
As the electronic parts mounted on the transmitter/receiver are susceptible to impact, DO NOT apply strong impact or drop them.
- ⚠ Out-of-control and dangerous situations can be caused.  
When degraded servo movement is detected, immediately stop operating and check the battery power remaining, servos, etc.
- ⊘ DO NOT use the product in the following places, as there is a risk of an out-of-control state or an accident occurring:
  - Transceiver interference exists.
  - Passing near to traffic consisting of cars and motorbikes.
  - Near a high-tension electric line, building, bank, or in a mountainous area etc.
  - Near an FM/TV station, or a radio transmitting station for ship radios.
  - Near residences and buildings, and near people.
- ⊘ A sudden malfunction may occur and will be dangerous.  
Even if the receiver, servo etc. goes under water and operates normally after it is fully dried, the servo may malfunction. In such case, DO NOT continue to use the product, and contact this company for inspection regardless of the normal operation.

### CAUTION

- ⚠ Prior to flying, check the following items for safety:
  - Is there enough battery remaining in the transmitter/receiver? (Is the rechargeable battery fully charged?)
  - Is there any fuel spillage on the receiver, servo, etc. which was caused by leakage from the fuel tank? Is there enough fuel?  
Check that no linkage is in contact with the airplane body. It may cause vibration noise of the airplane. Also, conduct a vibration test by setting the engine (motor) to high while fixing the body and confirm that each control surface moves correctly.
- ⚠ In the case of the initial flight, avoid flying at great distances, choose a safe place, and perform flying practice in the vicinity for several minutes.

## Rechargeable Battery and Battery Charger

Abide by the following to prevent potential leakage, explosion, heat generation, and fire

### DANGER

- ⚠ The battery charger should only be used with an AC100V outlet in Japan.
- ⊘ Always use the dedicated battery charger for charging as supplied with this radio system.
- ⊘ DO NOT use/charge with (+) or (-) set in the opposite direction.
- ⊘ DO NOT place near fire or heat.
- ⊘ DO NOT connect (+) or (-) to any material that may conduct electricity including metals (wire, etc.), carbon materials, etc.
- ⊘ DO NOT disassemble, remodel, or solder.
- ⚠ It may cause a loss of vision if the liquid inside the battery gets into your eyes. Consult a doctor immediately after washing eyes with clean water, and DO NOT rub eye areas.

### WARNING

- ⚠ Failure can be caused.  
Use a genuine JR battery as the rechargeable battery. Stop charging when the specified charging time is exceeded.
- ⊘ DO NOT wet the battery with water or sea water.
- ⊘ DO NOT scratch or tear off the insulating tube, the lead wire, and the connector.
- ⊘ DO NOT use the battery if a scratch is left on the insulating tube, lead wire, and connector, or if the insulating is damaged.
- ⚠ It may damage skin if leaked battery liquid stays on your skin or clothes. Wash away immediately with clean water.
- ⚠ Out-of-control and dangerous situations can be caused.  
The rechargeable battery is composed of a combination of several numbers of batteries. Thus, confirm that all rechargeable batteries inside the pack are in normal state by using a battery checker, etc. Note that the actual battery level of the rechargeable batteries can not be precisely confirmed by testers such as a battery checker. Make sure to judge the state in a comprehensive way by using a battery checker, checking the recharging time, and operating time.

### CAUTION

- ⊘ DO NOT store the battery in a place with high temperature/humidity or dust.
- ⚠ Store the battery out of reach of children.
- ⊘ DO NOT charge the battery in a place with low temperature (below zero degrees Celsius).
- ⚠ Dispose of old batteries according to the local disposal regulations, and do not throw them away in garbage cans, etc.

## Recycling the Rechargeable Battery

Used Li-Fe batteries and nickel metal-hydride batteries are important resources. Place a piece of tape or similar over the terminal areas, and bring them to cooperative stores that collect small rechargeable batteries.

# Contents

## Contents

### Introduction

Greetings, Features .....	1
General Precautions for Safety .....	2-3

### Contents

Contents .....	4
----------------	---

### Preparation

Model Type Sticker / Stick Head / Hook Holder / SD Card /Regarding the Handling of the Batteries .....	5
Names of Each Transmitter Part (Helicopter) .....	6
Names of Each Transmitter Part (Airplane, Glider) .....	7
Methods of Mounting and Removing Batteries .....	8
Stick Spring Adjustment .....	9
Receiver Connection .....	10
Names and Functions of the Input Keys .....	11

### Screens

Initial INFO Screen .....	12
Initial INFO Screen (Telemetry) .....	12.75
My List Screen .....	13
Navigation during Model Setting .....	14

### Function Common to All Models

FLIGHT MODE .....	15
-------------------	----

### Each Function in the Function List

DUAL-RATE & EXPONENTIAL [D/R & EXP] (HELI•ACRO•GLID) .....	16
TRAVEL ADJUST [TRAV. ADJ.] (HELI•ACRO•GLID) .....	17
SUB TRIM [SUB TRIM] (HELI•ACRO•GLID) .....	18
REVERSE SWITCH [REVERSE SW] (HELI•ACRO•GLID) .....	19
SERVO SPEED [SRV. SPEED] (HELI•ACRO•GLID) .....	20
THROTTLE CURVE [THRO CURVE] (HELI•ACRO) .....	21
PITCH CURVE [PIT. CURVE] (HELI) .....	22-23
TAIL CURVE [TAIL CURVE] (HELI) .....	24
GYRO SENSING [GYRO SENS] (HELI•ACRO) .....	25
GOVERNOR [GOVERNOR] (HELI) .....	26
THROTTLE MIXING [MIX→THRO] (HELI) .....	27
THROTTLE TRIM [THRO TRIM] (HELI•ACRO) .....	28
THROTTLE HOLD [THRO HOLD] (HELI) .....	29
SWASH MIXING [SWASH MIX] (HELI) .....	30
FLIGHT MODE DELAY [FM DELAY] (HELI) .....	31
FLAP SYSTEM [FLAP SYS.] (ACRO) .....	32
SNAP ROLL [SNAP ROLL] (ACRO) .....	33
AILERONS → FLAPS [AILE→FLAP] (ACRO) .....	34

ELEVATORS → FLAPS [ELEV→FLAP] (ACRO) .....	35
RUDDER → AILERON/ELEVATOR [RUDD→A/E] (ACRO) .....	36
AILERON → RUDDER MIXING [AILE→RUDD] (ACRO•GLID) .....	37
DIFFERENTIAL [DIFFEREN.] (ACRO•GLID) .....	38
LIMIT ADJUST [LIMIT ADJ.] (GLID) .....	39
FLAP RATE [FLAP RATE] (GLID) .....	40
MOTOR SYSTEM [MOTO SYS.] (GLID) .....	41
CAMBER SYSTEM [CAMB SYS.] (GLID) .....	42
BRAKE SYSTEM [BRAKE SYS.] (GLID) .....	43
FLAPERON MIXING [FLAPERON M] (GLID) .....	44
ELEVATOR → CAMBER MIXING [ELEV→CAMB] (GLID) .....	45
RUDDER → SPOILER MIXING [RUDD→SPOI] (GLID) .....	46
PROGRAM MIXING [PROG.MIX1~6] (HELI•ACRO•GLID) .....	47-48
TIMER [TIMER] (HELI•ACRO•GLID) .....	49
MIXING MONITOR [MIX MONIT.] (HELI•ACRO•GLID) .....	50
SERVO MONITOR [MONITOR] (HELI•ACRO•GLID) .....	51

### Each Function in the System List

MODEL SELECT [MODEL SEL.] .....	52
MODEL COPY & ERASE [COPY/ERASE] .....	53
MODEL TYPE SELECT [TYPE SEL.] .....	54
MODEL NAME [MODEL NAME] .....	55
FLIGHT MODE NAME [FM NAME] .....	56
TRIM SYSTEM [TRIM SYS.] .....	57
STICK POSITION SWITCH [STK POS SW] .....	58
TRIM INPUT SWITCH [TRIM IN SW] .....	59
STICK ALERT [STK ALERT] .....	60
WARNING [WARNING] .....	61
TRANSMITTER SETTINGS [TX SETTING] .....	62
TRAINER [TRAINER] .....	63
FAIL SAFE [FAIL SAFE] .....	64
ALL SERVO HOLD [ALL SV HOLD] .....	65
THROTTLE STICK DIRECTION [STK DIRECT] .....	66
STICK MODE [STK MODE] .....	67
DEVICE SELECT [DEVICE SEL.] .....	68-69
SWASH TYPE [SWASH TYPE] (HELI) .....	70
WING TYPE [WING TYPE] (ACRO•GLID) .....	71-72
BINDING & RANGE CHECKING [BIND&RANGE] .....	73
TELEMETRY [TELEMETRY] .....	74-75

### When Required...

DATA SHEET .....	77-88
SOFTWARE ERROR SCREENS .....	90
Repairs and After-Sales Service .....	91

## Preparation

### Model Type Sticker

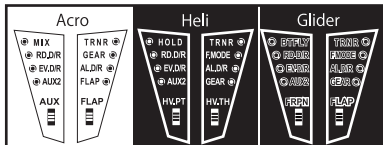

First, affix the sticker of your preferred model type. Remove any dust from the affixing surface, then detach the sticker from the backing paper.

Next, apply the sticker to the transmitter surface, carefully matching the edges with the sticker area marked on the transmitter.

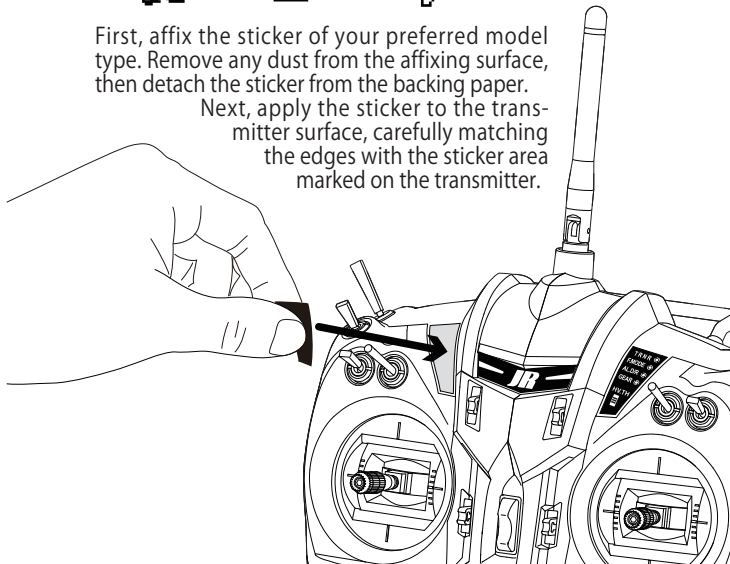

### Stick Head Adjustment

Rotate the hollow (set) screw located at the tip of the stick head to unlock, and rotate the entire stick to adjust to the desired length. When finished, lock it again with the hollow (set) screw.

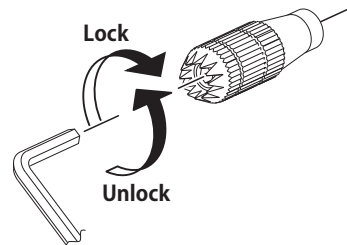

### Hook Holder

For long flights you may choose to use a neck strap.



### SD Card Mounting and Removing Methods

SD Cards that can be used are cards of 16GB or less in size that have been formatted in FAT format.

Mounting and removing SD cards should be carried out after opening the battery cover. The SD card slot is located below the battery.

Further, among the SD cards that are available, some types cannot be used. Please use the JR-SDM2G SD card (sold separately).

#### Mounting Method

Switch off the transmitter, then slowly insert the SD card into the slot taking care of the card direction until you feel a "click".

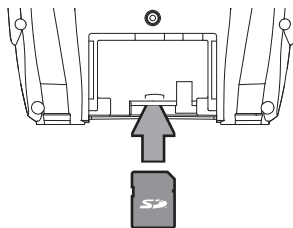

#### Removing Method

Lightly press in the middle of the SD card, then slowly take out the card which will pop out when you remove your finger.

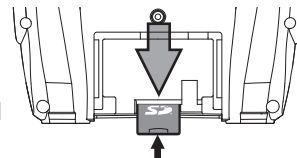

### Regarding the Handling of the Rechargeable Ni-MH Batteries used in the Receiver

Because nickel metal hydride batteries have a high self-discharge rate, battery discharge will gradually take place even when the battery is not being used.

For new batteries and batteries that have not been used for a long time, be certain to carry out charging before use.

In addition, if repeak is repeatedly carried out (charging carried out when the battery has only discharged by a small amount), the battery characteristics will mean that the discharge voltage will be temporarily reduced, and a memory effect may be incurred that will shorten the battery usage time. In this situation, it is recommended that you discharge the battery power once then recharge it before use. Carrying out recharging at high temperatures and low temperatures will be dangerous.

According to the battery characteristics, the charging of nickel metal hydride batteries at high temperatures will cause a noticeable drop in the charging amount. Do not carry out charging inside a car. Further, hydrogen gas may be generated during charging and discharging. Be absolutely certain to avoid carrying out charging close to fire.



# Names of Each Transmitter Part

## Helicopter Type

The names in square brackets [ ] are the abbreviated characters displayed on each Setting screen.

**Important**

! In JR transmitters, each switch and lever is given a name rather than a number. These names and positions will be different depending on the model type. Please take care of this when reading the manual.

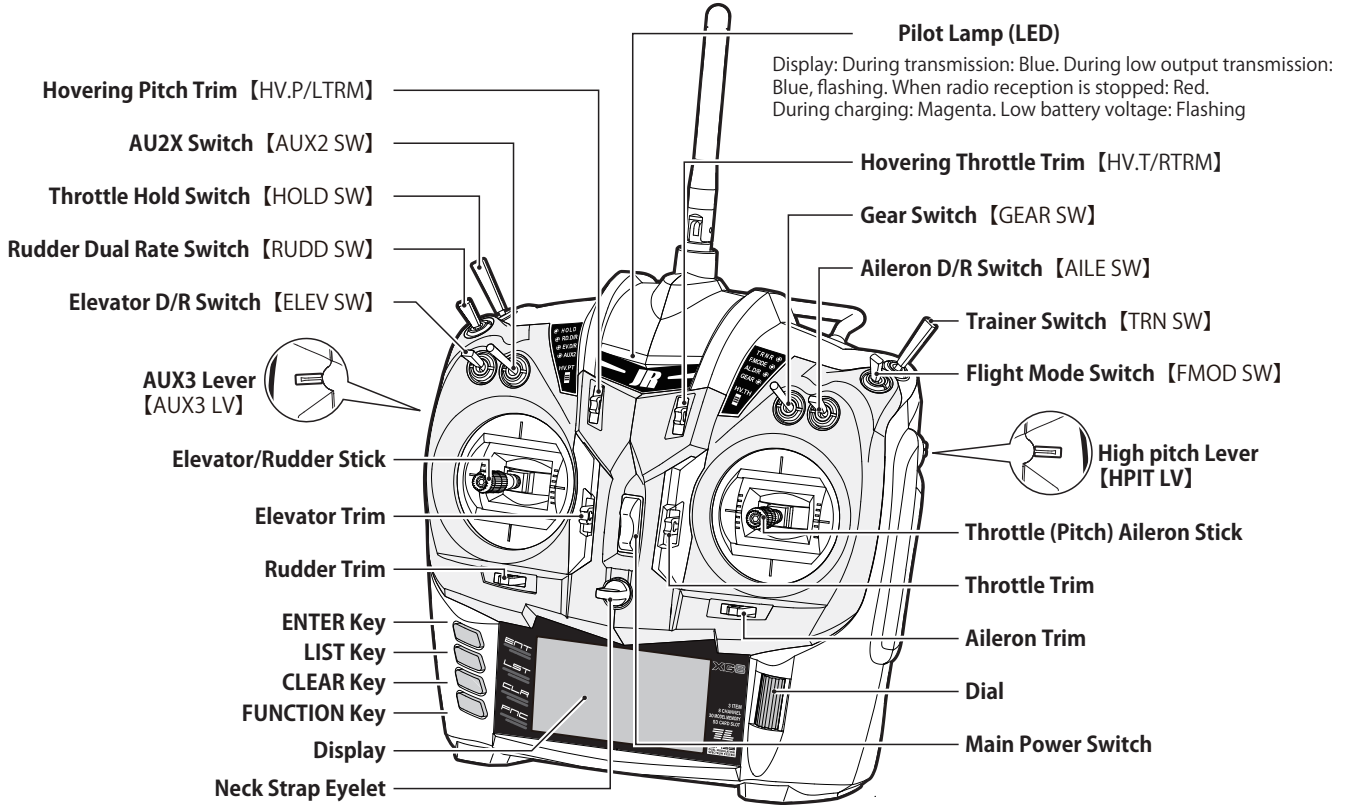

## Backside: Common Models

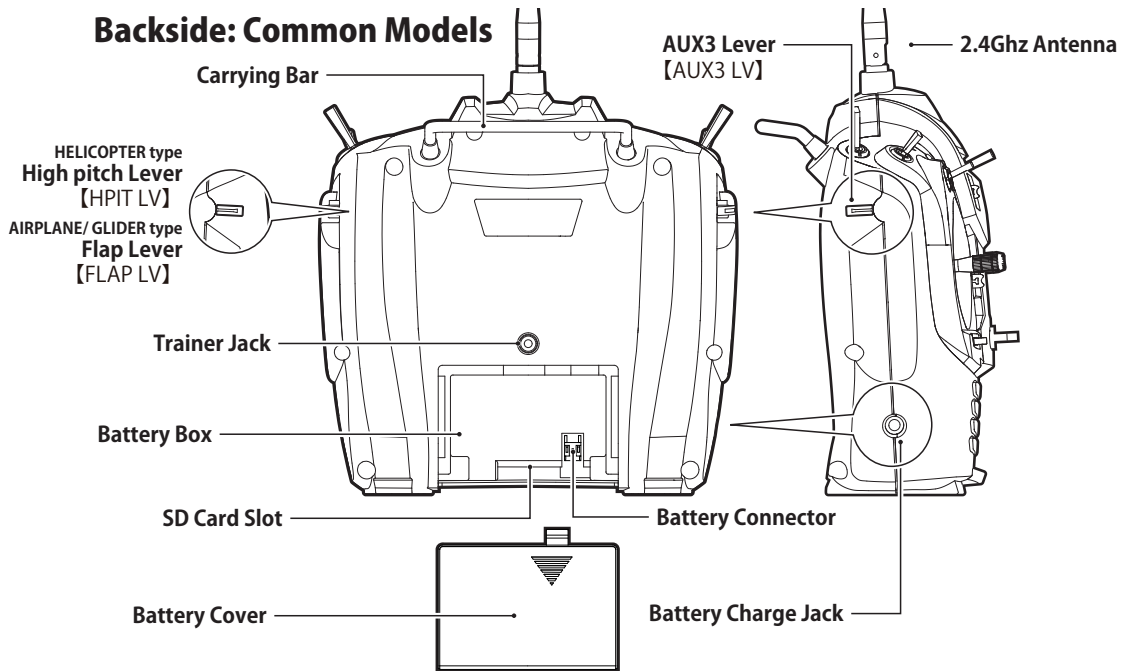

# Names of Each Transmitter Part

The names in square brackets [ ] are the abbreviated characters displayed on each Setting screen.



## Airplane Type

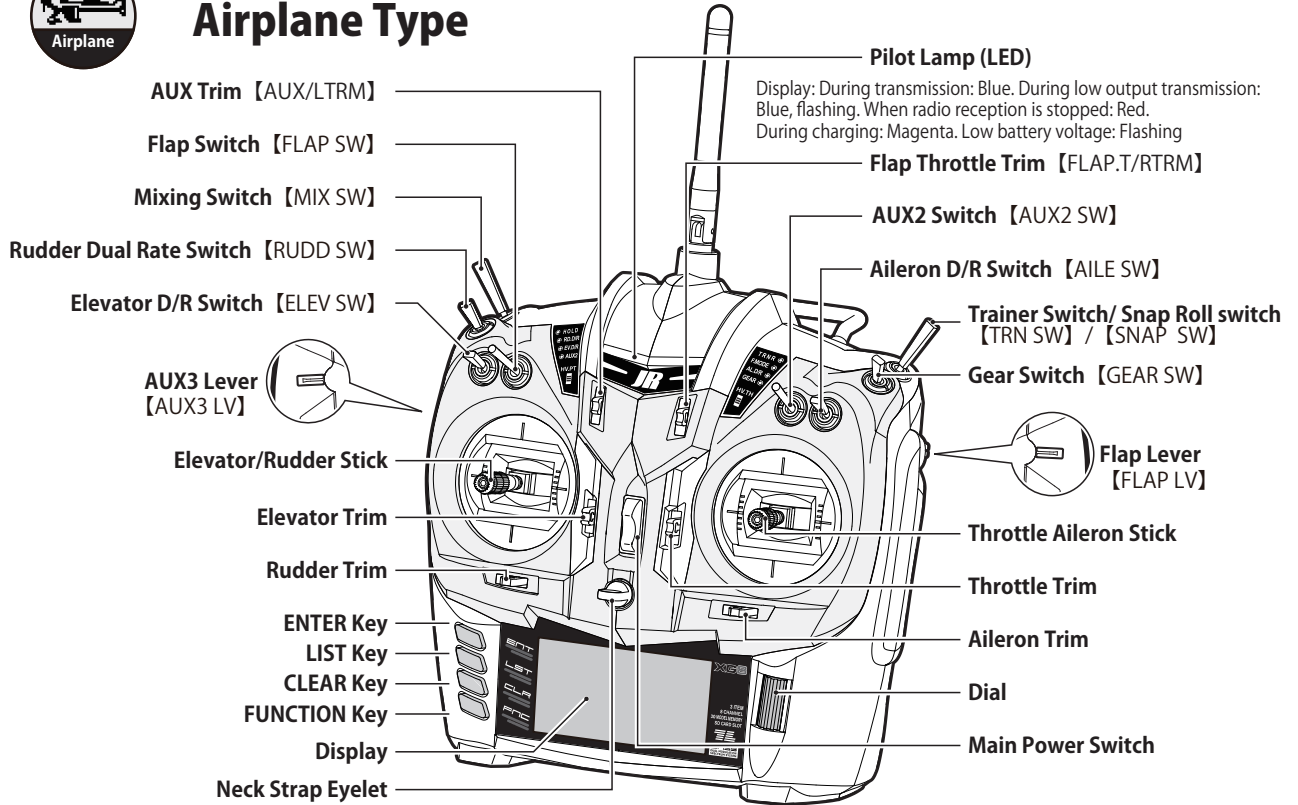

## Glider Type

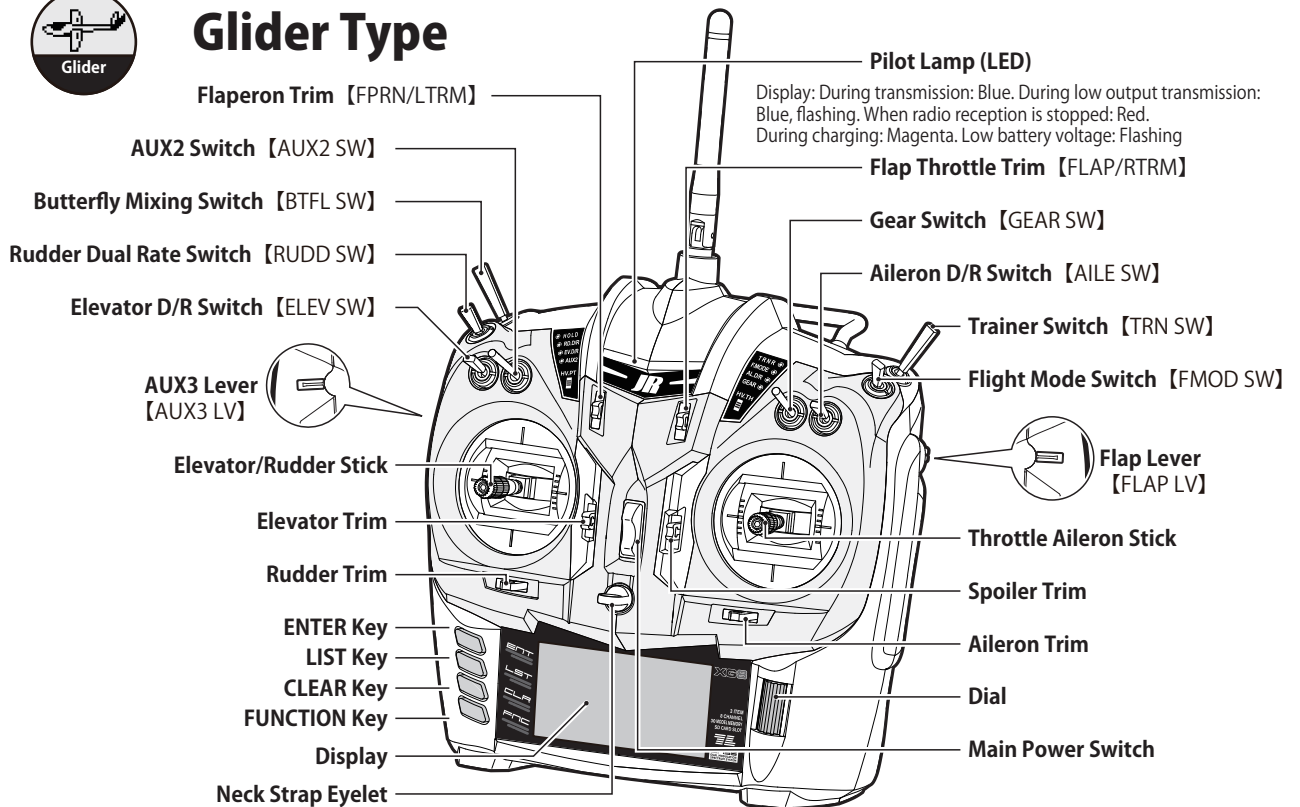



## Preparation

### Methods of Mounting and Removing Batteries

- 1 While pressing the triangle mark on the rear surface battery lid, slide the lid in the arrowed direction and remove the battery cover.
- 2 Insert the rechargeable battery connector into the transmitter battery connector.
- 3 Insert the rechargeable battery into the battery box, and mount the battery cover, taking care not to pinch the lead wires.

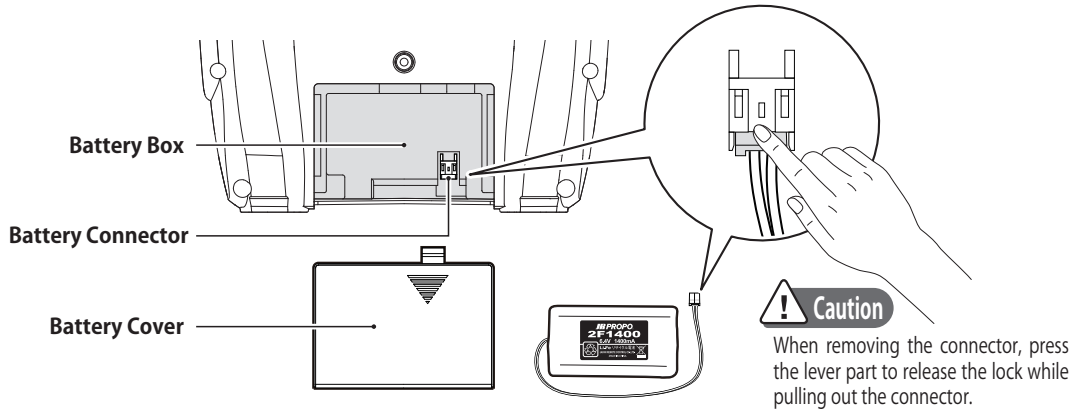

### Method of Charging the Transmitter Battery

Before charging the battery, be certain to read the precautions written on the battery surface sticker. The transmitter operates exclusively with genuine JR Li-fe batteries. Do not use the transmitter with other rechargeable batteries or with dry cell batteries. During charging, the transmitter should be switched off. When the transmitter is in the ON condition, charging will not take place. On the other hand, if the cord is inserted in the Trainer Jack in the condition where the power switch is in the OFF condition, it will be possible to enjoy using the transmitter as a flight simulator using the AC adaptor electric power. Since the built-in battery will not be used, this will allow enjoyment while conserving energy.

- 1 Insert the AC adaptor into the AC electric power socket.
  - 2 Connect the plug of the AC adaptor as far as it will go into the DC power jack of the transmitter.
- ※ In the situation where the transmitter LED does not light, an error will have occurred. In this situation, detach the AC adapter plug once, then re-insert it. In the case where the LED does not light even after the cable has been inserted and removed several times, please contact this company's Service Section.
- 3 During charging, the transmitter LED will light in a reddish purple color. When charging has been completed, the LED will switch off. The standard charging time is approximately 3 hours.
  - 4 After the charging has been completed, quickly detach all of the connections. Absolutely do not leave the battery connected as it is to the power source.
- \* Be certain to use the genuine JR XG8 dedicated AC adapter (NEC-A912). Normal charging cannot be carried out using other AC adapters. Further, do not use this AC adapter for charging other products.

To the AC Electric Power Outlet

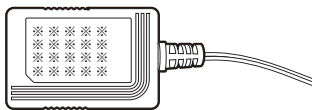

9V12W AC Adaptor for Recharging (NEC-A912)  
\* Caution: This is not a battery charger.

To the Recharging Power Source Jack  
(Exclusively for transmitters with built-in Li-fe rechargeable batteries)



Power source jack for recharging (DC9V)



**Caution**  
Do not use the AC adapter cord while the cord is still bundled together, since there will be a risk of heat generation.

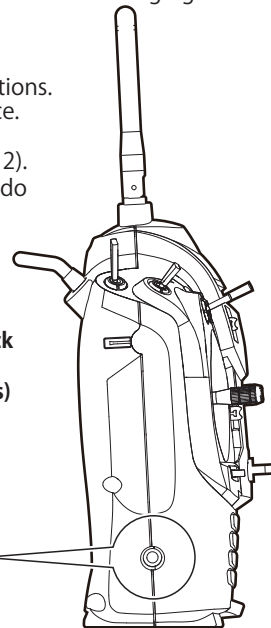

## Stick Spring Adjustment

This allows adjustment of the stick spring strength.

- 1 Be certain to remove the battery before carrying out the adjustment.
- 2 Remove the screws in the eight locations on the rear case.
- 3 Adjust to the desired spring tension strength.  
By adjusting each of the screws, you can achieve the desired strength.
- 4 Close the rear cover, and tighten the screws.  
Take care of the interlocking of the levers, etc.

**! Caution**

Absolutely do not touch the circuit board.  
\* Touching the board may result in electric shock, uncontrolled microcomputer operation, or damage to model data, so that normal operation and handling may become impossible.

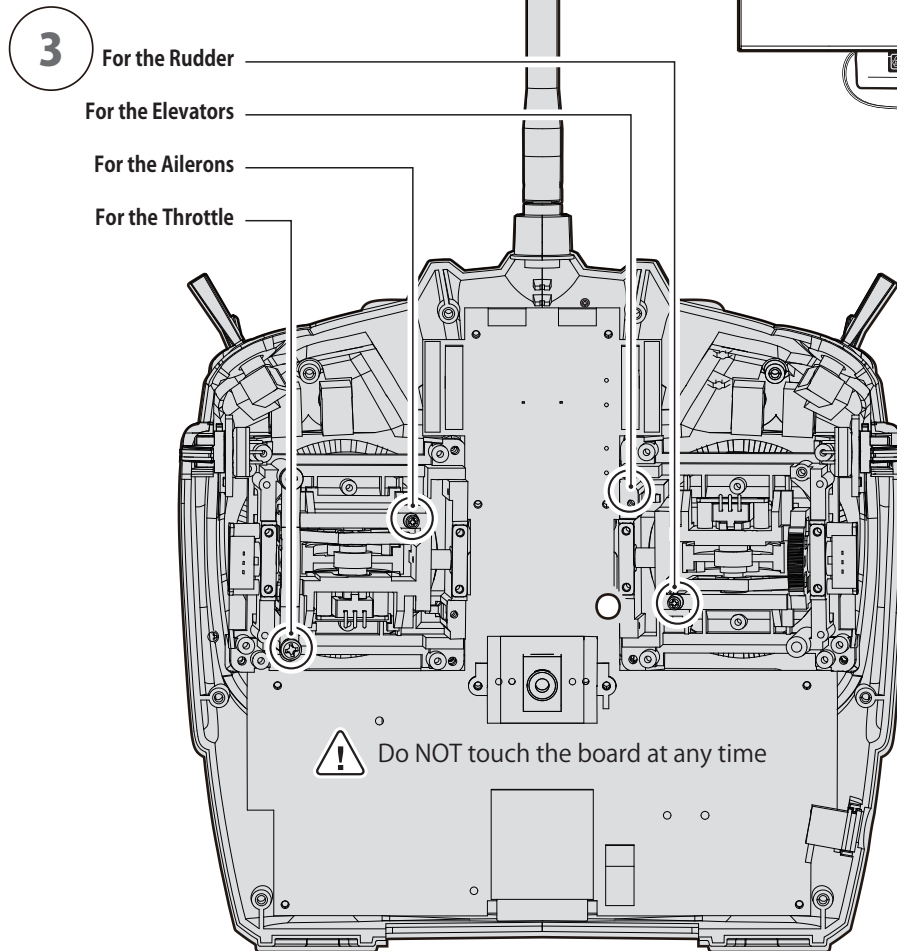
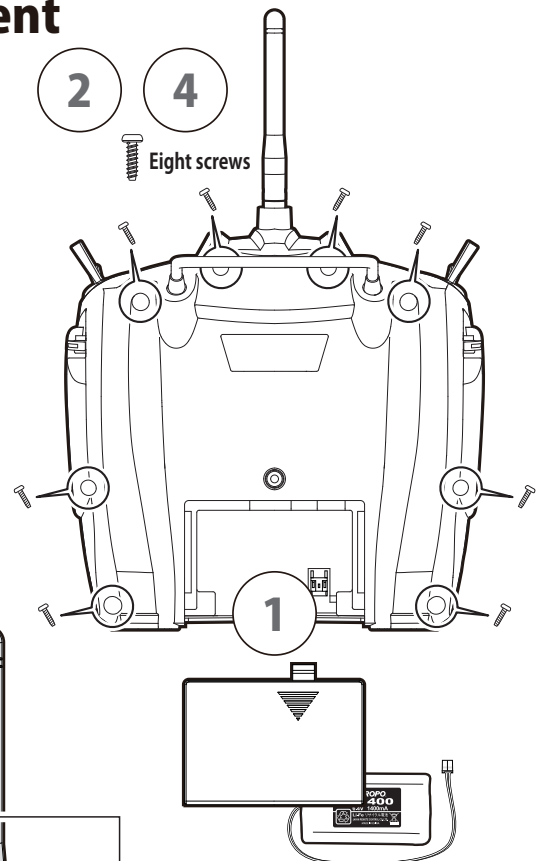

## Preparation

# Receiver Connection

### Concerning the connection and incorporation of the servos and the power source

In JR receivers, the channels for connecting servos are given names rather than numbers. From this point onward in the manual the receiver channels are described using their names, so be careful of this when reading the manual.

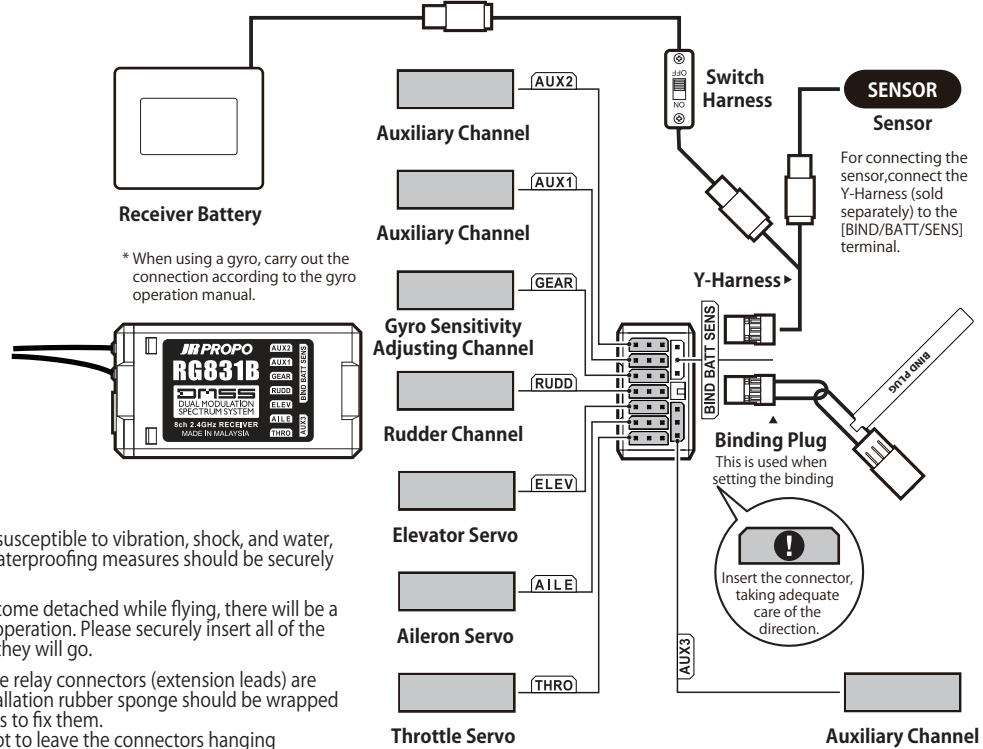

- Since the receiver is susceptible to vibration, shock, and water, anti-vibration and waterproofing measures should be securely implemented.
- If the connectors become detached while flying, there will be a risk of uncontrolled operation. Please securely insert all of the connectors as far as they will go.
- In the situation where relay connectors (extension leads) are used during the installation rubber sponge should be wrapped round the connectors to fix them. Be absolutely sure not to leave the connectors hanging unsupported.

### Concerning the 2.4GHz Band Characteristics and Receiving Radio Wave

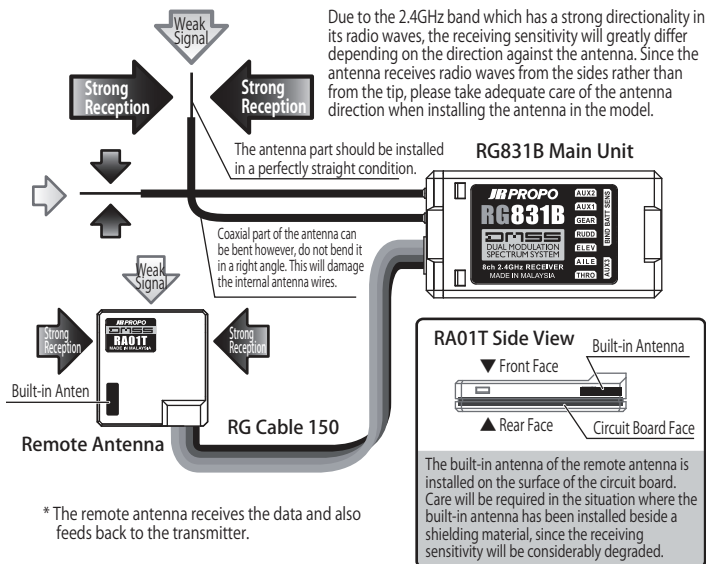

\* The remote antenna receives the data and also feeds back to the transmitter.

### × Wrong Antenna Installation

If each antenna is installed in parallel, the receiving efficiency will be reduced.

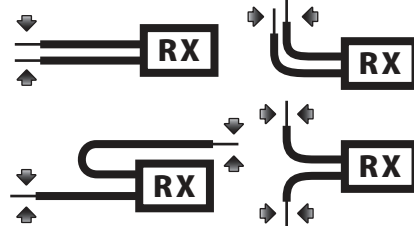

The arrows show the receiving direction with regard to the antenna.

In the case where there are two coaxial antennas in the receiver main unit, the faces of each antenna should be installed so that they are at right angles to each other, rather than being parallel. Note that in order to allow certain and stable communications to be carried out, it is recommended that each antenna should be installed with a separation of 30mm or more.

### DO NOT bend the antenna tip!

The antenna part (30mm) should be installed perfectly straight. If bent, stable receiving will not be possible.

In the situation where the antenna has been attached directly to a shielding material such as carbon or metal, the receiving sensitivity of the installed antenna surface will be considerably reduced. When the antenna is to be installed on this kind of shielding material, either separate the antenna as far as possible from the material, or in the case where the radio wave shielding material is the aircraft body itself project the antenna outside the aircraft body.

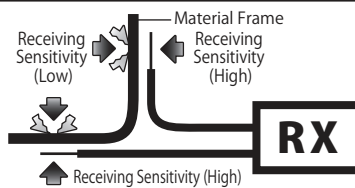

\* Take care not to damage the antennas projecting from the aircraft body.

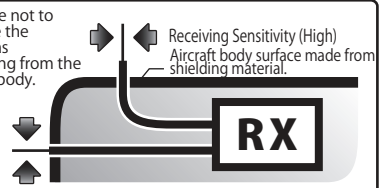

## Names and Functions of the Input Keys

In addition to the standard button keys for input, this transmitter employs a dial. At the time of setting, almost all operations can be done by the dial intuitively. Basic operation for the dial is rotating to the right or left, and pressing (click).

- A "click" sound is heard for confirmed input when the input is valid.
- A "click" sound may be heard without causing any change in numerical numbers on the display. This is because numerical numbers below the decimal point are not displayed while the set value is actually changed internally.
- As to the button keys on the left side of the transmitter, they operate as displayed when a triangular arrow is displayed on the LCD. When the name of the key (abbreviated) is displayed on the LCD, the key will function as displayed.

The key display in this manual is as shown in the figure below.

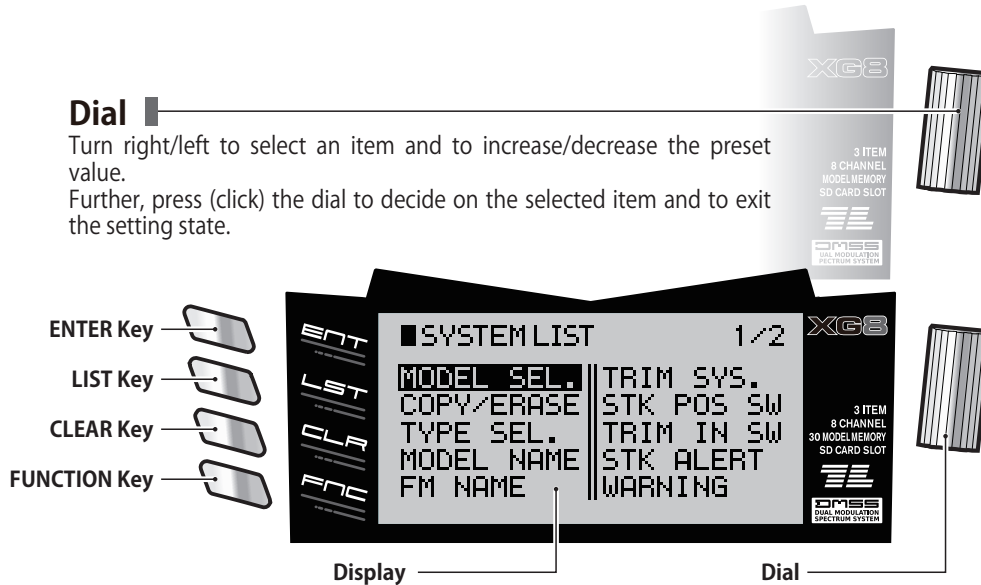

- ENTER Key**  
 If this key is pressed when the INFO screen is being displayed, the screen will change to the My List screen. This can be used for moving to each of the other functions.
- LIST Key** In function fixing, when this key is pressed the screen changes to the Function Listing screen.
- CLEAR Key**  
 Although this key basically initializes the preset value, it operates as displayed when an item other than an arrow is displayed on the screen.
- FUNCTION Key**  
 Though this key has no allocated function, it operates as displayed when an item is displayed on the screen  
 Ex.: Timer start/stop key etc.  
 Also, when this key is pressed at the time of entering numbers with a dial, the number changes at ten times the normal speed.

## Initial INFO Screen

- This INFO screen is displayed when the power switch is switched on. The screen has a two-page configuration, and rotating the dial to the right moves forward to the Telemetry screen. When you wish to return to the Initial INFO screen from the Telemetry screen, rotating the dial to the left returns to the Initial screen.
- The Telemetry screen allows display of the information from sensors attached to the receiver as well as Timer and Flight Mode information. It is possible to select required items and display them. (Note: In each flight mode)

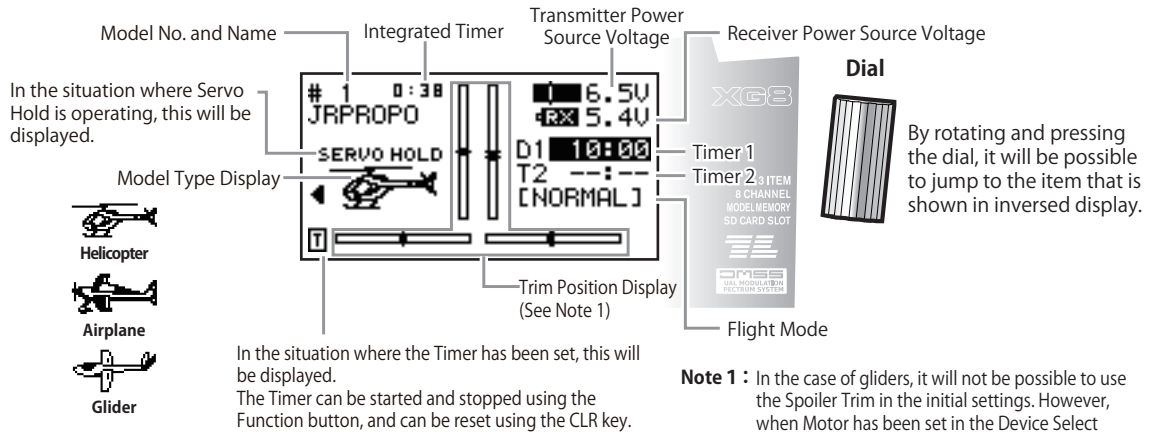

**Hint** In the case of helicopters, if the Flight Mode position is selected and the dial is pressed, it will be possible to select other Flight Modes so that the Trim Adjustment in other Flight Modes can be carried out even without actually flying the aircraft.

## Pages Accessed from the Initial INFO Screen

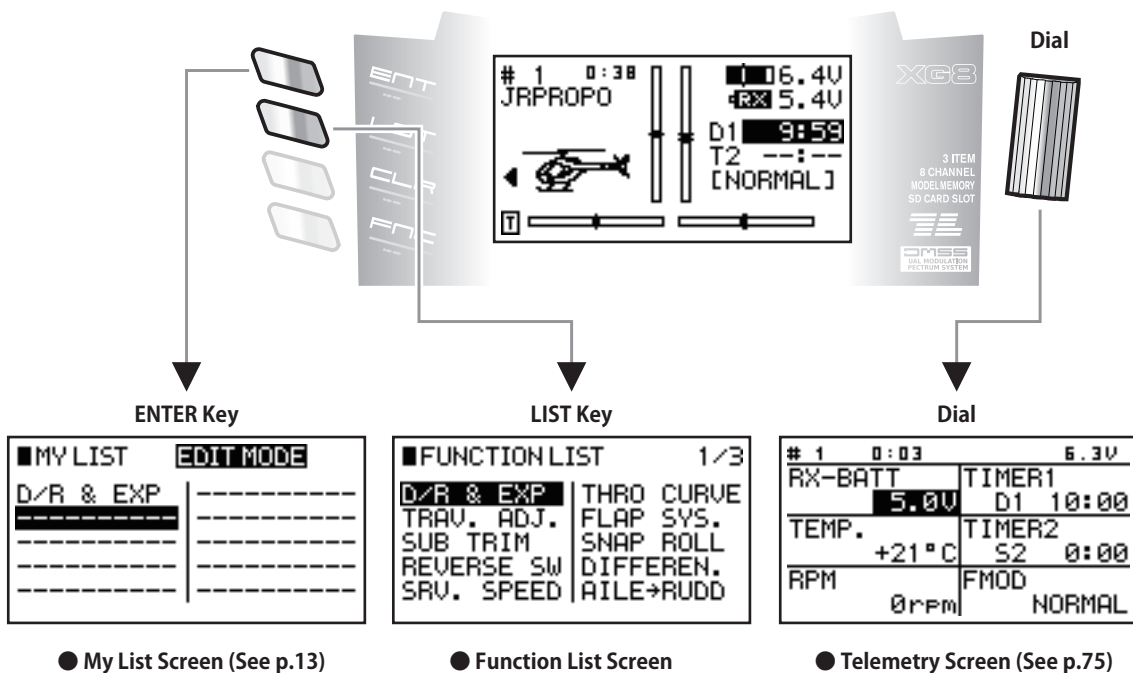

# My List Screen

## My List Function

Frequently used functions can be selected and displayed on the My List for quick access. Press the **ENTER** key during normal screen mode to change to My List display. Nothing will be displayed on the My List in the default condition.

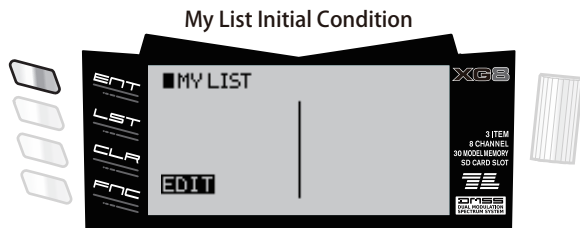

To add functions to this list, press the lower-most **Function key**. (The display will be shown while "EDIT MODE" flashes.)

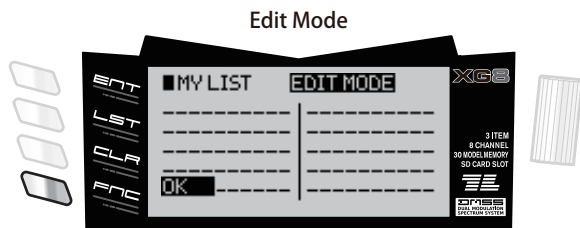

Rotate the dial to move the cursor to the desired position and press the dial to display the items that can be added to the list. Rotate the dial to move the cursor to the item that you wish to add and press the **dial**.

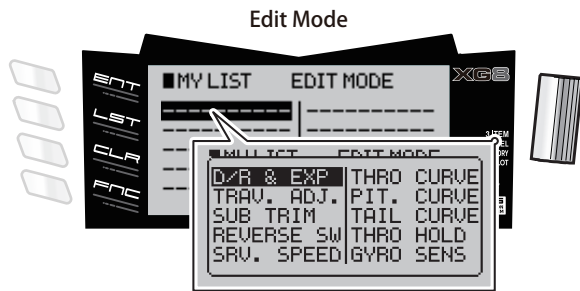

Function Selection Screen

By returning to the Edit Mode and pressing the **Function key**, the inputting will be completed. In the situation where you wish to delete a function from the My List, move the cursor above the item and press the **Clear key**.

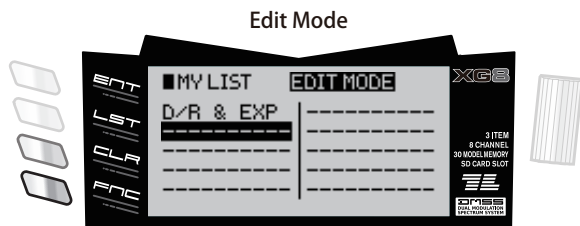

## Navigation during Model Setting

When a new model has been created, or when the model type has been changed, the necessary basic setting screens will be automatically displayed in order.

- Complete each of the settings following each guide.

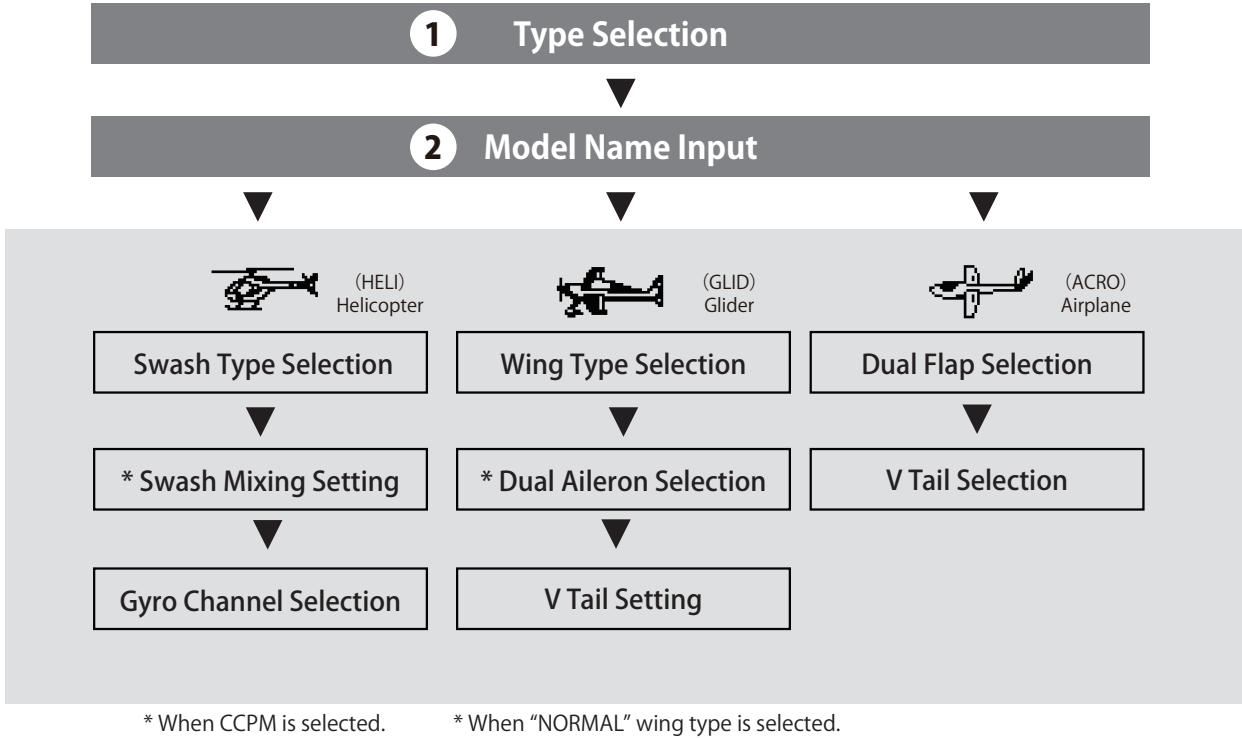



# FLIGHT MODE

## Function Explanation

- The Flight Mode function allows switching between the various aircraft settings in a one-touch operation using the switches. This means it will be possible to switch the aircraft flight characteristics using one-touch operation.
- The flight modes that can be switched consist of a maximum of six flight modes of helicopters, up to three flight modes of airplanes, and a maximum of 5 flight modes of gliders.
- The current Flight Mode will be displayed on the Initial INFO screen, where it can be confirmed. In addition, it will also be possible to change the displayed name using the Flight Mode Name screen in the System List.

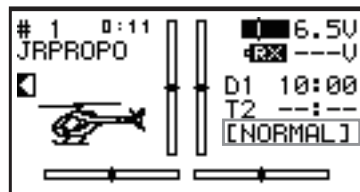

Current Flight Mode

### Important

- ! At the time of shipment, the Flight Mode switches in the airplane and glider models are not set. Set the switches allocated in the Flight Mode using the Device Select screen.

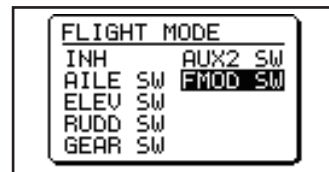
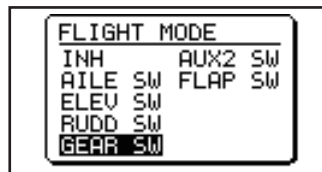
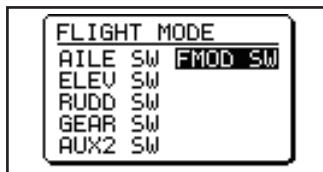

## Items that can be Changed in the Flight Mode

- Basically, this function displays each of the Digital Trim positions and the settings in each of the function screens in Function List using [SW SEL].

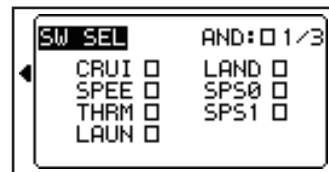
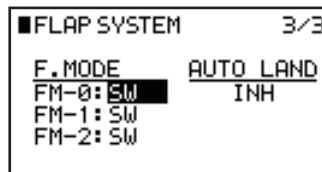
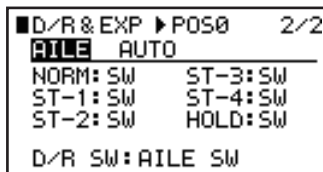

### Hint

- The displayed names in each Flight Mode will be different for airplanes, helicopters, and gliders.





# DUAL-RATE & EXPONENTIAL [D/R & EXP]



## Function Explanation

- This function carries out switching of the aileron, elevator, and rudder control surfaces between the control surface angles and curves using the Dual Rate switches. By combining the control surface angles with the exponential settings, it will become possible to carry out each of the various independent settings so that the aircraft response can be changed. Exponential is a curve adjusting function that logarithmically changes the servo action in response to the stick action, allowing the movement in the vicinity of the neutral position to be adjusted from mild (+ direction) to quick (- direction) without changing the maximum control surface angle. The setting condition of the adjustments can be confirmed using the graph.



## Setting Method

- The Setting screen has two pages. In page 1, rotate the dial to move to and select items on the screen that can be set (shown in inverse display). Then press the dial to display the setting box and carry out setting of the numerical values. By operating the stick, the setting condition can be confirmed using the screen graph.

### Page 1 Screen

This displays the position in this function

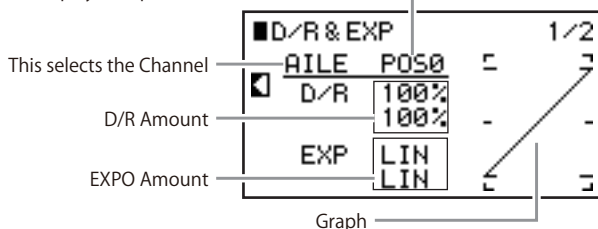

Ex.: Setting box display when the Dual Rate amount has been selected.

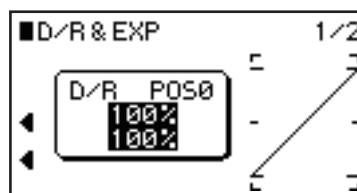

### Page 2 Screen

This screen sets the desired fixed positions or the operations using each switch in each of the Flight Mode positions. In this situation, if "SW" is set, position switching will be carried out using the switch that has been selected at the bottom of the screen.

After the setting, carefully confirm the settings using the Page 1 or Page 2 screens.

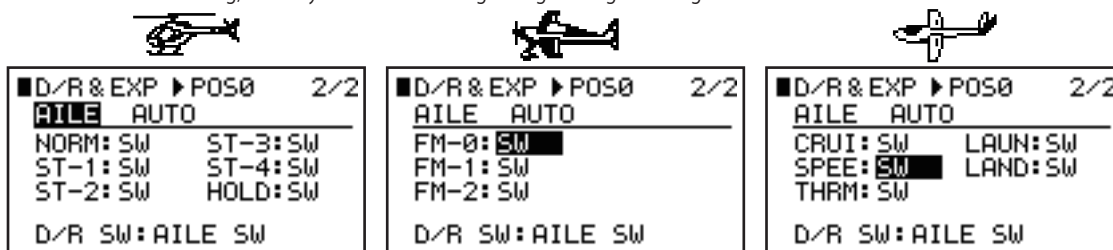

In the situation above where "SW" has been selected, it will be possible to choose which of the switches will operate.

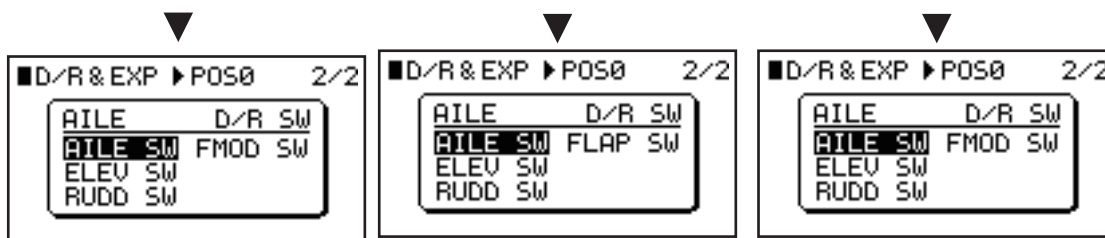

### Hints

- The Dual Rate setting numerical value should be between 0 and 125, and EXPO should be between 0 and 100.
- Using the stick operation, the inverse display numerical values can be shown separately inverted to the left and right (up and down), so that the control surface angles and curves can be individually adjusted.
- The setting values can be reset using the CLR key.
- In the situation when selecting the switch, the switch will be automatically input if you actually operate the switch that you wish to use in the Selection screen.

### Caution Item

- ⚠️ Actually operate the servos and carefully confirm the settings before flying.



# TRAVEL ADJUST [TRV. ADJ.]



## Function Explanation

- This function allows adjustment of the servo left-right (and up-down) control surface angles for each channel separately. The angle adjustment is carried out referenced to the neutral position. Adjustment is possible over an adjusting range between 0 and 150% for each of the left-right (up-down) directions. The standard value is 100%, and this is the normal control surface angle.



## Setting Method

- The setting screen has two pages, with four channels on each page. Rotate the dial to move to and select the items that can be set (shown in inverse display). Then press the dial to display the setting box and carry out setting of the numerical values. By operating the sticks or switches, the screen display will show separated inverse displays so that it will be possible to carry out adjustment in the desired direction. In the situation where both directions are shown in inverse display, it will be possible to adjust the left and right control surface angles simultaneously.
- \* The channel names will differ according to the model type.

The screen shows a helicopter model.

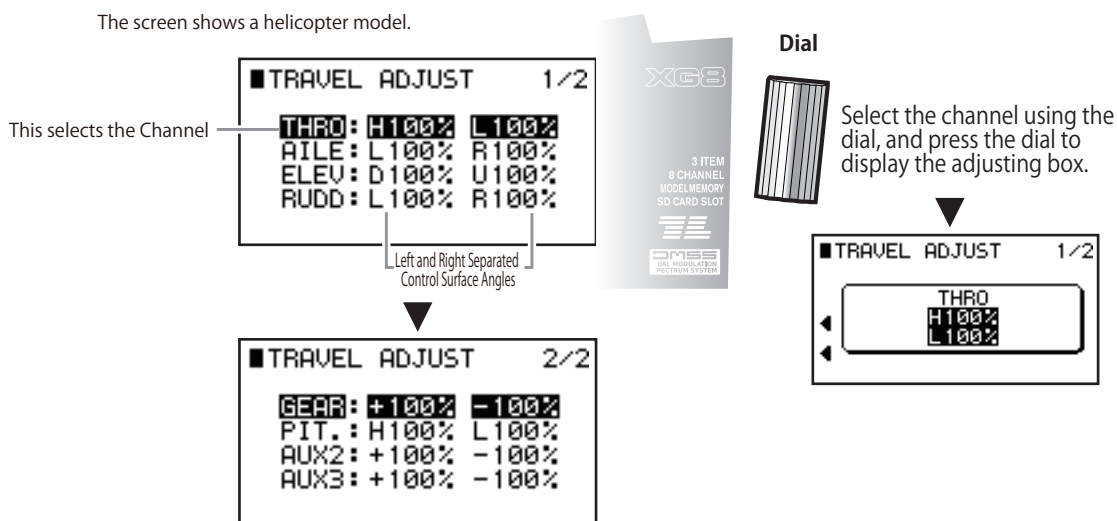

### Caution Items

- ! Actually operate the servos and carefully confirm that the linkages are not locked before flying.

## Each Function in the Function List



# SUB TRIM [SUB TRIM]



## Function Explanation

- This is the auxiliary trim of the servos attached to each channel. This trim should be used as a fine adjustment when the servo horn mounting angle does not become 90 degrees with regard to the linkage. Note that if this is moved by an overly large amount, it will affect the maximum control surface angle of the servo. It is therefore recommended to make the smallest possible adjustment.



## Setting Method

- Rotate the dial to move to and select the channel that you wish to set (inverse display). Then press the dial to display the setting box, and carry out the numerical value setting. Although the adjustment numerical value range is  $\pm 340$ , this will be the numerical value in the detailed steps exclusive to this screen, and will differ from the numerical values on other screens.  
\* The channel names on the screen will differ according to the model type.

- The screen shows a helicopter model.

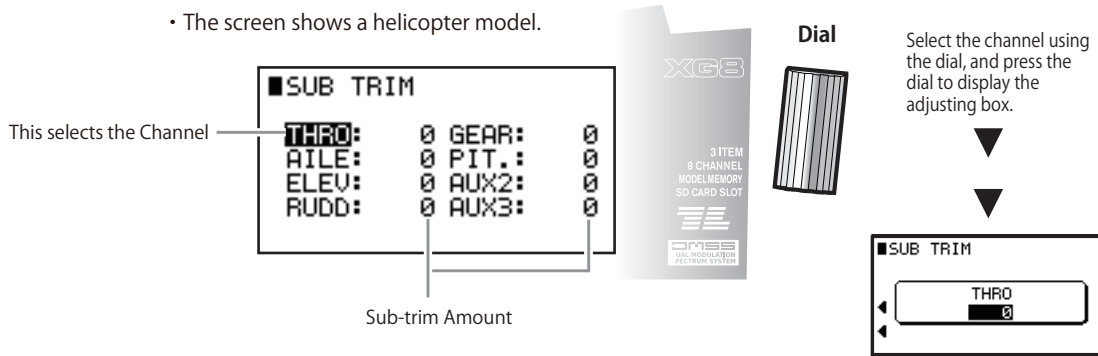

### Caution Items

- ! Actually operate the servos and carefully confirm that the linkages are not locked before flying.

## Each Function in the Function List



# REVERSE SWITCH [REVERSE SW]



## Function Explanation

- This function reverses the servo operating direction (pulse change direction) of each channel.



## Setting Method

- Rotate the dial to move to and select the channel that you wish to change (inverse display). Then press the dial to select the rotation direction.  
\* The channel names on the screen will differ according to the model type.

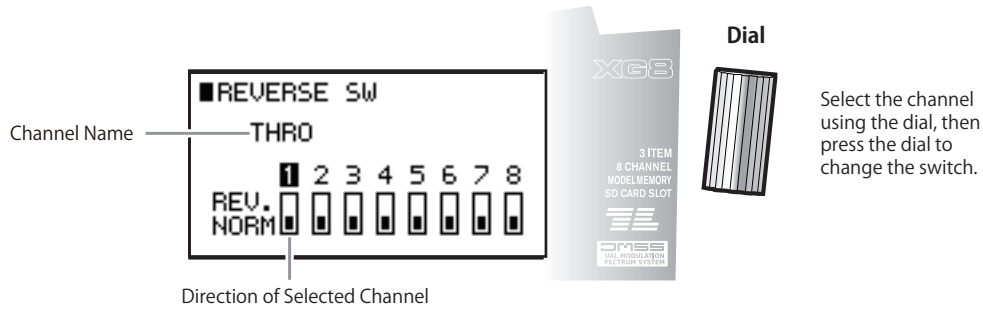

## Important Caution Item

In the situation where the reverse switch setting has been changed in the condition where the Fail Safe has been set, because this will also affect the Fail Safe operation, it will operate in the opposite direction to the condition that was set.

**Accordingly, in the situation where the Fail Safe has operated after the throttle channel has been set to reverse by setting the reverse switch in the aircraft body, the servo will be set to**

**the Full High side, which will be extremely dangerous.**

After finishing the transmitter settings, be sure to implement the Fail Safe settings (Match the stick to the position that you wish to set and press the Memory key), and **be certain to carry out operation confirmation.** (Switch off the transmitter once, and check whether the servo movement reaches the correct position.)



# SERVO SPEED [SRV. SPEED]



## Function Explanation

- This function slows down the operation speed of the servos of each channel. For operations at speeds slower than the set speed, the function will not operate. This function should be considered as a speed limiter. The speed setting can be set separately to the left and right (up and down) from the neutral position. Additionally, the setting can be set to ON/OFF in each Flight Mode or using optional switches. Further, this function is similar to the Stick Position switch, and ON/OFF can be carried out using a desired throttle stick position (except in the case of gliders).  
\* The screen channel names will be different for each model type.

## Setting Method

- The setting screen has three pages. In Pages 1 and 2, the speed settings in each of the channel directions are carried out, while Page 3 is the setting screen for the operation switches. Rotate the dial to move the inverse display area and select the channel, then press the dial to display the setting box, and carry out the speed setting. "NORM" is the fastest setting, and the speed can be slowed between 0.1-15.0 seconds. This indicates the time that the servo takes to rotate through 60 degrees. However, there may be some slight differences depending on the servo.

● **Page 1 and 2 Screens** The screens show the displays for helicopter models.

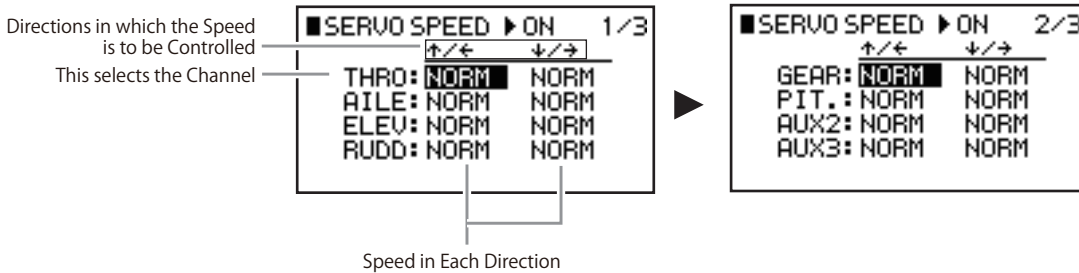

### ● Page 3 Screen

This allows selection of the switches that this function switches ON/OFF. The ON/OFF operation condition is displayed on the screen.

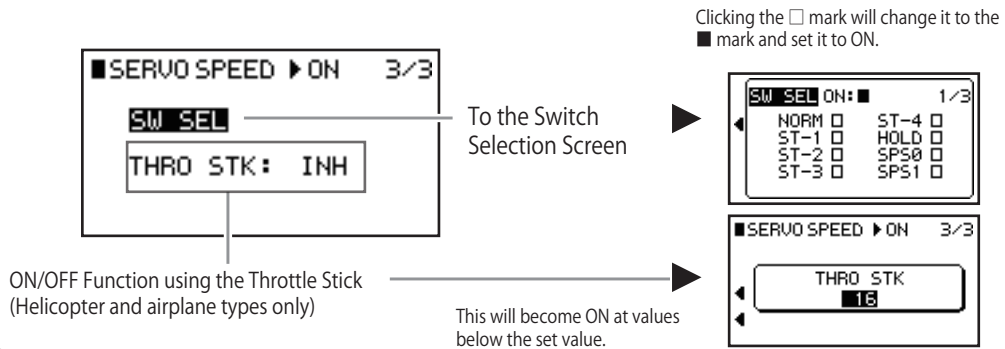

## Hints

- Depending on the application, channels having invalid servo speeds will be displayed as "----" and will not be possible to set.
- The setting values can be reset by pressing the CLR key.
- Because position inputting will also be carried out in this Switch Selecting screen, automatic setting using switch operation will not apply.

### Caution

- ! When the switches have been set, carefully confirm the servo speeds using actual switch operation.



# THROTTLE CURVE [THRO CURVE]

## Function Explanation

- This function adjusts the servo operation in response to the throttle stick operation. The stick operations can be set to servo positions corresponding to a maximum of 5 point positions. In addition, an EXPO (exponential) function is also incorporated to allow smooth connection of each of the points. This curve setting allows setting of a maximum of 5 models in each Flight Mode for helicopters, and one model for airplanes.

## Setting Method

**Caution** When switching to this screen, for safety reasons you will be asked whether all servos should be fixed. After confirming this, the screen will change to the Setting screen. In the situation where the servos have been fixed, in order to exit from the Adjusting screen the throttle stick should be set to the slow side, and in the case of helicopters it will also be necessary to set the Flight Mode to "NORM".

- The initial curve setting points are three points set to the slow, center, and high sides. To add a point, set the stick to the desired position and press the "ADD" key. In the situation where the point is to be deleted, this should be carried out using the "DEL" key. The figure shows the situation where the number of points has been increased to 5.

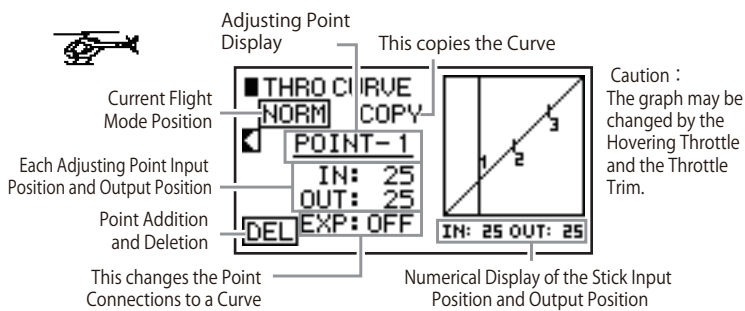

## Setting of Each Item

- Rotate the dial to move to and select the item (inverse display). Then press the dial to display the setting box, and carry out the numerical value setting.

Example of Settings Box



The setting condition can be confirmed using the graph on the screen.



- In the airplane (ACRO) models, it will be possible to select the switches that switch ON/OFF this function. Rotate the dial until "SW SEL" is displayed, then press the dial and select the switch from the Switch Selecting screen.

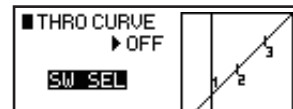

- Selecting the Switches that Switch ON/OFF the Function

Click on each  mark to change it to  and set it to ON. If "AND" is clicked, only one location will be set to ON inside each switch position.

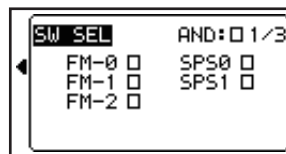

## Hints

- The setting values in this function are all between 0 and 100.
- The input positions (IN) can also be adjusted using the dial. In addition, when inputting the points of the output positions (OUT), it will be possible to select and adjust the points using the throttle stick.
- If the engine and motor torque band are set so that they can be effectively utilized, the handling will become simple.
- The screen display contents will differ slightly according to the model type.

### Caution Items

- Even if the Hovering Throttle Trim is operated, affecting the graph, each of the point output numerical values will not change. The numerical values below the graph will be influenced by the operation.
- Actually operate the servos and carefully confirm the settings before flying.



# PITCH CURVE [PIT CURVE]

## Function Explanation

- Because the basic operation conforms with the Throttle Curve, please ensure that you clearly understand the Throttle Curve before using this function. This function adjusts the pitch action with regard to the throttle stick operation. The stick operation can be set to a curve corresponding to a maximum of 5 point positions. In addition, an EXPO (exponential) function is also incorporated to enable the smooth linking of each of the points. This curve setting allows setting of a maximum of 6 types in each Flight Mode.

## Setting Method

**Caution** When switching to this screen, for safety reasons you will be asked whether all servos should be fixed. After confirming this, the screen will change to the Setting screen. In the situation where the servos have been fixed, in order to exit from the Adjusting screen the throttle stick should be set to the slow side and the Flight Mode should be set to "NORM".

### Input Points

The initial input setting points are three points set to the slow, center, and high sides. To add a point, set the stick to the desired position and press the "ADD" key. In the situation where the point is to be deleted, this should be carried out using the "DEL" key. The figure shows the situation where the number of points has been increased to 5.

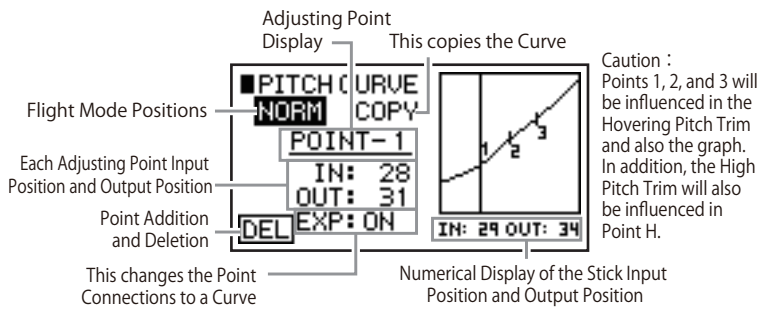

### Flight Mode

Using Flight Mode switch operation, the display can be switched and curve setting can be carried out. In the situation where extension switches have been set in the Flight Mode, 6-type switching will be possible. Further, if the dial is pressed in this situation, setting will be possible of the switching to the graph of each mode even if the Flight Mode switches are not operated.

### High Pitch Trim Lever

Using the lever on the side of the transmitter, H point pitch adjustment will be possible. Because this will initially be set to "INH", this should be changed to "ACT". Then select the lever either on the left or right side of the transmitter using "INPUT". The lever should normally be left in the center position, and should be used for emergency adjustment. In addition, "RATE" shows the High Pitch lever movement amount.

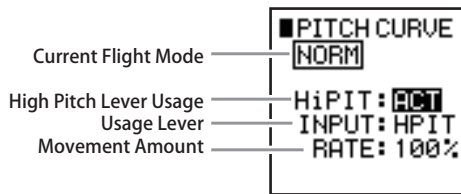

### Caution Items

- The input positions (IN) can also be adjusted using the dial. In addition, when inputting the points of the output positions (OUT), it will be possible to select and adjust the points using the throttle stick.
- Even if the Hovering Throttle Trim or High Pitch Trim operation affects the graph, each of the point output values will not change. The OUT numerical values below the graph will be influenced by the operation.
- After the setting, operate the servos and carefully confirm each of the Flight Mode settings before flying.



# PITCH CURVE Continued [PIT CURVE]

## Examples of Setting the Pitch Curve and Throttle Curve

- Examples of the Throttle Curve and Pitch Curve settings in aerobatic specifications are shown in the graphs. However, these are only a few examples, and the settings will be different according to the specifications of the aircraft being used. In addition, Idle Up should be set considering the neighborhood of Point 2 as the zero pitch.
- Because the full stroke from throttle idling to the fully open condition and the pitch full stroke during Autorotation will be taken as between 0 to 100%, it will be easy to understand the type of curves that will be formed by the throttle and pitch according to the displayed numerical values. Further, it will also be easy to consider other curves.

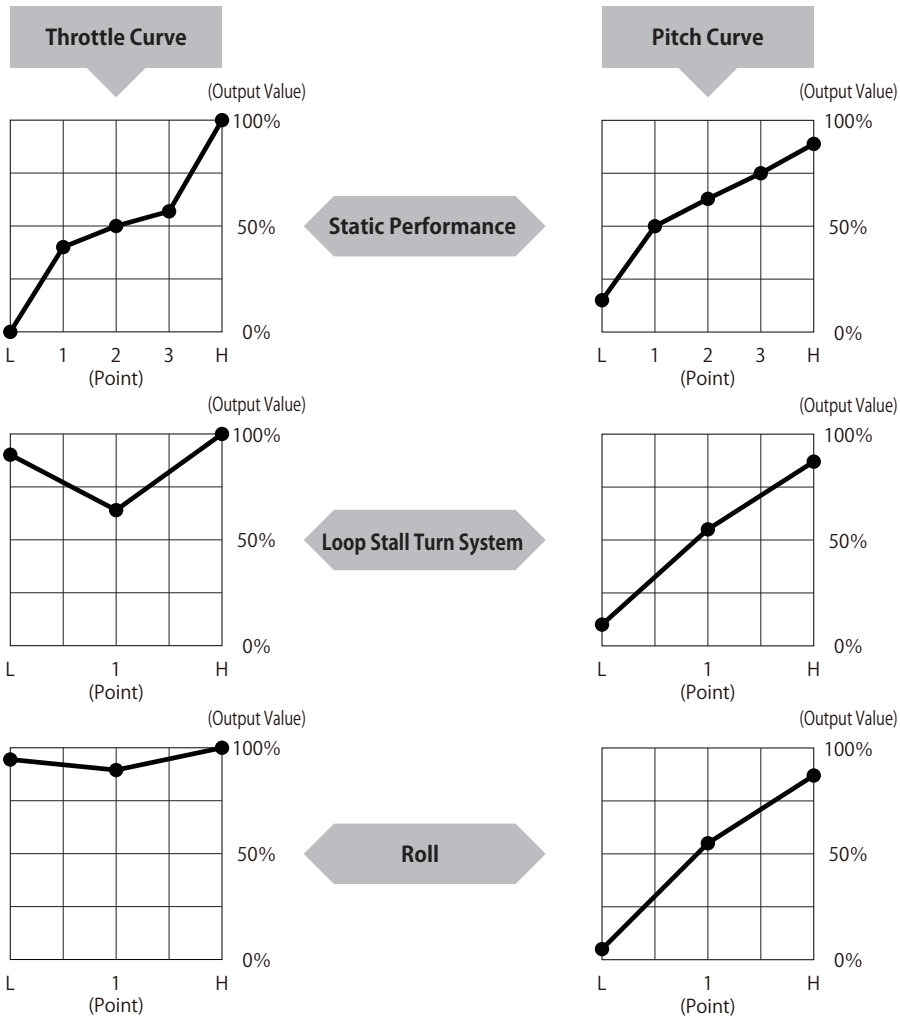

### Hint

- In the throttle curve examples in the figures above, the reason why Point L rises above the high side of Point 2 is as follows. If the pitch curve is set to zero pitch at Point 2, the pitch at the L point will increase as a reverse pitch. For this reason, loading will be applied. Because it will be necessary not to greatly change the rotation speed even at this time, this is the reason why the throttle will have to be increased.





# TAIL CURVE [TAIL CURVE]

## Function Explanation

- This is the mixing between the pitch and the tail servo. It is also known as revolution mixing. It allows setting of the mixing amounts separately up and down from the hovering point. Intermediate points can also be established in each direction, so that setting can be freely carried out. In addition, Mixing Rate setting, which is convenient for detailed adjustment of stunt positions, will also be possible. A maximum of 5 types of setting curves can be set in each Flight Mode.

## Setting Method

**Caution** When switching to this screen, for safety reasons you will be asked whether all servos should be fixed. After confirming this, the screen will change to the Setting screen. In the situation where the servos have been fixed, in order to exit from the Adjusting screen the throttle stick should be set to the slow side, and the Flight Mode should be set to "NORM".

### Input and Output Points

The numerical values of each point can be set. The initial input setting points are three points set to the slow, center, and high sides. To add a point, set the stick to the desired position and press the "ADD" key. In the situation where the point is to be deleted, this should be carried out using the "DEL" key. The figure shows the situation where the number of points has been increased to 5.

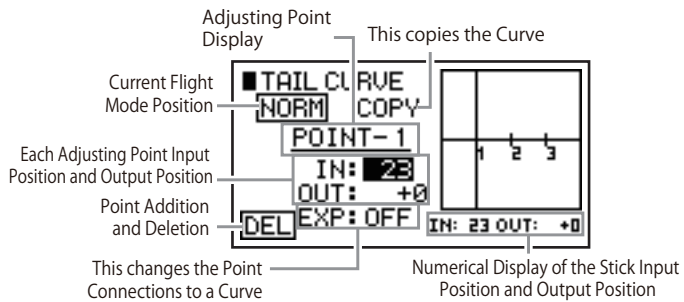

### Input Pitch Correction

The pitch information that is input to the mixer can be selected from the following two types.  
 "NORM": This is the stick position referenced to the curve set using the Pitch Curve function.  
 "ORIG": This is the stick position itself.

### Mixing Rate in Stunt Mode

This display will be shown when the Flight Mode is set to stunt positions. It means that even though the graph and output figures will remain the same, an action will be implemented that reduces the actual mixing amount by the multiplier described below. Accordingly, it will allow more detailed adjustment. However, it will become the stunt mode common multiplier.

- 「1/1」: ×1
- 「1/2」: ×0.5
- 「1/4」: ×0.25
- 「1/10」: ×0.1

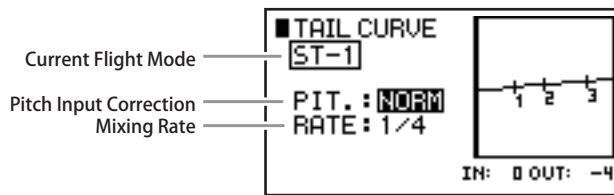

## Caution Items

- When using the Tail Lock Gyro (Heading Lock), this function will not be required since the tail will be automatically corrected. Each of the setting values must be set to zero.



# GYRO SENSING [GYRO SENS]



## Function Explanation

- This function controls the gyro sensitivity using the GEAR channel and the Auxiliary (AUX) channel. It has a function for adjusting the gyro sensitivity from the transmitter. Response is provided from a mode that allows setting of tail lock sensitivity to normal sensitivity using one channel to also support "Dual Gain" as employed in JR's G7000 where setting is carried out using two channels. Further, use with two gyro units is also possible. The sensitivity switching of each unit can be set using each switch and also in the Flight Mode.

## Setting Method

- Depending on the settings, the Setting screen may have a maximum of 3 pages, and the displayed items may also change. Rotate the dial to move to and select the item that can be set on the screen (inverse display). Then press the dial to display the setting box, and carry out the numerical value setting.

1 In the last page of the screen, set the Sensitivity Switching switch.

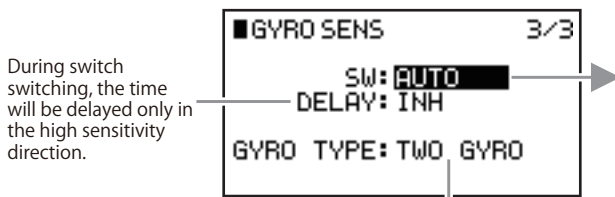

During switch switching, the time will be delayed only in the high sensitivity direction.

If "GYRO" is set to two output channels in the Device Select screen, this screen will be displayed. It will be possible to select twin gyros or dual gain.

● Select the Sensitivity Switching Switch.



If AUTO is selected, the sensitivity switching setting for each Flight Mode will be applied. Further, by operating the switch that you wish to use, input will be automatically carried out.

2 Set the sensitivity and Gyro Mode for each switch.

In the displays in this function, selection of the Flight Mode switches using the Device Select screen and Extension switch setting can be carried out. Further, if the Throttle Hold is not set to "ACT", the switches will not all be displayed. In addition, the displayed names will also be different for each model type.

Corresponding Switch Display (Flashing)

Helicopter Screen

CH: GEAR

T. LOCK

TRIM IN

INH

TRIM INPUT SW

TIS2

TIS3

TIS1

Airplane Screen

FM-0: 50%

FM-1: 50%

FM-2: 50%

The type of Trim Input switch can be selected.

### Hints

- There are three types of gyros as shown in the figure at right. Carefully read the gyro operation manual and set the type of gyro.
- By using the Trim Input, because it will be possible to change the gyro sensitivity value using the trim lever, the sensitivity can be easily adjusted even when the aircraft is flying.

### Caution Items

- Please carefully read and fully understand the manual of the gyro that is being used in advance before using the gyro.
- Be certain to move the tail around to confirm the gyro output direction before flying.

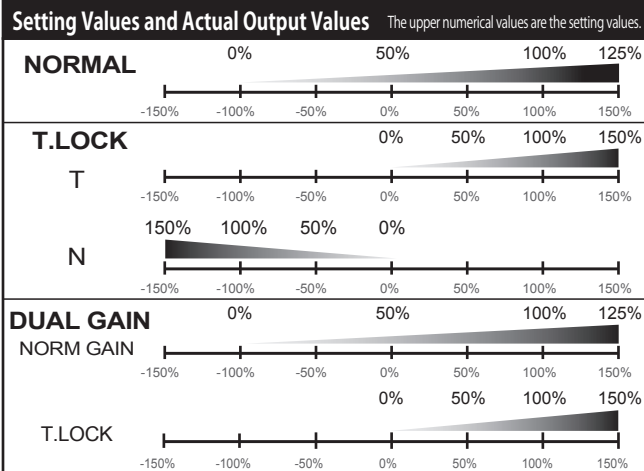



# GOVERNOR [GOVERNOR]

## Function Explanation

- This function maintains the rotor rotation speed at a uniform value, and sets the rotation speed of the Governor that aids stable flight. This will allow settings to be made separately for each Flight Mode. If the output "OUT" of on auxiliary channel is not set to "GOV" before using the function, the display in the Function List will be shown as non-usable. In addition, the Trim Input switch function can also be used.

## Setting Method

- On the screen, set the rotor rotation speeds for each Flight Mode. Select the desired Flight Mode by rotating the dial, then press the dial to display the box for numerical value adjustment. Note that because the setting from the transmitter is a rate adjustment, the actual rotation speed should be set and confirmed at the governor side.

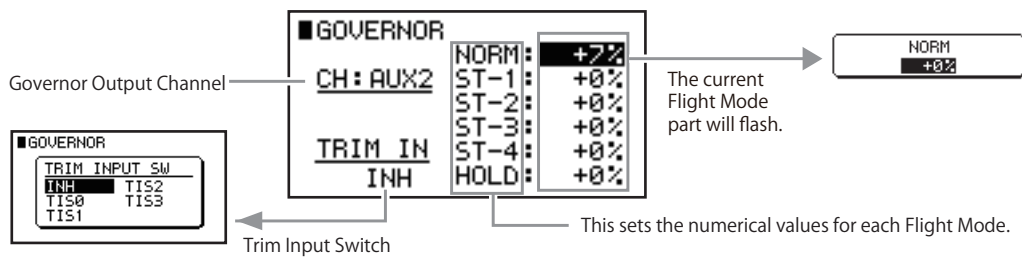

### Hint

- By using the Trim Input, it will be possible to change the gyro sensitivity values using the Trim Lever. Therefore, it will be possible to easily adjust the sensitivity even during flight.



# THROTTLE MIXING [MIX→THRO]

## Function Explanation

- By operating each control surface, the rotor rotation may be reduced due to loading. This function is a mixing function for implementing a correction for this effect. It will allow recreation of the rotation speed correction carried out automatically by the governor. It will also be possible to carry out setting using separate switches of the mixing from each of the control surfaces, comprising the ailerons, elevators, and rudder.

## Setting Method

- The screen covers two pages, and each of the correction mixing will be separately divided and displayed. For all of the mixes, it will be possible to switch ON/OFF using independent switches. After setting the switches, please confirm the display of the operation condition. Then set the correction amounts to the throttle using each of the stick operation directions. The stick should be set to whichever direction the rotor rotation increases when the operation is carried out.

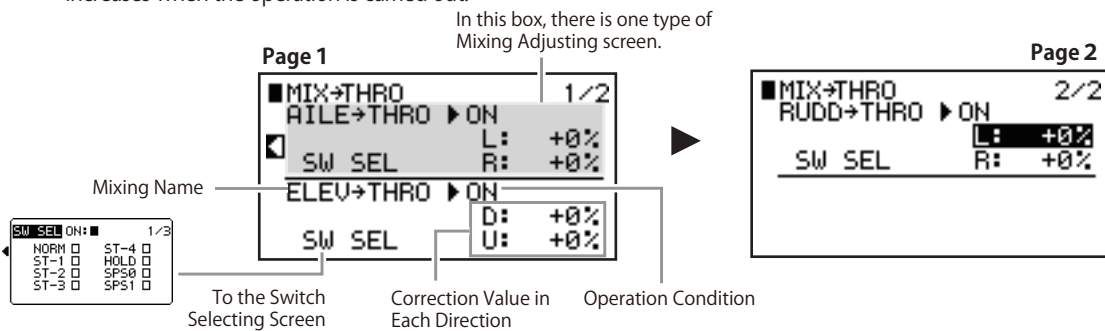

## Hints

- During numerical value setting, the CLR key can be used to reset the value.
- If the dial is rotated while pressing and holding the Function key, the numerical values can be changed at 10 times normal speed.
- As a rough guide to the setting values, it is recommended that the ailerons and elevators should be set to 10-30, and the rudder should start from L10/R15%.

## Caution Items

- ⚠ When using a governor, this function will not be required, and the numerical values should all be set to zero.
- Actually operate the servos and carefully confirm the settings before flying.



# THROTTLE TRIM [THRO TRIM]



## Function Explanation

- This function sets the Throttle Trim movement, and a Throttle Cut function is provided for cutting the engine. There is a Trim Memory function for cutting the engine using the Trim. Note that for airplanes, an Idle Adjust function is also incorporated that allows separate detailed setting of the idling position.

## Setting Method

- The Cut function can be used only with either the Throttle Cut or the Trim Memory. If the Throttle Cut is set to ACT, the Trim Memory will be forcibly set to INH. On the screen rotate the dial to move to and select the setting item (inverse display), then press the dial to set the item. Note that an Idling Adjust function that allows setting of Idle Up and Down for airplane models will be shown on Page 3.

### ● Throttle Cut Screen (Page 1)

If the function is set to ON and the stick is lowered, the carb will close and the servo will move to reach the set position.

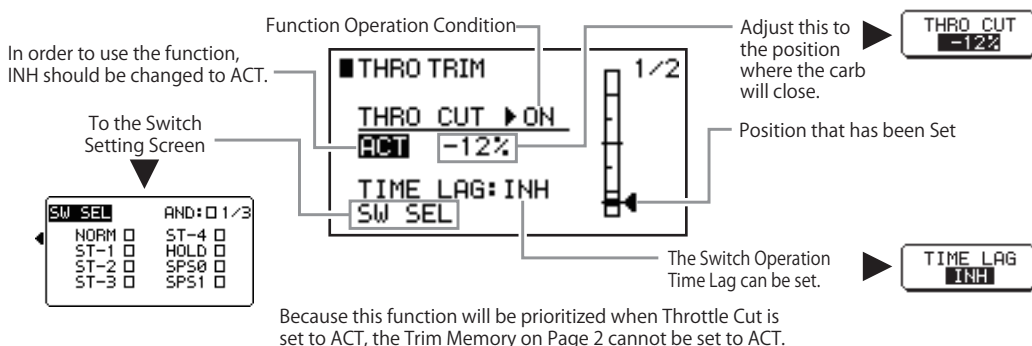

### ● Trim Memory Screen (Page 2)

When the Trim is lowered in a single action, the trim position immediately prior to the movement will be memorized, and when the trim is raised again, the trim will momentarily return to the memorized position. The memorized position will be marked on the Trim display.

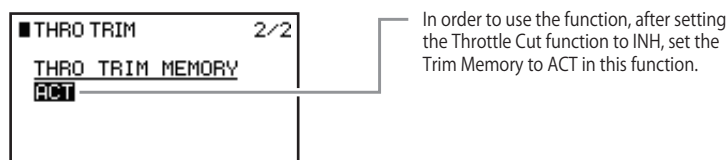

### ● Idling Adjustment Screen (Page 3)

The idling position during Stick Slow can be given separate detailed settings using the switches.

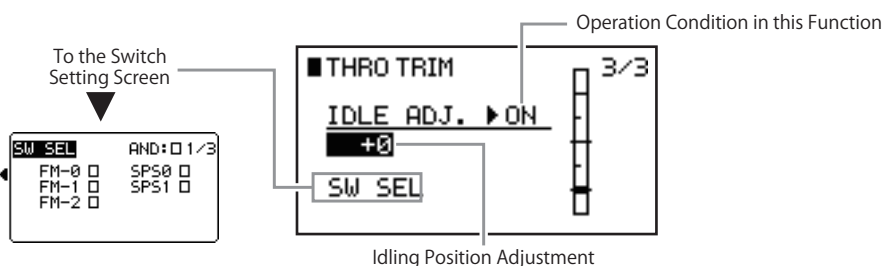

### Hints

- Please carefully confirm whether the linkage will lock when the carb is closed.
- The switch names on the Switch Selection screen will differ slightly according to the model type.

### Caution Item

- Throttle Cut will only be effective in the situation where the Flight Mode in a helicopter has been set to "NORMAL".



# THROTTLE HOLD [THRO HOLD]

## Function Explanation

- This is a function for autorotation landing that can fix the Throttle Servo at the position where the engine is cut. Using selected switches, the engine can be fixed at an optional slow position. Further, there is also a Stick Auto function that allows switching of the servo to the Hold position when the stick is lowered to an optional position.

## Setting Method

- First set the function to ACT. Then adjust the Throttle to the position where you wish Hold to be applied. The usage switch will be set to the Hold switch as standard. Further, if "STICK AUTO" is set, the servo will change to the Hold position when the stick has been lowered to this position. Additionally, it will also be possible to set a delay to prevent the sudden increase in engine rotations when the Hold switch has been set to OFF. Not only by looking at the screen, but viewing the actual servo operation will allow easy understanding.
  - When the switch has been set to ON, if the stick is lowered the servo will operate until the set position is reached.

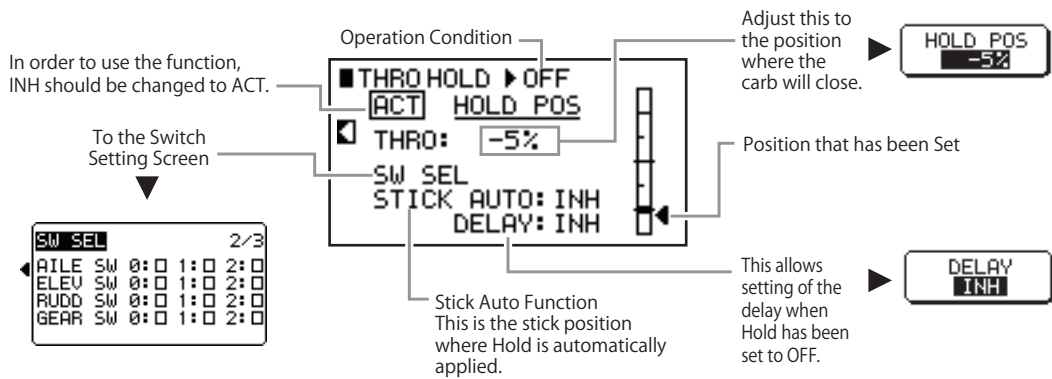

### Hints

- Using the CLR key, it will be possible to carry out reset to INH or the initial values.
- If the Hold Delay is set, the settings in the Servo Speed function will be cancelled.

### Caution Item

- ⚠ Actually operate the servos and carefully confirm the settings before flying.



# SWASH MIXING [SWASH MIX]

## Function Explanation

- This function sets the mixing relating to swash plates with the 1-4 servo units that control the movement of the main rotor. This swash mixing is for easily carrying out swash plate movement setting for helicopters that incorporate CCPM systems. CCPM is a type of pitch mixing in which the servos are directly linked to the swash plate so that the pitch is mechanically operated. In this transmitter, 6 types of swash plates can be selected. Matching the aircraft's swash plate specification, set the swash type setting using "SWASH TYPE" in the System List. An E-ring function is also incorporated that easily adjusts the swash maximum angle.

## Setting Method

- The setting items on the screen will be different according to the number of servos. This shows a setting example with three servos set at 120 degrees.

### ● Page 1 Screen

The control surface angle of each channel servo can be adjusted. Although the standard value is 60%, this should be re-adjusted according to the swash mechanism. EXP has an effect of reducing the error by approximating the horn's circular movement to a straight-line movement.

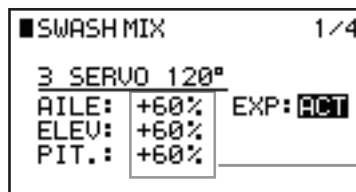

Servo Operation EXPO Setting

Each Servo Movement Amount

### ● Page 2 Screen

This corrects the tilt of the aileron side and elevator side when the pitch has been moved up and down. Adjustment of the mixing amount from the pitch to the ailerons and elevators can be carried out separately to the front and rear and to the left and right. The switching ON/OFF of the mixing on this screen can be set using the switches.

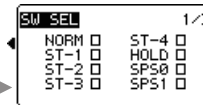

### ● Page 3 Screen

This is used for correction in the situation where the aileron and elevator operations mutually influence each other. The aileron and elevator mutual mixing amount can be separately adjusted. The switching ON/OFF of the mixing on this screen can be set using the switches.

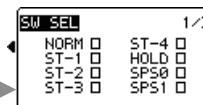

### ● Page 4 Screen

This is a convenient function that automatically corrects the swash electronically by the same angle in all directions. The operation of the stick can be confirmed on the graph. The diameter of the circle is the swash tilt angle, which can be set.

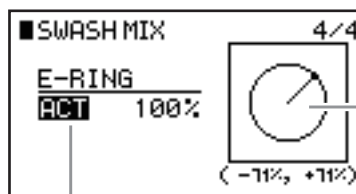

This is the E-ring. The diameter (angle) can be increased or decreased using the setting numerical value to the left.

In order to use this function, this item must be set to ACT.

## Hints

- The setting value in this function should be between 0 and 125. (The E-ring is 150.)
- The setting values can be reset using the CLR key.

### Caution Item

- ⚠ Actually operate the servos and carefully confirm the settings before flying.



## FLIGHT MODE DELAY [FM DELY]

### Function Explanation

- In the situation where the Flight Modes are switched, there may be cases where the servos may move suddenly, causing the flight movement to become jerky. To prevent this, it will be possible to set a time to each channel separately, during which the servo will move slowly to the servo position when switching the Flight Mode. This can be set separately in each Flight Mode.

### Setting Method

- Rotate the dial to select the desired channel in the setting screen, then press the dial to display the time setting box. The time displayed here will be the time for moving to the servo position of the Flight Mode that is currently being displayed.

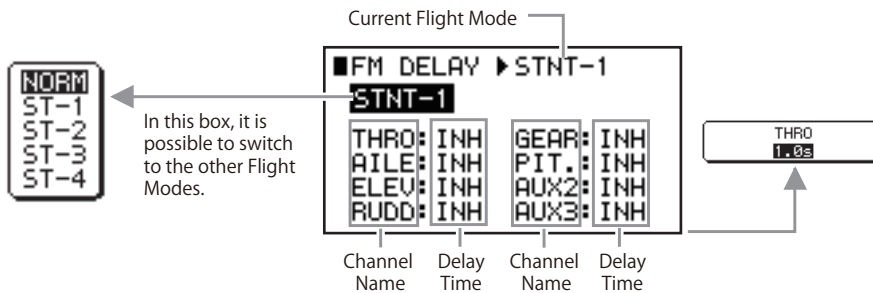

.....





# FLAP SYSTEM [FLAP SYS.]

## Function Explanation

- The flaps can be controlled in three stages using the switches. (Delay is possible.) Additionally, there is a function that carries out mixing to the elevators. There is also an Auto Throttle function that automatically lowers the flaps when the throttle stick is lowered. Further, aileron axis correction is also possible when the flaps have been greatly lowered while using the flaperons. In this screen, if the flap channel output has not been set to "SYS" in Device Select, the channels will be displayed as being unusable.

## Setting Method

This screen has three pages. Rotate the dial to select the items that can be set, then press the dial to display the setting box.

### Page 1

This carries out the flap settings and the setting of corrections to the elevators.

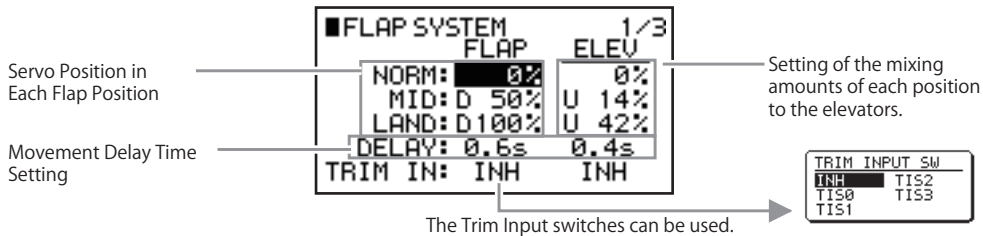

### Page 2

This carries out the correction setting to the ailerons.

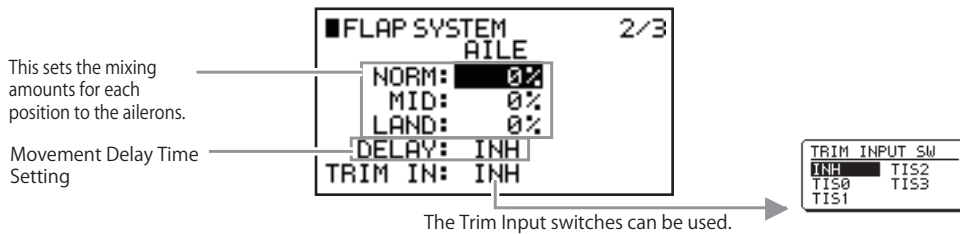

### Page 3

This carries out allocation to the Flight Mode and Auto Throttle setting.

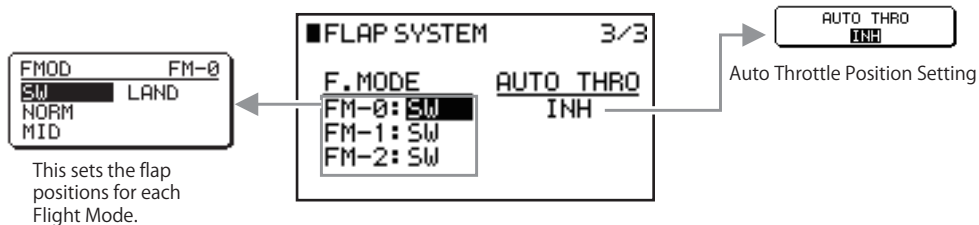

**Caution Item** ⚠ Actually operate the servos and carefully confirm the settings before flying.



# SNAP ROLL [SNAP ROLL]

## Function Explanation

- This is a function for easily carrying out Snap Rolls. There are four types of presets, and normally operation is carried out using the Snap switch. However, Stick switches are also incorporated that automatically enter a Snap Roll when the stick is operated by a fixed amount. Further, it is also possible to select in which Flight Modes the Snap switches will be effective.

## Setting Method

- First, release the INH setting and switch to the function screen. Rotate the dial to select the items, then press the dial to display the setting box. Initially, select the 4 types of presets. In the situation where the Stick switches are to be used, set the values for each control surface where the switches will switch ON. When stick operations exceeding these values are satisfied simultaneously, the Snap Roll will be implemented. In order to use the Snap switch, "SNAP SW" on Page 2 should be set to "ACT". In the situation where the Flight Mode switch has been set, this will be displayed at the right of the screen. If this is set to "ON", the Snap switch will be effective regardless of the Flight Mode. Set the Flight Modes in which the function will be effective.

### Page 1

	Initial Setting Values	AILE	ELEV	RUDD
S.ROLL0	LEFT-UP Left Up Snap Roll	L100%	U100%	L100%
S.ROLL1	LEFT-DOWN Left Down Snap Roll	L100%	D100%	R100%
S.ROLL2	RIGHT-UP Right Up Snap Roll	R100%	U100%	R100%
S.ROLL3	RIGHT-DOWN Right Down Snap Roll	R100%	D100%	L100%

Operation Condition This selects the presets.

ACT

GAIN STICK

AILE: L100% L 75

ELEV: U100% U 75

RUDD: L 75% L 70

This sets the conditions that set the Stick switches to ON. "INH" means that values have not been set.

This sets the positions of each control surface when movement has taken place.

### Page 2

Operation Condition

SNAP SW ACT

ON:

FM-0:

FM-1:

FM-2:

This will be displayed if the Flight Mode has been set. Set the positions in which the Snap switch will be effective. If ON is set, the switch will be effective in all positions.  means the switch is OFF, while  means the switch is ON.

To use the Snap switch, this should be set to "ACT".

- Caution Items** !
- Actually operate the servos and carefully confirm the settings before flying.
  - In the situation where the transmitter is being used as a trainer, this function will not operate.



# AILERONS → FLAPS [AILE→FLAP]

## Function Explanation

- This function mixes the aileron operation to the wing root flaps. This allows maneuvering using only ailerons to minimize the generation of air resistance when you wish to speed up the roll rate.

If Dual Flaps have not been set in the Wing Type screen on the System List, this screen will be displayed as being unable to use.

## Setting Method

The mixing amounts from the ailerons to the flaps can be set separately for the left and right. In addition, the switch for setting this function ON/OFF will be initially set to MIX-SW. In the situation where this is to be changed, this should be carried out using "SW SEL". It is also possible to set whether the Aileron Trim is to be included in the mixing. For all items, rotate the dial to select the item that can be set, then press the dial to display the setting box.

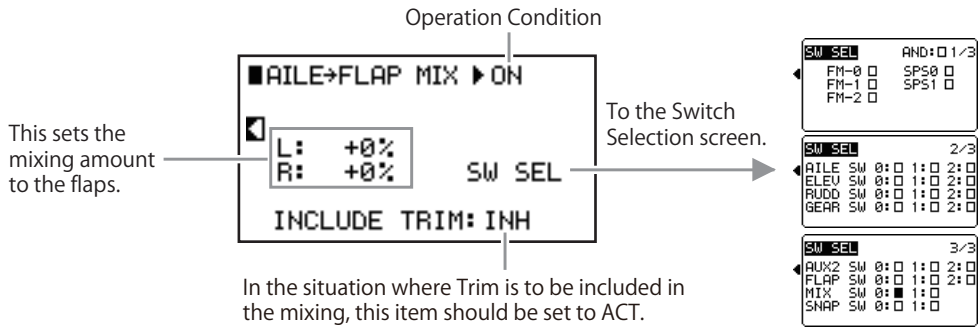

**Caution Items** ⚠️ Actually operate the servos and carefully confirm the settings before flying.



# ELEVATORS → FLAPS [ELEV→FLAP]

## Function Explanation

- This function mixes the elevator operation to the flaps as so-called air combat flaps (snap flaps).

## Setting Method

The mixing amounts from the elevators to the flaps can be set separately in the up and down directions. In addition, the switch for switching this function ON/OFF will be initially set to MIX-SW. In the situation where this is to be changed, this should be carried out using "SW SEL". For all items, rotate the dial to select the item that can be set, then press the dial to display the setting box.

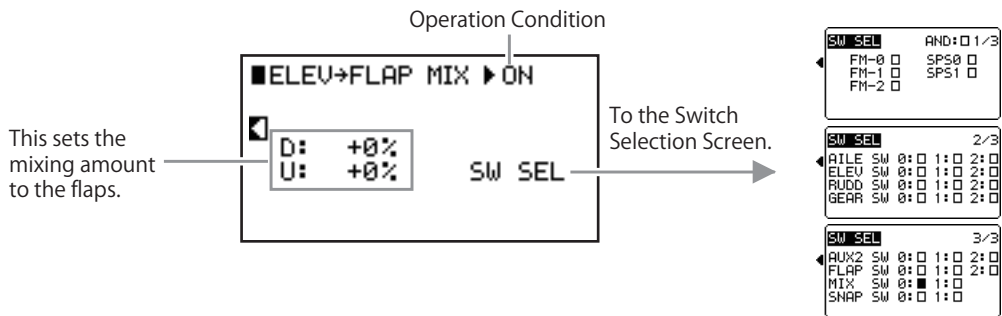

**Caution Items** ⚠️ Actually operate the servos and carefully confirm the settings before flying.



# RUDDER → AILERON/ELEVATOR [RUDD→A/E]

## Function Explanation

This function mixes the rudder operation to the ailerons and elevators. This is convenient for removing biases in knife-edge flying. In addition, a Trim Input switch that is convenient for making adjustments during flight can also be used.

## Setting Method

The mixing amounts from the rudder can be set separately in the up and down directions. In addition, the switch for switching this function ON/OFF will be initially set to MIX-SW. In the situation where this is to be changed, this should be carried out using "SW SEL". For all of the items, rotate the dial to select the item that can be set, then press the dial to display the setting box.

### ● Page 1

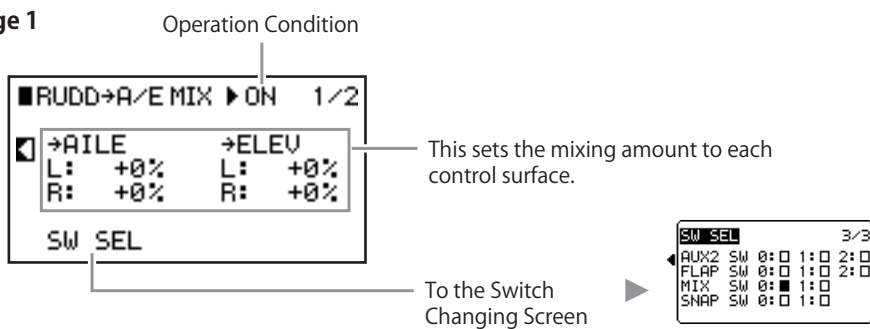

### ● Page 2

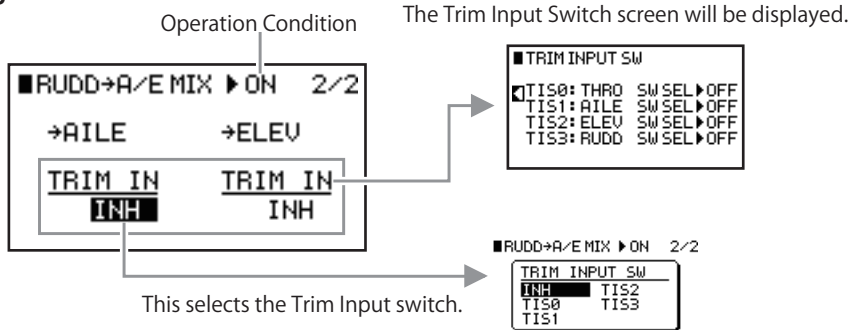

**Caution Items** ⚠️ Actually operate the servos and carefully confirm the settings before flying.



# AILERON → RUDDER MIXING [AILE→RUDD]



## Function Explanation

- This function allows smooth correction of turning for scale model aircraft. It will be possible to link the rudder operation using the aileron operation. In addition, in glider models a Brake function is also provided that automatically releases this mixing by rudder and elevator operation.

## Setting Method

- The left side of the display shows the current Flight Mode (only when settings have been made) and the left and right linked movement amounts. Rotate the dial to move to the item on the screen that can be set (inverse display) and select it. Then press the dial to display the setting box and carry out setting of the item.

### ● Screen for Airplanes

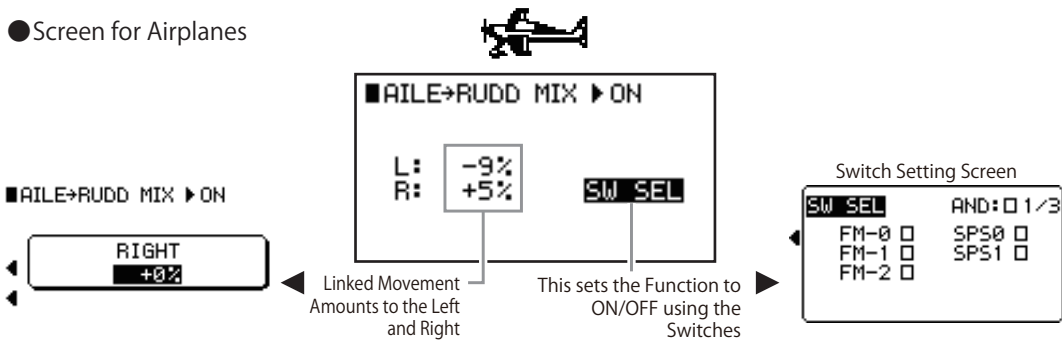

### ● Screen for Gliders (The screen also displays the current Flight Mode)

There are also Brake Point settings on the right side of the screen for releasing this mixing using stick operation.

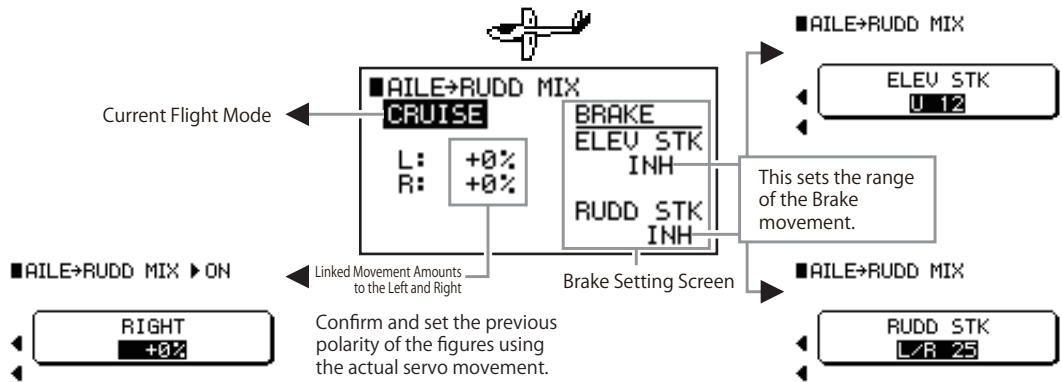

### Caution Items

- ⚠ Actually operate the servos and carefully confirm the settings before flying.

# Each Function in the Function List



## DIFFERENTIAL [DIFFEREN]



### Function Explanation

- This function can be used in the situation where the aileron, rudder, and flap channels have been set to Dual Channel settings (Servos are set to each control surface). Taking ailerons as an example, in the case where the wing type is a high-lift style, when the ailerons are moved up and down by the same angle, air resistance will be generated on the underside, causing the aircraft to yaw in the opposite direction to the intended turning direction. The function applies an action to the up and down movement angles to counter this effect. Further, in gliders there will also be situations during butterfly movements where the differential operation will not be necessary. To prepare for this, there is also a Brake function that cancels the differential when the Spoiler stick is lowered.

### Setting Method

- On the screen, only the control surfaces that have been set to Dual Channel will be displayed. Rotate the dial to move to the item on the screen that can be set (inverse display) and select it. Then press the dial to display the setting box and carry out setting of the item.

#### ● Screen for Airplanes (The screen displays the ailerons and flaps)



Channel Display and Differential Amounts

```

DIFFERENTIAL
AILE SW SEL ▶ ON
+0% TRIM IN: INH
FLAP SW SEL ▶ ON
+0% TRIM IN: INH
            
```

Confirm and set the previous polarity of the figures using the actual servo movement.

Operation Condition using the Ailerons

 NORM 0%

 DIFF 50%

 SPLIT 100%

Switch Setting Screen

```

SW SEL AND: 0 1/3
FM-0  SPS0
FM-1  SPS1
FM-2
            
```

```

DIFFERENTIAL
TRIM INPUT SW
INH TIS2
TIS0 TIS3
TIS1
            
```

```

TRIM INPUT SW
TIS0: THRO SW SEL ▶ OFF
TIS1: AILE SW SEL ▶ OFF
TIS2: ELEV SW SEL ▶ OFF
TIS3: RUDD SW SEL ▶ OFF
            
```

The ON/OFF of the function can be set using the switches.

The Trim Input switch can be selected.

This moves to the Trim Input Switch Setting screen.

#### ● Screen for Gliders (The screen displays the ailerons, V-tail, and flaps)



```

DIFFERENTIAL
CRUISE
AILE: +4%
RUDD: -3%
FLAP: +14%
BREAK: 10%
            
```

Current Flight Mode

Differential Amount

```

DIFFERENTIAL
AILE
+0%
            
```

According to the Spoiler Stick position, the set amounts will apply the brake. The stick upper limit will be the minimum (0%), while the lower limit will be the maximum (100%).

### Hints

- In the Glider type, it will not be possible to select switches or use the Trim In function.
- The setting values can be reset using the CLR key.

### Caution Items

- Actually operate the servos and carefully confirm the settings before flying.

## Each Function in the Function List



# LIMIT ADJUST [LIMIT ADJ.]

## Function Explanation

- When multiple mixing is used, the servo movement angle will become over-large and an unreasonable force will be applied to the linkages.  
If limit values are set to the angles, it will be possible to limit the movement of the servos above these values.

## Setting Method

- Set the limit values separately in the left/right/up/down directions for each channel (servo).

Page 1

This selects the Channel

Left/Right/Up/Down Limit Amounts

▼

▼

ページ 2

Left/Right/Up/Down Limit Amounts

Dial

Select the channel using the dial, and press the dial to display the adjusting box.

THRO  
H100%  
L100%

### Caution Item

- ⚠ Actually operate the servos and carefully confirm that the linkages do not lock.





## FLAP RATE [FLAP RATE]

### Function Explanation

- This function sets the up and down movement of the flap control surface angles in each Flight Mode using the Flap Lever operation.

### Setting Method

- On the screen, set the up and down control surface angles in each Flight Mode. Rotate the dial to select the setting items, then press the dial to display the adjusting box and carry out the settings. In the situation of gliders, the flap lever initial setting will be the lever on the right shoulder of the transmitter. In the situation where you wish to change this lever, change it using Device Select.

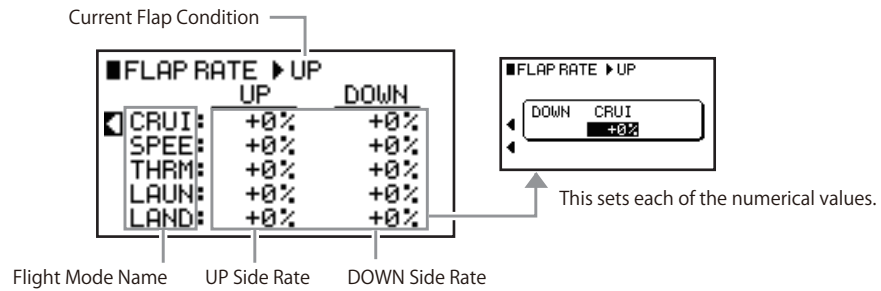

### Hint

- In the situation of using a competition aircraft where there is concern regarding mis-operation of the Flap Operation switches or levers, set the outputs to 0. Further, carry out the flap operation using other mixing (such as the Camber System).



# MOTOR SYSTEM [MOTO SYS.]

## Function Explanation

- This function controls the Speed Controller using switches. Using the Delay function, it will be possible to implement settings that move slowly as though made by stick operation. If "MOTO" has not been selected in OUT using Device Select in the System List, this function will be displayed as being unusable.

## Setting Method

- First select the SW that is to be operated using "SW SEL". Next, "HOLD POS" will show the position when the operation condition displayed on the screen is ON. This should normally be set to the pulse position where the Speed Controller starts braking. The pulse position when the operation is OFF will depend on the position of the operation input switch set in Device Select.

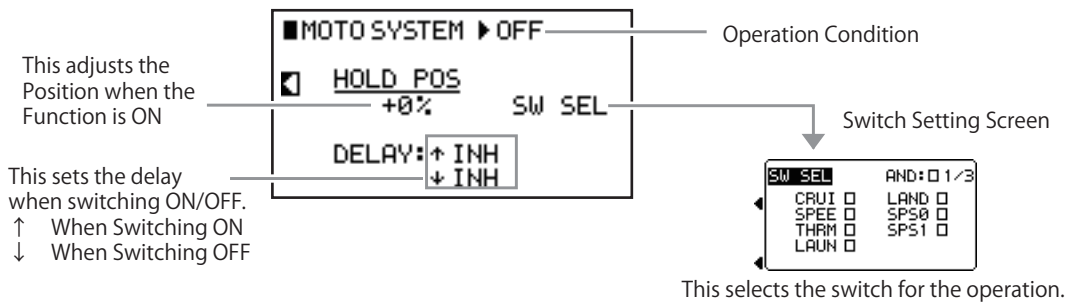

### Warning

When using this function, be certain to select the switch for controlling the motor using "SW SEL" in the Warning screen of the System List. Unlike the Throttle Stick, motor control carried out using switches will be easily overlooked, which will be very dangerous.

### Caution Item

- Actually operate the Speed Controller and carefully confirm the settings before flying.



# CAMBER SYSTEM [CAMBER SYS.]

## Function Explanation

- In the situation of aircraft which have full aileron or flap + aileron main wings with full-span moveable control surfaces, these control surfaces can be moved up and down simultaneously to change the wing type. Because changing the wing type can vary the rate of descent and the drag, it will be possible to change the flight endurance and the gliding ratio. These settings can be set for each Flight Mode. In addition, because the delay time during the switching can also be adjusted, the aircraft will not react wildly. During this delay time, rapid cancellation will also be possible using the elevator stick.

## Setting Method

- Although they are not shown on the screen, the aileron and flap camber adjustments in each Flight Mode should be carried out using the **Flap Trim** [FLAP/RTRM] and **Flaperon Trim** [FPRN/LTRM] located below the transmitter LED. Each of these Trims can be operated up and down simultaneously for each control surface. Next, set the Delay Time and Brake function when the Flight Mode has been changed on the screen. Rotate the dial to select the setting item, then press the dial to display the adjusting box and then make the settings.

● Page 1

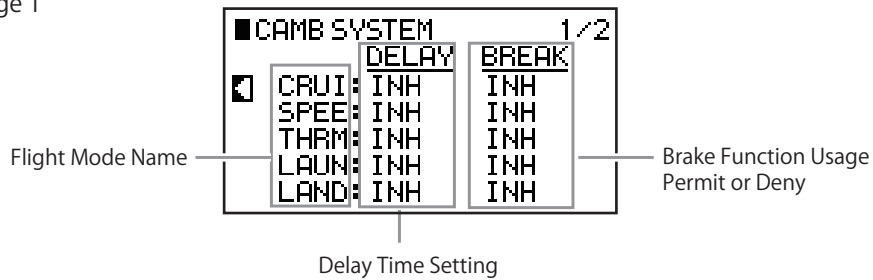

● Page 2

- This sets the range of the Brake movement using the Elevator Stick. Because the delay operation will be discontinued even if the stick exceeds the numerical values only momentarily, it will be possible to respond to sudden circumstances.

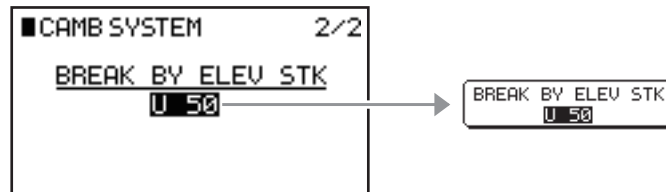

- If the Camber Position (Trim Position) that has been set in each of the Flight Modes is to be prevented from operating mistakenly, the method of setting this Trim to the operation invalid situation can be used to avoid operation. After setting the number of steps of the FLAP and FPRM Trim in the Trim System screen in the System List, these should be set to zero. By doing so, even though the Trim lever will not actually operate, the setting positions will remain memorized.



# BRAKE SYSTEM [BRAKE SYS.]

## Function Explanation

- This function recreates air brakes using the spoilers, ailerons, and flaps. The function is also known as Butterfly mixing and Crow mixing. When the spoiler stick is lowered, the flaps will lower and the ailerons will be lifted, so that looking from the front of the aircraft this will appear as air brakes. A blind band can be set to prevent mis-operation when operating the spoiler stick. In addition, the correction provided to the elevators can also be given detailed settings corresponding to the air brake angle using the curve points.

## Setting Method

- First set the mixing amount provided from the Spoiler Stick operation to the ailerons and flaps. Then adjust the Stick position where this mixing will be started.

● Page 1

This shows the movement angle when the spoilers are incorporated.

This adjusts the stick position where the brake operation will be started.

These are the movement angles to the ailerons and flaps.

- FPRN: Ailerons
- FLAP: Flaps

This selects the switch for switching ON/OFF the function.

SW SEL	3/3
AUX2 SW	0: 0 1: 0 2: 0
FWD SW	0: 0 1: 0 2: 0
BTFL SW	0: 0 1: 0
TRN SW	0: 0 1: 0

● Page 2

- This sets the correction mixing to the elevators.

Initially, curve setting points will not be set. To add points, set the stick to the position that you wish to add the point, and press the "ADD" key. In the situation of deleting this point, this should be carried out using the "DEL" key. The figure shows the situation where two points have been added.

Adjustment Point Display

Input Position and Output Position of Each Adjustment Point

Point Addition and Deletion

This changes the Point Connections to a Curve

Numerical Display of Stick Input Position and Output Position

● Page 3

- The Trim Input switch can be used.

Trim Input Switch Setting Screen

Trim Input Switch Selection

Points that can be adjusted using the Trim Input on the multi-curve screen are shown by circles.



- When this function is fully operated, the servos will move by a considerable amount. At this time, care will be required to avoid applying an unreasonable force to each of the control surfaces. Use the Limit Adjust function to apply limits to the servo movements to avoid damaging the control surfaces.
- After making the settings, operate the servos and carefully confirm each of the Flight Mode settings before flying.



# FLAPERON MIXING [FLAPERON M]

## Function Explanation

- This function is effective for model types with main wings that have variable control surfaces over the full span using ailerons + flaps. The aileron movement and flap movement amounts can be adjusted. Further, the changes in pitch caused by the flap movement can be corrected using the elevators. Additionally, this function allows settings to be made in each Flight Mode.

## Setting Method

- First, because the setting values of the Flap movement in the Flap Rate screen are taken as the standard, it will be necessary to carry out rate setting in advance. Set the flap movement operation to the lever or switch selected as the input device in the Device Select screen.

● Page 1

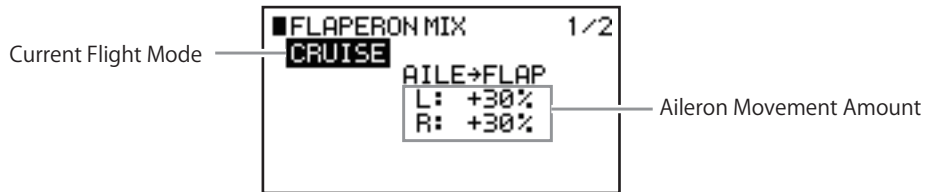

● Page 2

In the situation where the flap operation is being carried out using a lever, it will be possible to offset the mixing reference point.

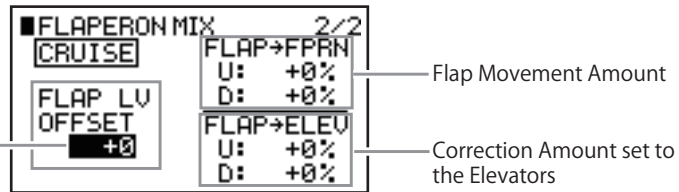

**Hint**

- In the situation where the flap operation is only on the down side, the flap operation will become easier if the offset position is aligned with the end of the flap lever. If the mixing reference point is set to zero on the U side of the flap movement amount in this screen, it will become easy to find using servo operation.



## ELEVATOR → CAMBER MIXING

[ELEV→CAMB]

### Function Explanation

- This function applies mixing to the main wing camber (wing type) from the elevator operation. Adjustment of the wing root flaps and wing tip flaperons separately in the up and down directions is possible. This function can be set for each Flight Mode.

### Setting Method

- Adjustment of the direction and amount with regard to the flaps and flaperons from the elevator operation is possible. Rotate the dial to select each item, then press the dial to display the setting screen and set the amount and direction. Note that the current Flight Mode is displayed at the top left of the screen. Additionally by utilizing the offset, the reference point where the mixing starts can be moved.

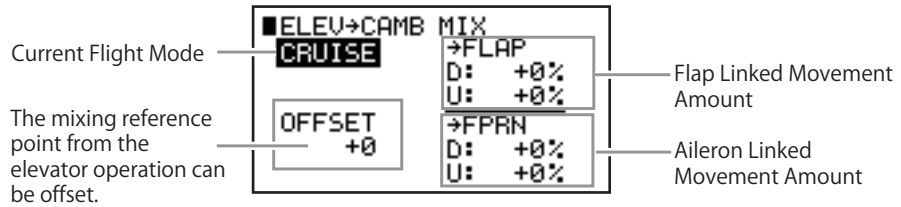

### Hint

- The so-called air combat flaps (snap flaps) can be used in aircraft with main wings that have 3-servo (channel) structures. To realize stability, reducing the mixing amount of the wing tip ailerons rather than the wing root flaps will cause an effect that reduces wing twisting and achieves stability.



## RUDDER → SPOILER MIXING [RUDD→SPOI]

### Function Explanation

- This function carries out rudder operation using the spoilers when the aircraft is provided with dual spoilers. This operation method is also known as drag rudder. According to the rudder operation, the left and right spoilers alternately operate. Because this function will be displayed as being unusable in the Function List, before use implement the Dual Spoiler setting in the Wing Type screen of the System List.

### Setting Method

- The Spoiler movement amount can be adjusted using the screen Gain value. This can be set separately in each Flight Mode.

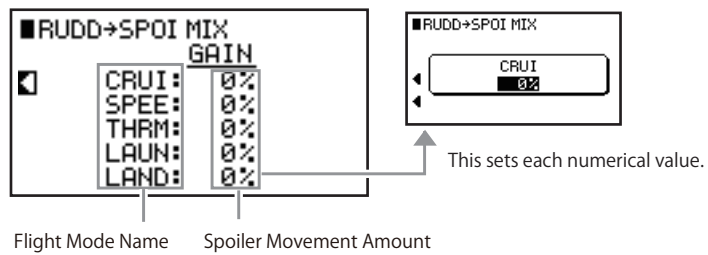

### Hint

- In the situation of a large-sized aircraft that is provided with spoilers on its main wing, if the spoilers are jointly used with the rudder it will be effective for yaw axis operation.



# PROGRAM MIXING 1-6 [PROG.MIX1~6]

## Function Explanation

- In the situation where a mixing movement is required that is not incorporated in the transmitter, six program mixing systems are provided for use. In the case where mixing is desired that is not provided in the transmitter, the mixing can be freely structured. For this mixing, either simple normal mixing or curve mixing that allows setting of a curve using multiple points can be selected.

## Setting Method

- Because this will be initially set to INH, select Normal mixing or Curve mixing.

### Normal Mixing Screen Page 1 Example of an Airplane

First, select the Master Channel for inputting the mixing, and the Slave Channel to which the mixing will be applied. For both, the types that can be selected will be different depending on the model. Then separately set the mixing amount in each direction. For this mixing, the setting can memorize two positions. By setting a switch, switching between these positions can be carried out.

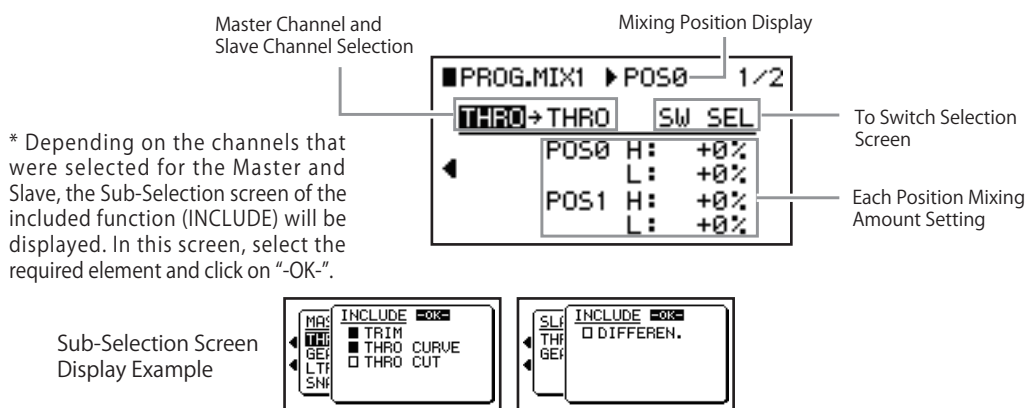

### Normal Mixing Screen Page 2

The mixing reference point can be offset from the Master Channel. The reason is to allow movement of the branching point of the Page 1 left/right (up/down) direction. Further, switching using the throttle stick position will also be possible.

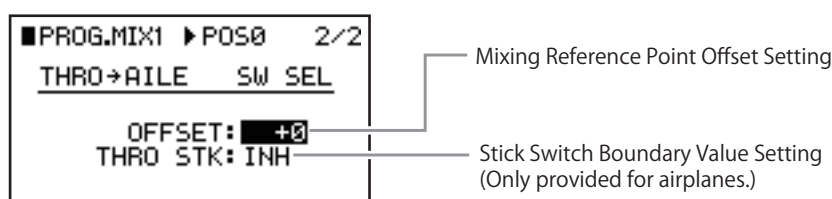

### Hints

- Each of the Master and Slave channel name display and switch names of the Switch Selection screen will be different for each model type.
- If the CLR key is pressed when the Master or Slave channel is shown in inverse display, this function will return to INH and the setting will be cleared.
- In helicopters, the function will be switched ON and OFF, rather than having two positions. Because the specification will carry out ON/OFF using the selected switch, the screen display will be different.

**Caution Item** Actually operate the servos and carefully confirm the settings before flying.





# PROGRAM MIXING 1-6 (Continued) [PROG.MIX1~6]

## Setting Method

### ● Curve Mixing Screen Page 1 Example of an Airplane

First, select the Master Channel for inputting the mixing, and the Slave Channel to which the mixing will be applied. For both, the types that can be selected will be different depending on the model and the settings. In addition, depending on the master and slave channel selection, the Sub-Selection screen that sets whether the input or output will be linked to each function will also be displayed. For this mixing, the setting can memorize two positions. By setting a switch, switching between these positions can be carried out.

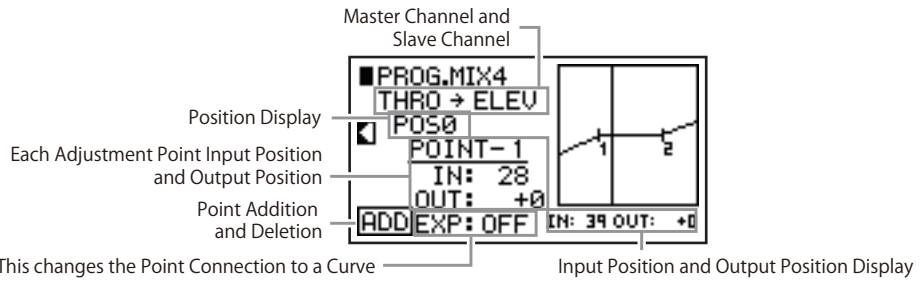

\* Depending on the channels that were selected for the Master and Slave, the Sub-Selection screen of the included function (INCLUDE) will be displayed. In this screen, select the required element and click on "-OK-".

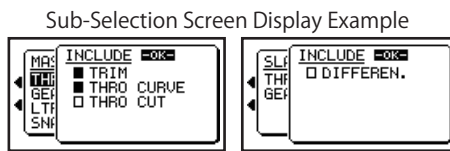

### ● Normal Mixing Screen Page 2

This carries out selection of the switch for switching between the two positions. In addition, switching using the Throttle Stick position will also be possible.

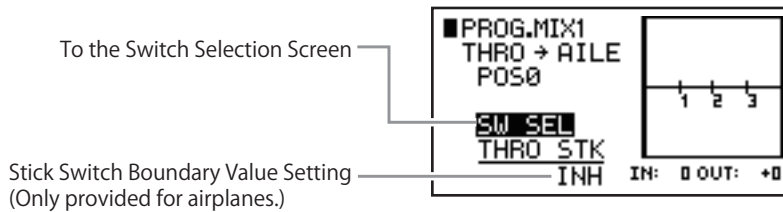

- Each of the Master and Slave channel name display and switch names of the Switch Selection screen will be different for each model type.
- If the CLR key is pressed when the Master or Slave channel is shown in inverse display, this function will return to INH and the setting will be cleared.
- In helicopters, the function will be switched ON and OFF, rather than having two positions. Because the specification will carry out ON/OFF using the selected switch, the screen display will be different.

#### Caution Item

- ❗ Actually operate the servos and carefully confirm the settings before flying.



# TIMER [TIMER]

## Function Explanation

- This transmitter incorporates two Timers and an Integrated Timer which counts up the transmitter power ON time. The Timer can be selected from an Up Timer and a Down Timer. Each can be operated in Flight Modes and through free switch selection.

## Setting Method

- Initially, because each of the Timers will be in the unset condition, select (INH) and press the dial to select the Timer type. Matching this, set the time and set the starting and stopping switches. Rotate the dial to move to the items that can be set (inverse display) on the screen to select the item. Then press the dial to display the setting box and carry out the setting.

● **Timer Screen** (The screen only shows the TIMER 1 setting)

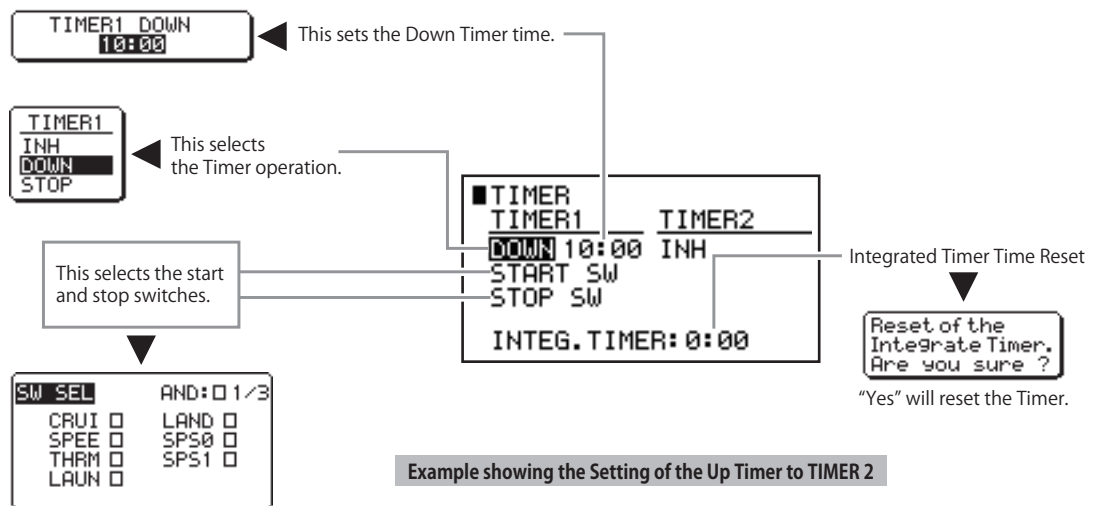

Example showing the Setting of the Up Timer to TIMER 2

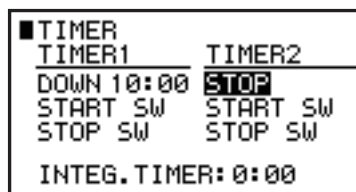

- The Down Timer can be set up to a maximum of 59 minutes 59 seconds. A signal will sound every 10 seconds for times of 1 minute or less, and every second for times of 10 seconds or less. From zero, the timer will start counting up in the "+" display.
- In the Up Timer (Stopwatch), a signal will sound every minute.

## Hints

- The setting values will be reset to their initial values using the CLR key.
- This screen can be entered from the Timer display of the Initial INFO screen.
- The switch names on the Switch Selection screen will differ slightly depending on the model type.
- While the Timer part of the Initial INFO screen is being selected, the CLR key can be used to reset the values.



# MIXING MONITOR [MIX MONIT.]



## Function Explanation

- This screen allows listing and confirmation of each of the mixing conditions and basic settings incorporated in the transmitter. Because all the mixing that has been incorporated in each model will be displayed regardless of whether it is set to INH or ACT, it will also be possible to discover unintentional setting mistakes. Further, since each of the items displayed on the screen will change directly to their function screens, it will be possible to avoid the trouble of searching for functions, allowing the speedy changing of settings. When users become used to the function, this will be a very convenient confirmation screen.

## Operation Method

- On the screen, the current condition of the Flight Modes and each setting switch will be displayed to allow confirmation. The names of each mixing function on the screen can be changed to inverse display by rotating the dial, and by then pressing the dial it will be possible to move directly to the corresponding function screen. Note that because the functions will also be different according to the model type, the displayed items will be different.

● Screen for Helicopters

● Screen for Airplanes

● Screen for Gliders

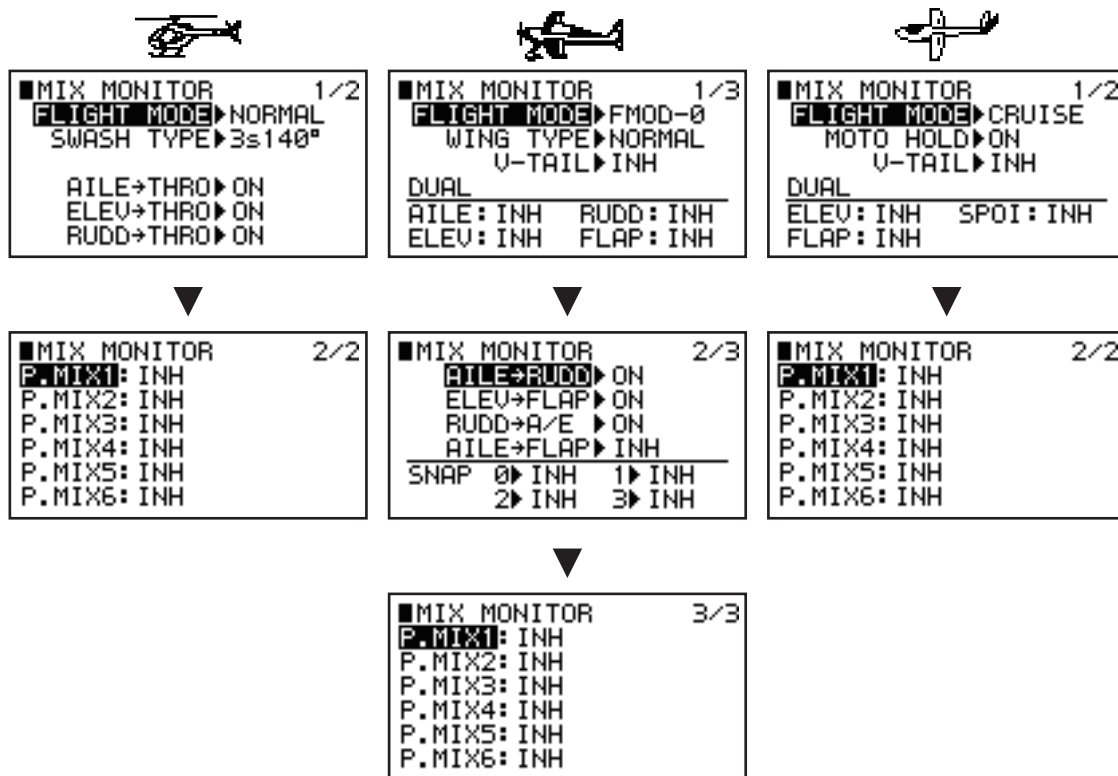

### Caution Item

- ! Actually operate the servos to confirm the Setting function before flying.



# SERVO MONITOR [MONITOR]



## Function Explanation

- This function allows simulation of the servo operations on the transmitter. Because all of the transmitter settings will be influenced, provisional confirmation can be carried out before actually connecting the servos. Further, this will also be useful for discovering unintentional mixing setting and switch setting mistakes.

## Setting Method

- Servo testing items will be displayed on the screen. If these items are clicked, the Auto Servo Testing screen will open and the testing items can be selected.

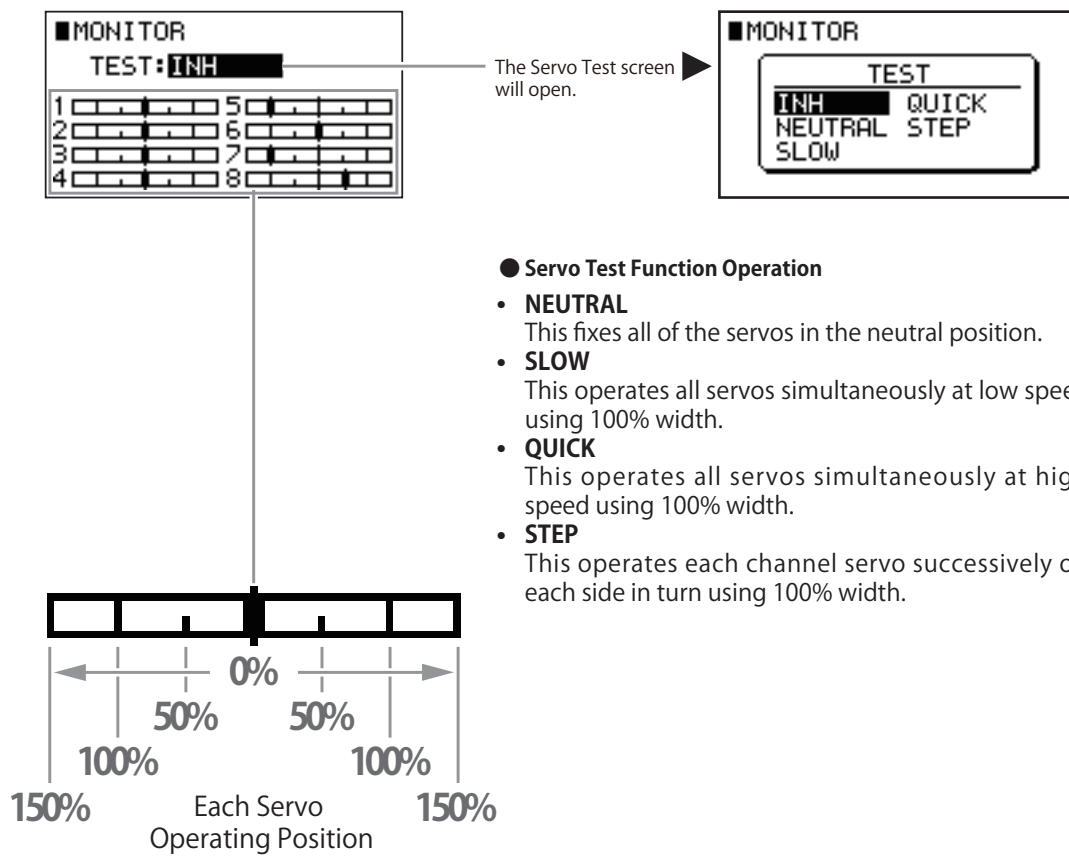

### ● Servo Test Function Operation

- **NEUTRAL**  
This fixes all of the servos in the neutral position.
- **SLOW**  
This operates all servos simultaneously at low speed using 100% width.
- **QUICK**  
This operates all servos simultaneously at high speed using 100% width.
- **STEP**  
This operates each channel servo successively on each side in turn using 100% width.

### Caution Items

- ! • Even when confirmation is carried out on the screen, be certain to confirm the servo operation before flying.
- In the situation where the servos incorporated in the aircraft are tested, because the servos will operate to their 100% position, take care that the linkages do not lock.

## Each Function in the System List



# MODEL SELECT [MODEL SEL]



## Function Explanation

- In this screen, the establishing of new models and switching between models is carried out. For the model memories, up to 30 units can be freely registered as model types.



## Setting Method

- For safety reasons, a screen that initially stops the issuing of the radio waves will be displayed, so select "YES" to change the screen to this function screen. Next, the current Model No. and Model Name will be displayed, so select the item and press the dial. Then match the model that you wish to switch to and press the dial to select it. When creating a new model, selecting the "----" part will start up the Setting Navigation to allow new model creation to be carried out.

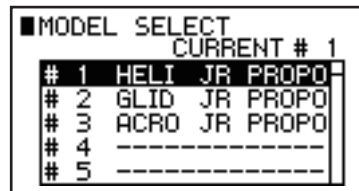
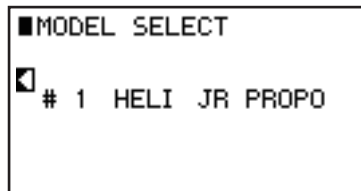

For safety reasons, receivers that had binding carried out will not operate after the models have been changed using the transmitter. Carry out the binding again.

## Each Function in the System List



# MODEL COPY & ERASE [COPY/ERASE]

## Function Explanation

- In this screen, copying and erasing of model data is carried out. This can be implemented in the transmitter memory and on an SD Card. In addition, it will even be possible to copy model data between XG8 transmitters that have been connected using a trainer cable.

## Setting Method

- For safety reasons, a screen that initially stops the issuing of the radio waves will be displayed, so select "YES" to change the screen to the function screen. First, select either Copy or Erase at the top right of the screen. Following this, the work flow will consist of selecting the copy source and copy destination and implementing the Copy function.

### ● Copy/Erase Screen [COPY], [ERASE]

Select the Copy Source and Copy Destination. "INTERNAL" will be displayed for the transmitter main unit, "SD CARD" will be displayed for the transmitter SD Card, and "TRANSFER" will be displayed for an external transmitter. Then select the Model using the lower stage of the location display.

Implementation is carried out using the FUNCTION key shown at the bottom left of the screen. During the copying process, the display will be cleared. Do not press any of the keys and wait until the "ALL OK" message is displayed.

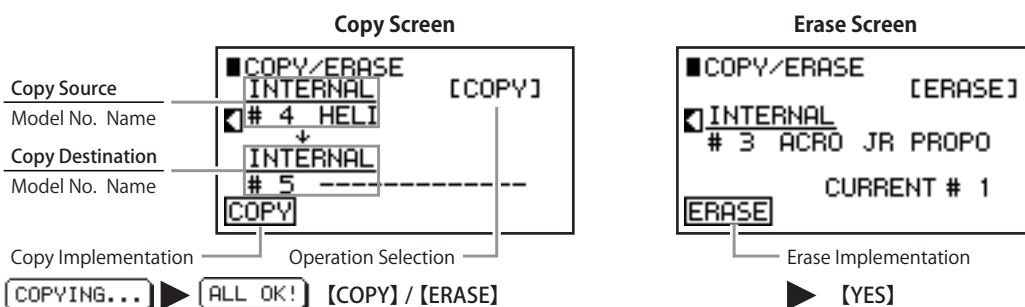

### ● Screen for Data Transfer to an External XG8 Unit

When connecting the transmitter to an external XG8, set the power switches of both transmitters to OFF before connecting the trainer cable. The power will switch ON automatically. Following this, set each of the transmitter screens to the condition shown below, then carry out the transfer by pressing the FUNCTION key of the copy source transmitter. In the situation where there is a problem with the cable connection, an error will be displayed.

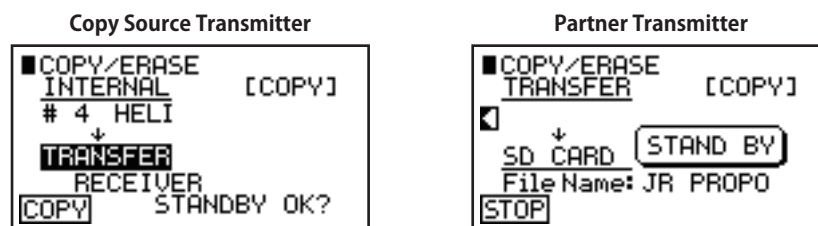

### Hints

- When a newly copied model is to be used, it will be necessary to carry out the binding with the receiver again.
- In the situation where the model is copied inside the transmitter, it will not be possible to overwrite the data on top of an existing model. Either erase the existing model or carry out copying to an empty memory.
- In the case where you erase the model that is currently being used, the Setting Navigation will be automatically started up.
- In the situation where the copy is to be made to an SD Card, registration of the same name will not be possible. A Guide will be displayed, so input a different File name.

### Caution Items

- While this screen is being displayed, and during copy implementation, absolutely do not take out the SD Card under any circumstances. There will be a danger of destroying the Model Data.
- Actually operate the servos and carefully confirm the settings before flying.



# MODEL TYPE SELECT [TYPE SEL.]



## Function Explanation

- This function changes the model type that is currently set. The type can be switched between Helicopter ⇄ Airplane ⇄ Glider. Additionally, this screen will be automatically displayed when creating a new model.



## Setting Method

- In the situation of entering this function screen from the System List, the model type that is currently being used will be changed. Select the type that you wish to change to by rotating the dial, then press the dial to determine the type. After doing so, you will be asked whether the current model data is to be reset, so select "YES" to implement the reset.

### Page 1 Screen

Existing Model No. and Name

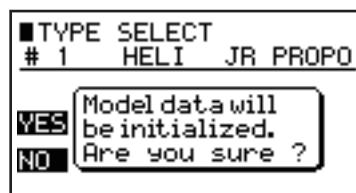

### Caution Item

- Because the previous data will be erased when the model type is changed, in the case of important data the data should be copied and backed-up beforehand.

.....

### Hint

- The connections with the receiver should be made as shown in the figure below.

Receiver	Helicopter	Airplane	Glider
THRO	THRO	THRO	LAILE
AILE	AILE	AILE	RAILE
ELEV	ELEV	ELEV	ELEV
RUDD	RUDD	RUDD	RUDD
GEAR	GEAR	GEAR	GEAR
AUX1	AUX1	FLAP	FLAP
AUX2	AUX2	AUX2	AUX2
AUX3	AUX3	AUX3	AUX3

## Each Function in the System List



### MODEL NAME [MODEL NAME]



#### Function Explanation

- In this screen, the registration and changing of each model's name can be carried out. Select the name from the list of characters and numbers



#### Setting Method

- The name of the model data that is currently being used can be registered and changed. First, move the **■** to the desired position, and press the dial. By doing this, the cursor will move to the list of characters, allowing you to select your desired characters and input them by pressing the dial. The LIST key enables you to return from character selection to the Name Input line. Because there is no Delete key, to correct an input you should return to the Name Input line and overwrite the name.

- After the input has been completed, press the "LIST" key ⇒ "ENTER" key in this order to determine the input.

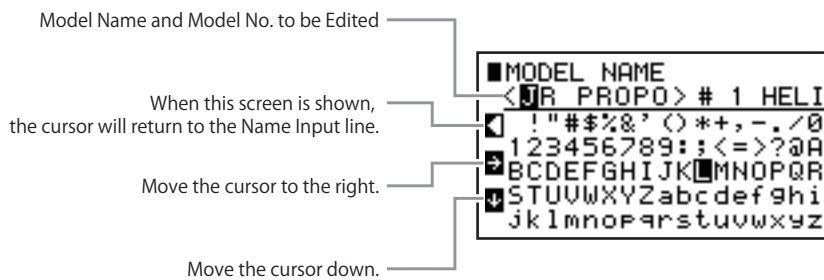



## Each Function in the System List



# FLIGHT MODE NAME [FM NAME]

## Function Explanation

- In this screen, the name of the Flight Mode can be changed. The Flight Mode name display is shown with two names, one long name and one short name, which are used in each of the screens, and each can be freely changed.

## Setting Method

- In each Flight Mode, there are displays of a long, 6-character name and a short 4-character name. Rotate the dial to select the name that you wish to change, then press the dial and carry out the inputting using the same editing screen that is used in the Editing screen. Here, the name should be changed while taking care of the number of characters. Note that for the method of operating the Editing screen, refer to the Model Name section.

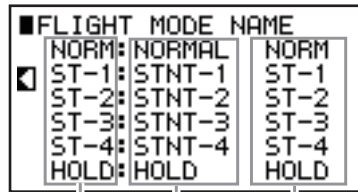

Flight Mode, Original Name ———— Short Name  
 ———— Long Name

.....

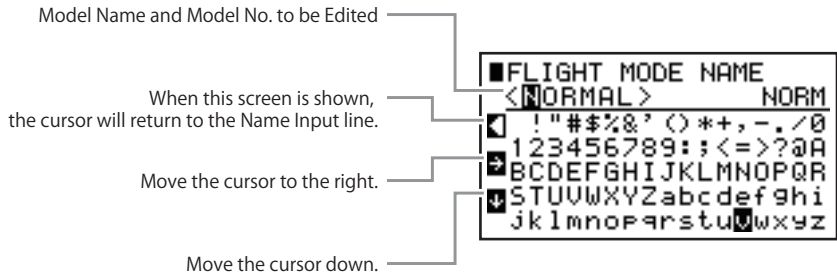

- After the input has been completed, press the "LIST" key ⇒ "ENTER" key in this order to determine the input.

## Each Function in the System List



# TRIM SYSTEM [TRIM SYS]

## Function Explanation

- In this screen, the various settings relating to Trim can be changed. The resolution of each Trim, the Trim type, the position replacement settings and whether separate use or common use is to be used in the Flight Mode can be set. Using this function, customers can freely change the settings of the easy-to-use Trim.

## Setting Method

- In Page 1, the Trim steps and Trim type for each channel can also be set. Rotate the dial to select the items, and push the dial to change the items. In Page 2, it is possible to set whether the Trim between Flight Modes is to be used separately or commonly, and to set Cross Trim (replacement) which makes it easy to carry out adjustment during flight. (Except for gliders)

### Screen for Helicopters



TRIM SYSTEM 1/2

THRO:	4	IDLE
AILE:	4	L.S.T.
ELEV:	4	L.S.T.
RUDD:	4	L.S.T.
HV. T:	4	
HV. P:	4	

TRIM SYSTEM 2/2

STUNT TRIM: COM

CROSS TRIM

THRO/HV. T: ACT SW SEL

ELEV/HV. P: ACT SW SEL

Channel Name

Trim Step Amount

Trim Type  
NORM: Normal Trim  
IDLE: Slow Side Trim  
L.S.T: Limit Stroke Trim

Type of Trim  
If INH is released, Trim replacement using the switches will become possible.

SU SEL ON: AND: 1/3

NORM	ST-4
ST-1	HOLD
ST-2	SP50
ST-3	SP51

Trim between Flight Modes  
COM: Common  
FMOD: Separate

### Screen for Airplanes



The channel names will change slightly according to the model type.

TRIM SYSTEM 1/2

THRO:	4	
AILE:	4	L.S.T.
ELEV:	4	L.S.T.
RUDD:	4	L.S.T.
FLAP:	4	L.S.T.
AUX:	4	

TRIM SYSTEM 2/2

FMOD TRIM: COM

FLAP TRIM: ON

CROSS TRIM

THRO/ELEV: OFF

FLAP/AUX: OFF

Trim between Flight Modes  
COM: Common  
FMOD: Separate

This switches ON/OFF the Flap Trim

Trim Position Replacement

Same as in the Helicopter Screen

### Screen for Gliders

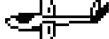

TRIM SYSTEM 1/2

SPOI:	4	
AILE:	4	L.S.T.
ELEV:	4	L.S.T.
RUDD:	4	L.S.T.
FLAP:	1	
FPRN:	1	

TRIM SYSTEM 2/2

AILE/RUDD TRIM: FMOD

FPRN DIRECTION: NORM

Trim between Flight Modes  
COM: Common  
FMOD: Separate

Flaperon Trim Movement Direction

Same as in the Helicopter Screen

### Hints

- L.S.T. is an abbreviation of Limit Stroke Trim. It differs from Normal Trim, which carries out movement over the complete servo movement range, since it is a Trim system that moves the trim greatly in the central part without moving the Trim at each end. For this reason, because the maximum control surface angle used for the Trim adjustment will not change, there need be no concern that the linkages will lock.
- In the case of helicopters, when "NORM" has been selected in the Throttle Trim the complete Throttle Curve can be moved up and down. This will be highly convenient in situations such as when using Gas mode in the motor amplifier setting of electrically powered helicopters.



# STICK POSITION SWITCH [STK POS SW]

## Function Explanation

- This is a convenient function that allows the switching ON/OFF of virtual switches using the stick operation. This means that it will be possible to freely switch ON/OFF the virtual switches at desired stick positions. Two of these virtual switch systems have been prepared that can be utilized in the switching of various types of functions. The switch names are "SPS0" and "SPS1".

## Setting Method

- The screen has a page for each switch type. Because the switches will initially be set to the "INH" condition, set the optional sticks. The switch ON/OFF condition can be confirmed from the operation monitor at the right of the screen. Each of the setting items can be set by rotating the dial to select them and then pressing the dial.

### Stick Position Screen

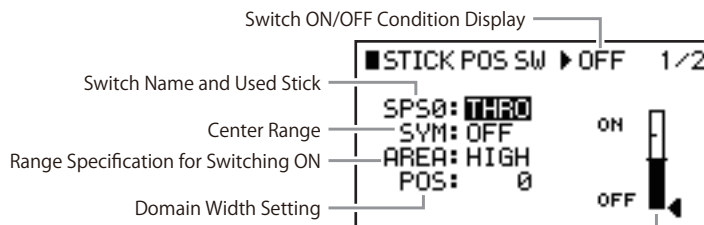

White is the ON range, and black is the OFF range. Depending on the switch that is used, the Monitor screen direction will change.

If SYM is set to ON, the range will appear in the neighborhood of the neutral position.

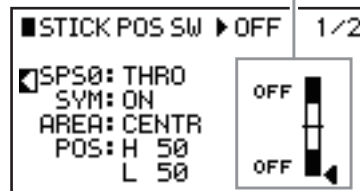

### Hint

- This function will be conveniently used for switching ON/OFF the mixing and for switching ON/OFF the timer.



# TRIM INPUT SWITCH [TRIM IN SW]

## Function Explanation

- Among each of the functions, there are some items that set numerical values. These must be set in each screen by selecting the adjusting location and carrying out the settings using the dial. This function allows adjustment of these numerical value settings using the desired trim. The function enables the creation of four systems, and for each it is possible to set which trim can be used for adjusting the values. In addition, the switching ON/OFF of this function can also be carried out using the Flight Mode switches or other switches. In this new function, the previous troublesome adjustments that were carried out using the dial while the Setting screen was being displayed have been eliminated, so that adjustment of the required functions can be easily carried out even during flight using the INFO screen and Telemetry screen. (Ex.: Gyro Sensing/Governor/Rudder→Aileron/Elevator Mixing, etc.)

## Setting Method

- The Trim Input switches have four types, from "TIS0" to "TIS3". For each Trim switch, select which Trim Lever will be used to operate it. Then select which switches are to be used to switch ON/OFF this Trim In function.

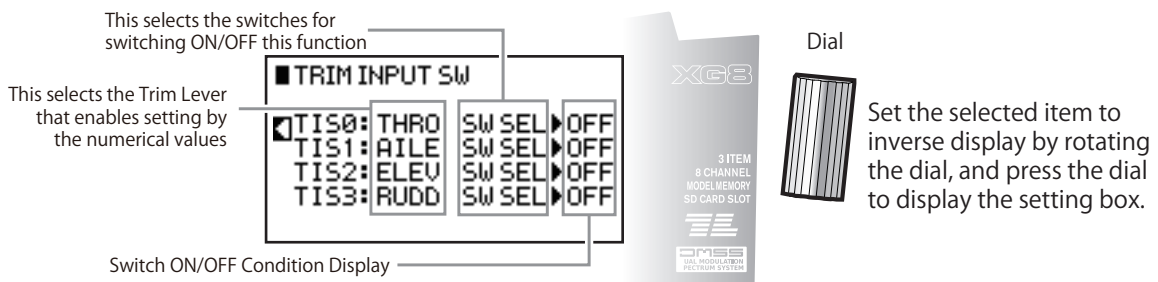

### ● Trim Levers that can be Selected

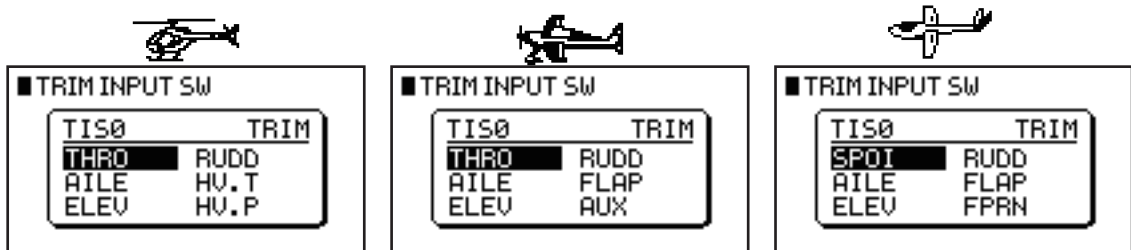

### ● Select the Switches that Switch ON/OFF the Function (There are 3 pages)

Click on each  mark to change it to  and set it to ON.  
If "AND" is clicked, only one location will be set to ON in each switch position.

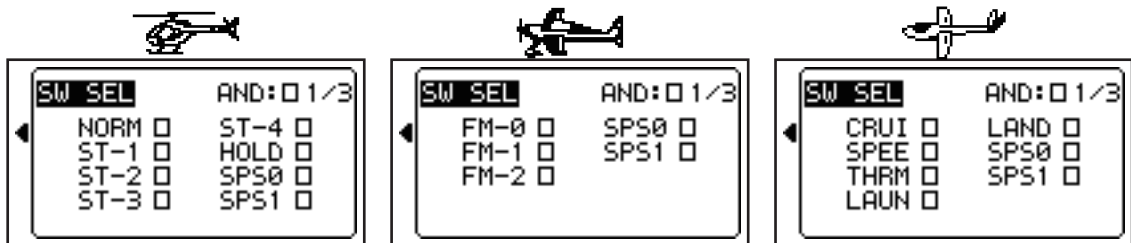

### Hint

- In the situation where there is a "TRIM IN" display in each function screen, it will also be possible to move to this Setting screen.

### Caution Items

- ⚠ Actually operate the servos and carefully confirm the settings before flying.

## Each Function in the System List



Helicopter



Airplane



Glider

# STICK ALERT [STK ALAERT]

## Function Explanation

- This function will sound an alert when the Throttle Stick reaches a certain position. It will be convenient because it will allow confirmation using sound of the hovering position or zero pitch position, and confirmation in the case where the Stick Position switch has been set to the Throttle. In addition, it will be possible to set the switching ON/OFF of the alert sound to your preferred switches.

## Setting Method

- First, because the initial setting is "INH", which inhibits usage, set this to "ACT". Adjust the stick position where the sound is to be output using "POS". In addition, the ON/OFF setting of this function can also be set using "SW SEL". Select the switch using the Switch Selection screen.

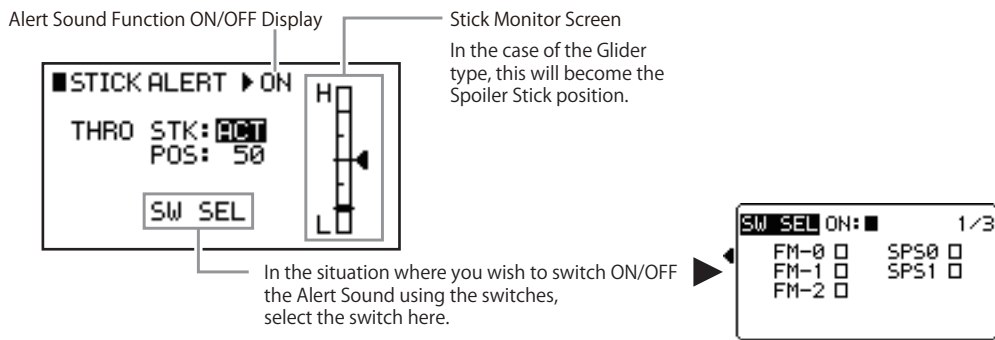

## Each Function in the System List



# WARNING [WARNING]

## Function Description

- In the situation where the Throttle Stick or Flight Mode switches are set to dangerous positions when the transmitter is switched on, there will be a danger of injuries being caused if the receiver is switched on in this condition. To prevent this from happening, a warning screen will be displayed and the radio waves will not be emitted until the transmitter stick and switches have been returned to safe positions. This is the screen used for setting these warning items.

## Setting Method

- First set "INH" to "ACT" to make the function effective. Then set the range settings and direction where the warning will be given using the Throttle Stick, and the switch and positions where the warning is to be set. Particularly for electrically powered gliders, do not forget to set the switch that operates the motor.

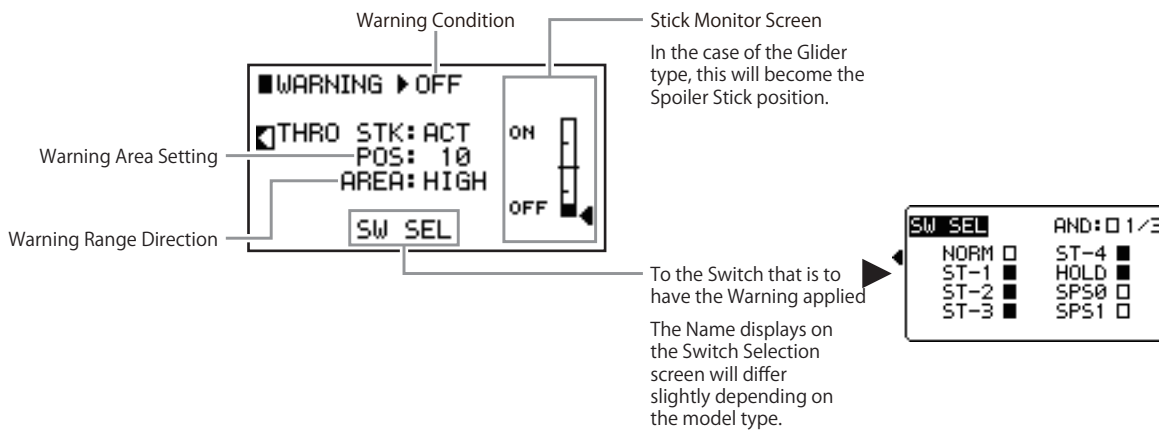

### ! Caution

For safety reasons, be certain to set this function and carry out confirmation of the warning when the transmitter switches are switched on.

## Each Function in the System List



# TRANSMITTER SETTINGS [TX SETTING]

## Function Explanation

- Setting can be carried out of the transmitter LCD screen and of each sound, the transmitter power source voltage alarm, the software version, and the Idle Alert warning when the transmitter is not operating. This last setting prevents against forgetting to switch off the transmitter power.

## Setting Method

- Rotate the dial to select the setting item on the screen, and press the dial to change the setting.

### ● Page 1

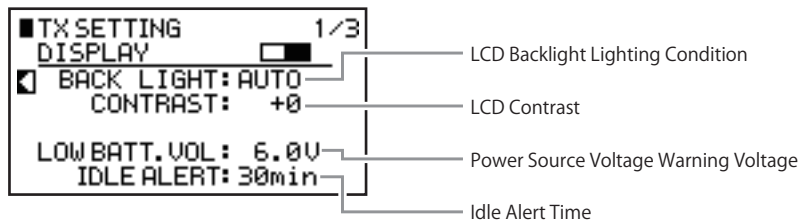

### ● Page 2

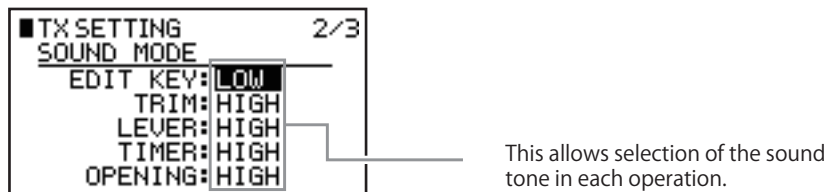

### ● Page 3

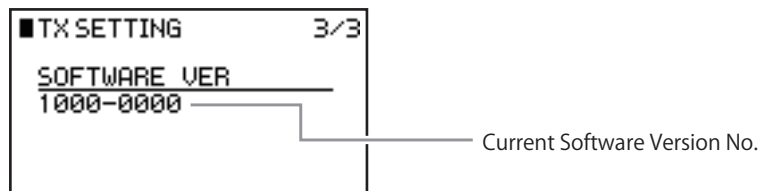



# TRAINER [TRAINER]



## Function Explanation

- This function allows guidance of the Slave stick operation on an identical XG8 transmitter or another transmitter manufactured by JR that is connected using the trainer cable. The operation switching is carried out using the trainer switches of the Master transmitter.



## Setting Method

- The settings should be carried out using the Master transmitter. Then determine using the Master transmitter which of the sticks are to be practiced on the slave transmitter. The Stick channels of the switch positions on the screen that have been moved to the "SLAVE" side can be operated using the Slave transmitter.  
(However, this will only be the case for slave transmitters that incorporate the Programmable Function Trainer function.)

### Master Side Screen

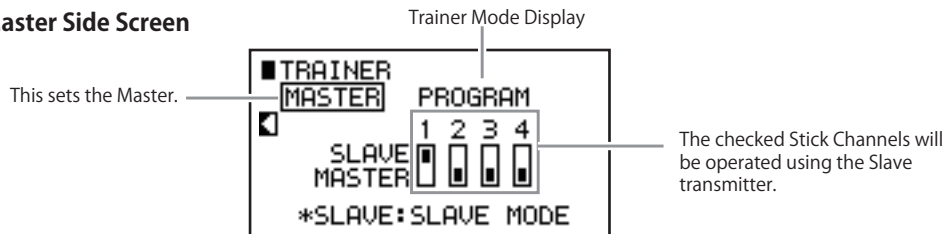

### Slave Side Screen

Connect the trainer cable when the power of the Slave transmitter (trainee) is in the OFF condition. In the situation where the Slave transmitter has an LCD screen, the Trainer Function screen will show "SLAVE". Further, carefully confirm the connection.

Screen during Normal Connection



Screen when there are Connection Problems



The cable is not connected or the power is switched on.

## Hint

- In the situation where the Slave transmitter does not incorporate the Programmable Function Trainer function, in principle the training can not be carried out unless the aircraft can be flown (the flight can be set) using the Slave transmitter. However, when the Slave transmitter supports the Programmable Function Trainer function, training will be possible for any aircraft provided it can be flown using the Master transmitter.

### Caution Item

- Before flying, be certain to match the same positions to ensure there is no displacement of the servos for each Stick Trim in the Master and Slave transmitters. Further, also confirm the directions and control surface angles.





## FAIL SAFE [FAIL SAFE]

### Function Explanation

This is a function that moves the servos to optional positions that were previously set in the situation where the receiver cannot normally receive the radio waves from the transmitter. As it will be particularly dangerous when the motive power is left running in an out-of-control situation, be certain to implement these settings.

### Setting Method

This function allows selections to be made for each channel in an out-of-control situation as "HOLD", which maintains the positions as they were immediately before the radio waves were lost, or as "FAIL SAFE" which switches to optional servo positions when a time period of 0.5 second or longer has passed since the radio waves have been lost.

Change the switches of each of the channels on the screen to make the settings. The inputting of each of the Fail Safe positions is carried out by operating the stick to the desired position and holding it there while pressing the "CLEAR" key at the left of the screen.

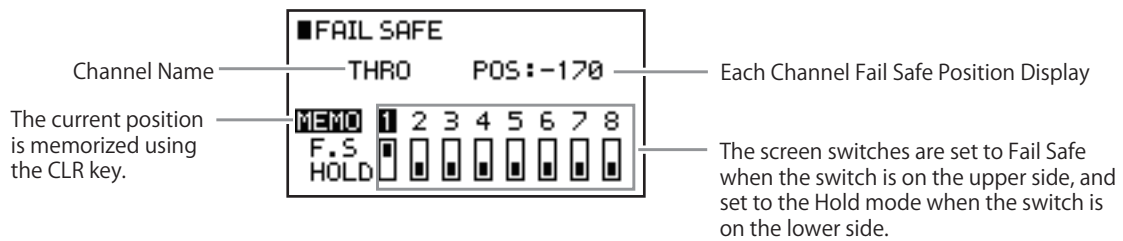

### Caution

- For safety reasons, engine-powered and electric-powered aircraft must have their motive power channels set to the slowest speed.
- If the Reverse Switches or Stick Mode are changed after setting the Fail Safe, the motive power may be set to the Full Throttle position. In order to avoid making dangerous mistakes, be certain to remember to implement the Fail Safe settings after completing the aircraft set-up.
- Before flying, be certain to confirm by switching off the transmitter power that each of the aircraft servos moves to the Fail Safe positions as intended.



# ALL SERVO HOLD [ALL SV HLD]



## Function Explanation

This function fixes (holds) all the servos in their current positions. It is used when the operator does not wish to move the servos such as during adjustments. When this function is set to on, the "SERVO HOLD" message will flash at the left side of the Initial INFO screen.



## Setting Method

For items on the Setting screen that are set to "OFF", set them to "ON" by pressing the dial. When this has been done, the Reconfirmation screen will be displayed, so confirm the setting by pressing "YES".

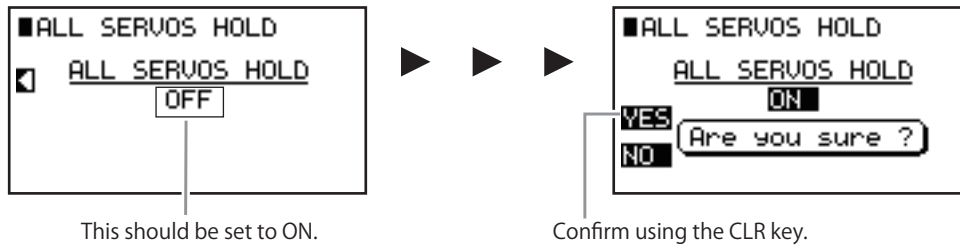



# THROTTLE STICK DIRECTION [STK DIRECT]

## Function Explanation

- Normally the Throttle Stick is set so that down is the slow side and up is the high side. This function reverses these directions. In the case of gliders, normally up is set to spoiler closed and down is spoiler open. This will be set to the opposite. Because the Throttle Stick operation will also be related to each of the mixing amounts, this function is different from the Reverse Switch function.

## Setting Method

- Select the Stick name on the screen, then press the dial to change the switch direction. NORM will set the normal direction while REV will set the opposite direction.

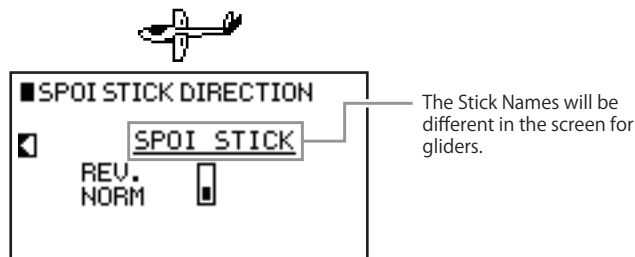
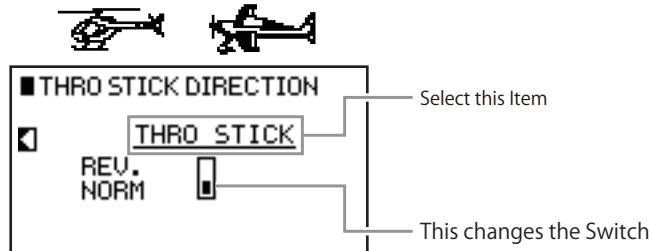

## Each Function in the System List



# STICK MODE [STK MODE]

## Function Explanation

- This function changes the left and right stick channel arrangement. Normally, Mode 1 is mainly used in Japan, while Mode 2 is mainly used in the USA. Enjoy operating the transmitter using your preferred style.

## Setting Method

- Rotate the dial to select the Mode No. on the screen, and press the dial to switch the mode. The screen will display the channel numbers allocated in each direction.

1: Throttle Operation 2: Aileron Operation 3: Elevator Operation 4: Rudder Operation

### Mode 1 (Mainstream in Japan)

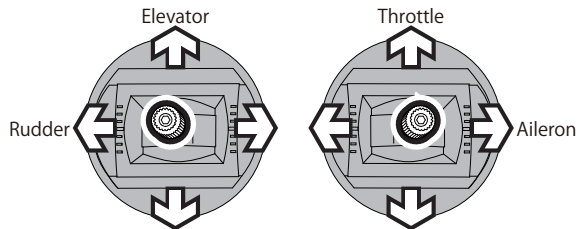
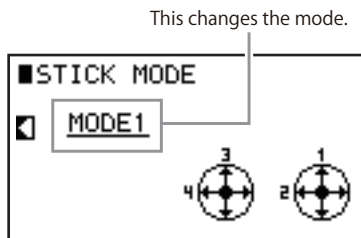

### Mode 2 (Mainstream in USA)

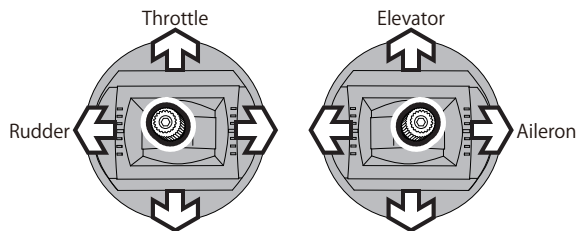
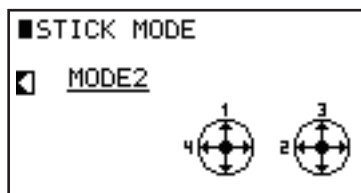

### Mode 3

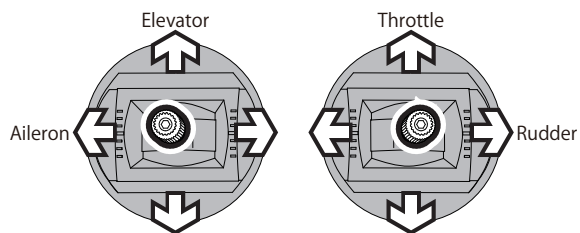
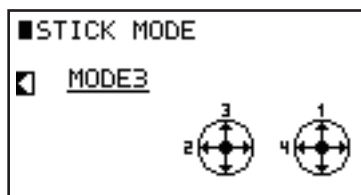

### Mode 4

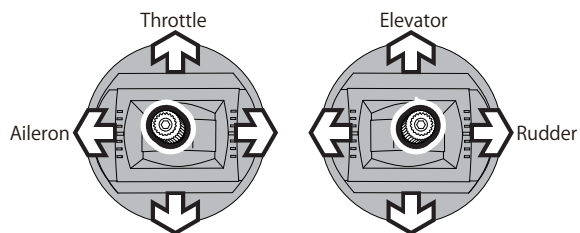
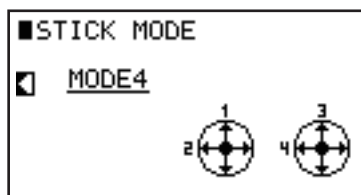

### Caution Item

- In the case where mode switching has been carried out, replacement/moving of some of the stick springs may be required.



# DEVICE SELECT [DEVICE SEL]

## Function Explanation

- In this screen, consideration should be made of which channels the switches and levers should be input to, and of how the channel output destinations should be set, together with the screens in which these switches and levers have their connections changed. Note that the items which can be changed are the channels and switches that are not fixed. The screen display contents and selections will be different according to the functions that have already been selected.

## Setting Method

- The setting screen has two pages. In Page 1, the Flight Mode switch selection is carried out. Rotate the dial to move to the setting item (inverse display) to select it. Then press the dial to display the setting box, and carry out the switch setting. For helicopters and gliders, the Flight Mode Extension switches can also be increased.

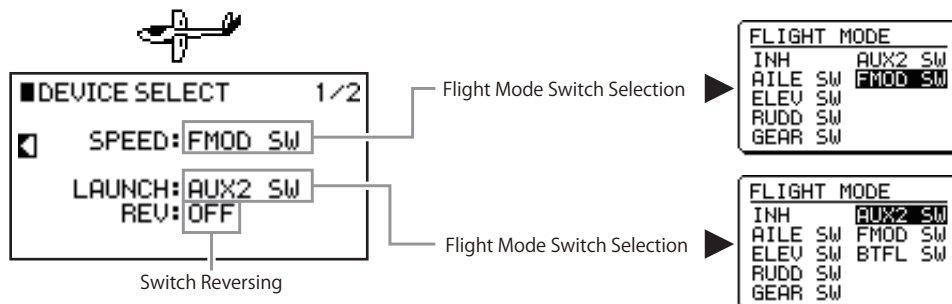
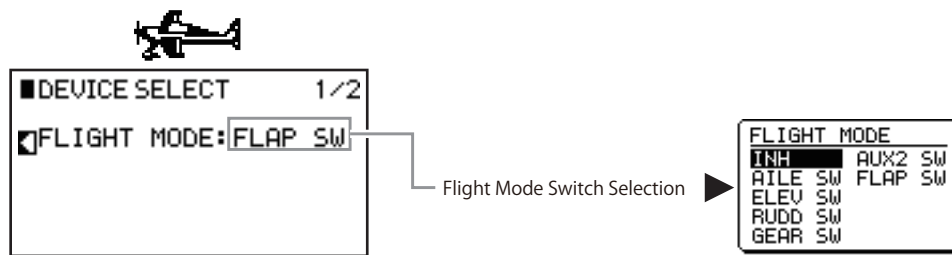
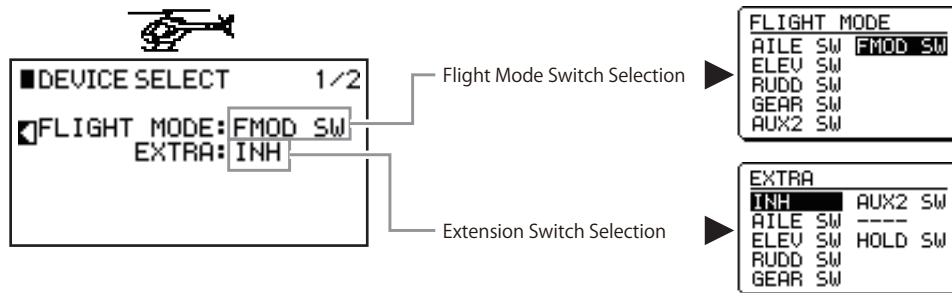

### Hints

- When selecting a switch, by operating the switch that you wish to use, the switch will be automatically set.
- When the Flight Mode switches have been increased, an order of priority will be created between switches. Please confirm this using the display on the Initial INFO screen.



# DEVICE SELECT Continued [DEVICE SEL]



## Setting Method

- On page 2, the actual connection settings can be carried out.

CH	DEVICE	OUT
5. GEAR:	GEAR SW	GYRO
7. AUX2:	AUX2 SW	ACT
8. AUX3:	AUX3 LV	ACT

Channel No.      Operation Input Device  
Channel Name      Channel Output Setting

Operation Input Device Setting Box Example

GEAR	1/2
AILE SW	FMOD SW
ELEV SW	HOLD SW
RUDD SW	TRN SW
GEAR SW	HPIT LV
AUX2 SW	AUX3 LV

Channel Output Setting Box Example

DEVICE SELECT 2/2	
GEAR	
INH	GYRO
ACT	NEEDLE
GOVERNOR	

CH	DEVICE	OUT
5. GEAR:	GEAR SW	ACT
6. FLAP:	FLAP SW	SYS
7. AUX2:	AUX2 SW	ACT
8. AUX3:	AUX3 LV	ACT

Channel No.      Operation Input Device  
Channel Name      Channel Output Setting

Operation Input Device Setting Box Example

GEAR	1/2
AILE SW	FLAP SW
ELEV SW	MIX SW
RUDD SW	SNAP SW
GEAR SW	FLAP LV
AUX2 SW	AUX3 LV

Channel Output Setting Box Example

DEVICE SELECT 2/2	
FLAP	
INH	GYRO
ACT	
SYSTEM	

CH	DEVICE	OUT
5. GEAR:	GEAR SW	ACT
6. FLAP:	FLAP LV	ACT
7. AUX2:	SPOI ST	ACT
8. AUX3:	AUX3 LV	ACT

Channel No.      Operation Input Device  
Channel Name      Channel Output Setting

Operation Input Device Setting Box Example

GEAR	2/2
SPOI ST	LTRM 2P
RTRM 3P	LTRM MO
RTRM 2P	
RTRM MO	
LTRM 3P	

Channel Output Setting Box Example

DEVICE SELECT 2/2	
AUX3	
INH	
ACT	
MOTOR	

### Hints

- When selecting a switch, by operating the switch that you wish to use, the switch will be automatically set.
- The RTRM Right Trim and LTRM Left Trim operations can be selected from three types. Actually carry out the operation to confirm the selection.  
MO: Momentary Operation 2P: 2 position 3P: 3 position
- Because ACT is the normal output, if the setting is set to INH nothing will be output during operation and the position will be fixed at neutral.  
However, this will function as the Program Mix Master Channel.

### Caution Items

- ! Actually operate the servos and carefully confirm the settings before flying.



# SWASH TYPE [SWASH TYPE]

## Function Explanation

This function carries out setting to match the structure of the helicopter swash plate. After making the settings in this function, detailed settings should be made using Swash Mixing in the Function List.

## Setting Method

Select the Swash type on the screen by rotating the dial, and press the dial. This displays a list of the Swash Patterns, so select the pattern.

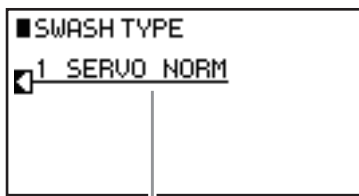

Swash Type

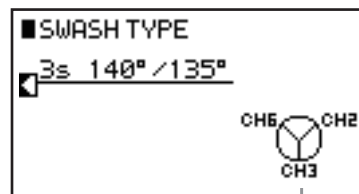

Swash/Servo Connection





# WING TYPE [WING TYPE]

## Function Explanation

- This carries out settings corresponding to the aircraft wing type. It sets dual ailerons, dual flaps, dual elevators, dual rudders, tailless planes, and V-tail wings.

## Setting Method

- The Setting screen is separated into the upper part for selecting the wing type, and the lower part for the dual settings of each control surface.

### Screen for Airplanes

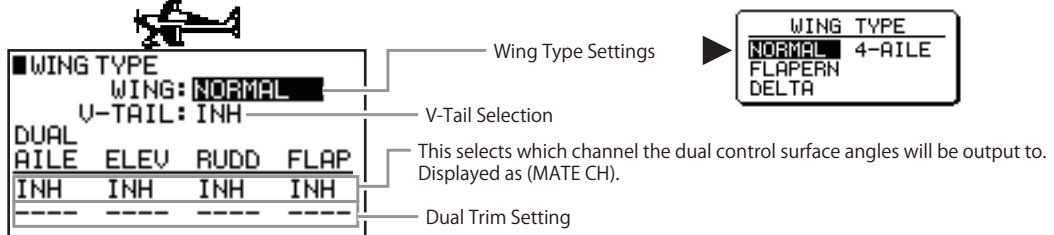

### Hint What is Dual Trim?

- Taking Dual Elevators as an example, in Elevator Trim the up and down movement of each control surface can be moved simultaneously. However, when the trims are increased, they will have an effect as a trim in the opposite direction. This function provides a convenient trim for carrying out simple correction in response to the displacement of linkages and twisting of control surfaces.

## Setting Examples

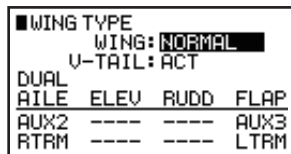

- Dual Ailerons and Dual Flaps are incorporated. The aileron Dual Trim is set to the Right Trim, while the Flap Auxiliary Trim is set to the Left Trim. The tail is a V-tail.

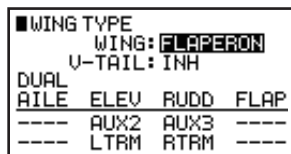

- Flaperons are incorporated in which the ailerons are capable of flap operation, while the Dual Elevator output is set to AUX2 and the Dual Rudder is set to AUX3. The elevator Auxiliary Trim is set to the Left Trim, while the Rudder Auxiliary Trim is set to the Right Trim. The tail is a normal specification.

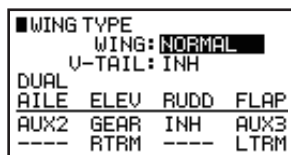

- Dual Ailerons are incorporated and the output is set to AUX2. The Dual Elevator output is set to the Right Trim as Auxiliary Trim using GEAR. The wing root base flaps are also dual incorporation, and the Auxiliary Trim is set to the Left Trim. The tail is a normal specification.

### Hints

- Because this receiver has 8 channels, depending on the settings the number of auxiliary channels will be limited. In the following screen, the remaining channel boxes will be automatically displayed. In the situation where there are no channels remaining for allocation, the "----" display will be shown.
- In the situation of the Glider type, the flaperons will be set as standard.

### Caution Items

- ⚠ Actually move the servos and carefully confirm the settings before flying.
- ⚠ For the settings in this function, confirm using the Servo Monitor Screen or by actually moving the servos.



## Each Function in the System List



# WING TYPE (Continued) [WING TYPE]



### ● Screen for Gliders

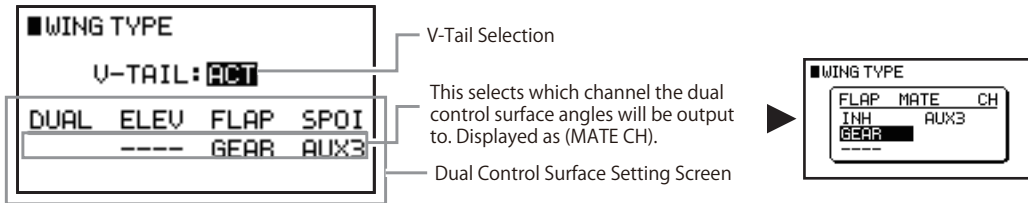

**! Caution** In the situation where Glider has been selected as the model type, the Dual Trim (Auxiliary Trim) function will not be able to be used

### Caution Items

- !** For the settings in this function, confirm using the Servo Monitor Screen or by actually moving the servos.



# BINDING & RANGE CHECKING [BIND & RANGE]

## Function Explanation

- This function carries out binding (pairing) with the receiver. In addition, the function can reduce the output for carrying out range checking.

## Setting Method

### ● Binding

- Set the receiver to the Binding Standby condition. Then rotate the dial to select "BIND" (inverse display) and press the dial. Some time will be required for the binding to be carried out. After completion of the binding the servos will begin to move.

### ● Range Checking

- If POWER is changed from "NORMAL" to "LOW", the output will be reduced and the LED will flash, allowing range checking to be carried out. When this screen is exited, the output will return to normal.

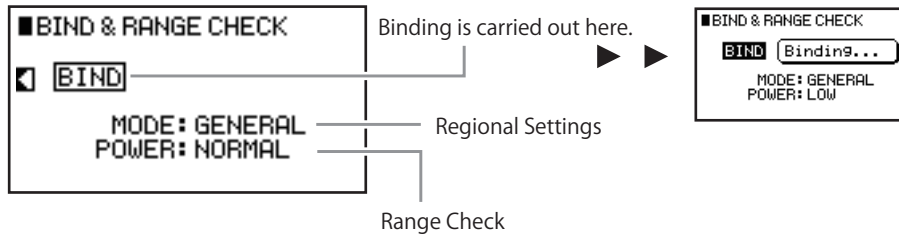

### ● Regional Settings

- When using the transmitter in France and its overseas territories, this should be set to "FRANCE". In all other regions this should be set to "GENERAL". In the France mode, the 2.4G bandwidth that is used will be legally restricted compared to the bandwidth in other regions.

## Hints

- In the Range Checking mode, keeping a distance approximately 40m from the aircraft, confirm that the transmitter operates the aircraft normally from each direction.
- Binding should be carried out in a location where there are no other 2.4GHz radio waves, and the receiver should be kept within 1m.

### Caution Items

- ⚠ When the model or type is changed using the transmitter, re-binding will be necessary.
- Absolutely do not fly the aircraft in Range Checking mode.

# Each Function in the System List



## TELEMETRY [TELEMETRY]

### Function Explanation

- This function carries out settings relating to telemetry, which allows confirmation of a variety of information from the aircraft using the transmitter. In addition to the screen numerical values, because alarms are incorporated that can be set to desired values, the aircraft conditions can be confirmed without taking your eyes off the aircraft. (However, it will be necessary to connect various sensors to the receiver.)

### Setting Method

- It is possible to select each of the screen items and set them. Each alarm can be demonstrated by clicking on the mark. Select each item to move to the Setting screens.

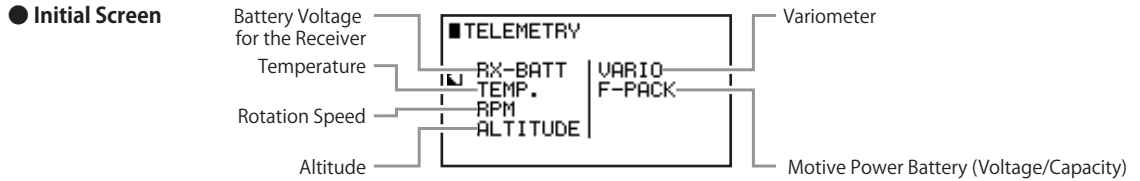

This screen is the Setting screen. The Telemetry Information display screen can be displayed from the Initial INFO screen by rotating the dial to the right. (See explanation on next page.)

**Receiver Battery**

- RX BATTERY**
- ALARM: 4.4V
- NO LINK ALARM: 10s

This sets the voltage where the alarm will sound. At the same time, the Telemetry screen will flash. (3.0V-9.0V)

This is the time between the interruption of the data from the receiver and the sounding of the alarm.

**Temperature**

- TEMPERATURE**
- SCALE: °C
- ALARM: 105°C

This selects the units. (°C, °F)

This sets the temperature where the alarm will sound. (30-500°C)

**Rotation Speed**

- RPM**
- GEAR RATIO: 1.00
- PROPELLER: 2
- DELAY: 0.5s

This selects the gear ratio (if a gearbox is used)

This is the Number of Blades (1-5)

This is the Delay Time of the Measurement Display in the Maximum Hold Value Display Screen (0.5-10.0 secs) Measurement Pause after Switching the Flight Mode

**Altimeter**

- ALTITUDE** ON
- SCALE: m
- SOUND1: 30m
- SOUND2: 50m
- SOUND3: 120m
- SW SEL

Units (Meters or Feet)

The altitudes at which the alarm will sound can be set. Alarm altitude (1-2000m)

Three types of alarm sounds are incorporated.

- ↑ : When the altitude becomes greater than the set value.
- ↓ : When the altitude becomes less than the set value.
- ~ : When flying within the set altitude range.

It is possible to switch ON/OFF the alarm sound using the selected switch.

**Variometer**

- VARIOMETER** ON
- SCALE: m
- UP SOUND SW SEL
- SOUND1: 0.5m/s
- SOUND2: 1.0m/s
- SOUND3: 1.5m/s
- SOUND4: 2.0m/s

On Page 1, settings during ascending can be made, and on Page 2 settings during descending can be made.

Units (m/sec. or feet/sec.)

It is possible to switch ON/OFF the alarm sound using the selected switch.

Setting is possible of the ascending rate at which the alarm sounds on Page 1, and of the descending rate at which the alarm sounds on Page 2. m/sec.: This shows the ascending and descending rate of the altitude.

**For Motive Power Battery**

- FLIGHT PACK**
- VOLT-ALARM: 6.4V
- CAPACITY: 2200mAh
- CAPA-ALARM: 22%
- ( 484mAh)

Voltage at which the alarm sounds (0.1V-655.3V)

Battery Nominal Capacity Value (0mAh-30000mAh)

Remaining Amount Alarm: An alarm will sound when the input battery nominal capacity remainder falls below the set rate.

**Caution** Because these sensors are not measuring instruments, no warranty is made for the accuracy of the measurement results.

## Each Function in the System List



# TELEMETRY (Continued) [TELEMETRY]

## Function Explanation

- By rotating the dial to the right when in the Initial INFO screen, this screen will be displayed. In this screen, it will be possible to display your desired Telemetry information together with the Timer and Flight Mode in a screen that customers can set so that it will be easy to use.

## Setting Method

- By clicking on "INH", the Item screens that can be shown will be displayed, so select the item that you wish to display. In the lower line "-----" location the information from the selected Telemetry sensor will be displayed. However, this will only be displayed when the receiver is switched on and the sensor is connected.

### Screen Initial Condition

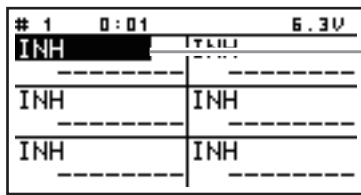

### Item Selection Screen

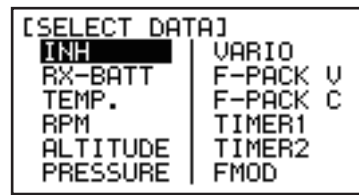

### Screen Display Example

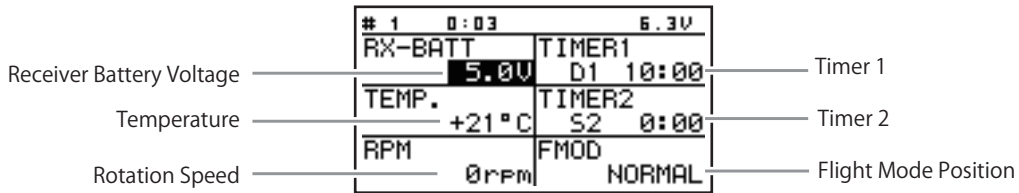

Using this screen, when the numerical values of each piece of Telemetry information are clicked, it will be possible to view useful information such as the minimum value (MIN), maximum value (MAX), and the used current capacity while flying, although there will be differences depending on the type of sensor.

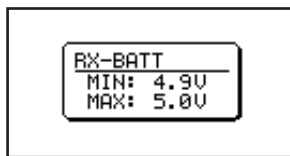

The receiver battery voltage maximum and minimum values will be recorded. Using the minimum values, the servo loading on the battery can be understood.

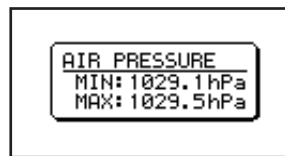

The air pressure maximum values and minimum values will be recorded.

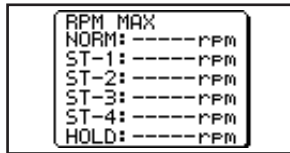

In the case of helicopters, the maximum rotation speed in each Flight Mode will be recorded.

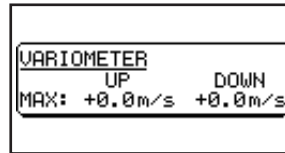

The variometer maximum values and minimum values can be viewed.

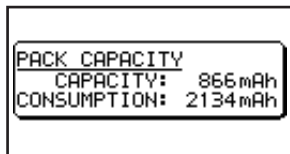

The remaining capacity of the motive power battery and the battery capacity that has been used can be confirmed.

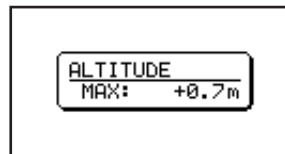

The maximum altitude during the flight will be recorded.

### Caution

Because these sensors are not measuring instruments, no warranty is made for the accuracy of the measurement results.



# Data Sheet for Helicopters



## XG8 DATA SHEET HELI

MODEL NO. \_\_\_\_\_  
 MODEL NAME \_\_\_\_\_

FLIGHT MODE NAME	NORMAL(NORM)	STNT-1(ST-1)	STNT-2(ST-2)	STNT-3(ST-3)	STNT-4(ST-4)	HOLD(HOLD)
LONG						
SHORT						

	THRO	AILE	ELEV	RUDD	GEAR	PIT.	AUX2	AUX3
REVERSE SW	NORM REV	NORM REV	NORM REV	NORM REV	NORM REV	NORM REV	NORM REV	NORM REV
SUB TRIM								
TRAVEL ADJUST	H % L %	D % L %	+ % H %	+ % + %				
	L % R %	U % R %	- % L %	- % - %				
FAIL SAFE								
SERVO SPEED	↑/← NORM· sec	NORM· sec	NORM· sec	NORM· sec	NORM· sec	NORM· sec	NORM· sec	NORM· sec
	↑/← NORM· sec	NORM· sec	NORM· sec	NORM· sec	NORM· sec	NORM· sec	NORM· sec	NORM· sec
SW SELECT	ON NORM·ST-1·ST-2·ST-3·ST-4·HOLD·AILE-0/1/2·ELEV-0/1/2·RUDD-0/1/2·GEAR-0/1/2·AUX2-0/1/2·FMOD-0/1/2·HOLD-0/1·TRN-0/1·SPS-0/1							

GOVERNOR	
Channel	
NORM	%
ST-1	%
ST-2	%
ST-3	%
ST-4	%
HOLD	%
TRIM IN	

CROSS TRIM	THRO/HV.T	INH ACT	SW	ON AND	NORM·ST-1·ST-2·ST-3·ST-4·HOLD·AILE-0/1/2·ELEV-0/1/2·RUDD-0/1/2·GEAR-0/1/2·AUX2-0/1/2·FMOD-0/1/2·HOLD-0/1·TRN-0/1·SPS-0/1
	ELEV/HV.P	INH ACT	SW	ON AND	NORM·ST-1·ST-2·ST-3·ST-4·HOLD·AILE-0/1/2·ELEV-0/1/2·RUDD-0/1/2·GEAR-0/1/2·AUX2-0/1/2·FMOD-0/1/2·HOLD-0/1·TRN-0/1·SPS-0/1

A.D.T.		THRO	AILE	ELEV	RUDD	HOV.PITCH	HOV.THRO
	NORM						
	ST-1						
	ST-2						
	ST-3						
	ST-4						
HOLD							
TRIM STEP							
TRIM TYPE	IDLE·NORM	L.S.T.·NORM	L.S.T.·NORM	L.S.T.·NORM	STUNT TRIM	COM·FMOD	

THRO HOLD	INH ACT	HOLD Pos.	%
		STICK AUTO	INH·( )
	Delay	INH·( ) s	
SW	AILE-0/1/2·ELEV-0/1/2·RUDD-0/1/2·GEAR-0/1/2·AUX2-0/1/2·FMOD-0/1/2·HOLD-0/1·TRN-0/1·SPS-0/1		

STICK POS SW	Stick	SYM	AREA	POS	POS
	SPS0		OFF·ON		
SPS1		OFF·ON			

Dual-Rate · EXP	Pos0	D/R	AILE	ELEV	RUDD	
			%	%	%	
		EXP	%	%	%	
			%	%	%	
		Pos1	D/R	%	%	%
			EXP	%	%	%
	Pos2	D/R	%	%	%	
		EXP	%	%	%	
	AUTO	NORM				
		ST-1				
		ST-2				
		ST-3				
		ST-4				
	HOLD					
	INPUT SW	AILE · ELEV · RUDD · FMOD				

SWASH MIX	TYPE	1s · 2s180° · 3s120° · 3s140°/135° · 3s90° · 4s90°			
	AILE	%	PIT.	%	
	ELEV	%	EXP	INH·ACT	
	AILE→ELEV	L: %	R: %		
	ELEV→AILE	D: %	U: %		
	SW SELECT	ON NORM·ST-1·ST-2·ST-3·ST-4·HOLD·AILE-0/1/2·ELEV-0/1/2·RUDD-0/1/2·GEAR-0/1/2·AUX2-0/1/2·FMOD-0/1/2·HOLD-0/1·TRN-0/1·SPS-0/1			
	PIT.→AILE	H: %	L: %		
	PIT.→ELEV	H: %	L: %		
	SW SELECT	ON NORM·ST-1·ST-2·ST-3·ST-4·HOLD·AILE-0/1/2·ELEV-0/1/2·RUDD-0/1/2·GEAR-0/1/2·AUX2-0/1/2·FMOD-0/1/2·HOLD-0/1·TRN-0/1·SPS-0/1			
	E-RING	INH·ACT	%		

GYRO SENS			
TWO GYRO DUAL GAIN	Channel		
	TYPE	NORMAL·T.LOCK	NORMAL·T.LOCK
AILE D/R	NORM(Pos0)	T·N %	T·N %
ELEV D/R	ST-1(Pos1)	T·N %	T·N %
	ST-2(Pos2)	T·N %	T·N %
RUDD D/R	ST-3	T·N %	T·N %
FMOD SW	ST-4	T·N %	T·N %
AUX2 SW	HOLD	T·N %	T·N %
AUTO	DELAY	s	
	TRIM IN		

\* Please make a copy for use.

# Data Sheet for Helicopters



## XG8 DATA SHEET HELI

		EXP		L	1	2	3	H	
THRO Curve	NORM	OFF•ON	IN	0				100	
			OUT						
	ST-1	OFF•ON	IN	0				100	
			OUT						
	ST-2	OFF•ON	IN	0				100	
			OUT						
	ST-3	OFF•ON	IN	0				100	
			OUT						
	ST-4	OFF•ON	IN	0				100	
			OUT						
PITCH Curve	NORM	OFF•ON	IN	0				100	
			OUT						
	ST-1	OFF•ON	IN	0				100	
			OUT						
	ST-2	OFF•ON	IN	0				100	
			OUT						
	ST-3	OFF•ON	IN	0				100	
			OUT						
	ST-4	OFF•ON	IN	0				100	
			OUT						
HOLD	OFF•ON	IN	0				100		
		OUT							
TAIL Curve	NORM	NORM ORIG	OFF•ON	IN	0			100	
				OUT					
	ST-1	NORM ORIG	OFF•ON	IN	0			100	
				OUT					
	ST-2	NORM ORIG	OFF•ON	IN	0			100	
				OUT					
	ST-3	NORM ORIG	OFF•ON	IN	0			100	
				OUT					
	ST-4	NORM ORIG	OFF•ON	IN	0			100	
				OUT					
STUNT MIX RATE: 1/1 • 1/2 • 1/4 • 1/10		MASTER	EXP		L	1	2	3	H

MIX→THRO	CHANNEL	AILE → THRO		ELEV → THRO		RUDD → THRO	
	Gain	L: %	R: %	D: %	U: %	L: %	R: %
	SW SEL	ON • NORM•ST-1•ST-2•ST-3•ST-4•HOLD AILE-0/1/2•ELEV-0/1/2•RUDD-0/1/2 AND GEAR-0/1/2•AUX2-0/1/2•FMOD-0/1/2 HOLD-0/1•TRN-0/1•SPS-0/1		ON • NORM•ST-1•ST-2•ST-3•ST-4•HOLD AILE-0/1/2•ELEV-0/1/2•RUDD-0/1/2 AND GEAR-0/1/2•AUX2-0/1/2•FMOD-0/1/2 HOLD-0/1•TRN-0/1•SPS-0/1		ON • NORM•ST-1•ST-2•ST-3•ST-4•HOLD AILE-0/1/2•ELEV-0/1/2•RUDD-0/1/2 AND GEAR-0/1/2•AUX2-0/1/2•FMOD-0/1/2 HOLD-0/1•TRN-0/1•SPS-0/1	

FLIGHT MODE DELAY	THRO	AILE	ELEV	RUDD	GEAR	PIT.	AUX2	AUX3
	NORM	INH• s	INH• s	INH• s	INH• s	INH• s	INH• s	INH• s
	ST-1	INH• s	INH• s	INH• s	INH• s	INH• s	INH• s	INH• s
	ST-2	INH• s	INH• s	INH• s	INH• s	INH• s	INH• s	INH• s
	ST-3	INH• s	INH• s	INH• s	INH• s	INH• s	INH• s	INH• s
	ST-4	INH• s	INH• s	INH• s	INH• s	INH• s	INH• s	INH• s
HOLD	INH• s	INH• s	INH• s	INH• s	INH• s	INH• s	INH• s	

THRO TRIM	THRO CUT	INH•ACT	TRIM MEMORY	INH•ACT
	THRO	+ / -	%	TIME LAG: INH• s
	SW SEL	AILE-0/1/2•ELEV-0/1/2•RUDD-0/1/2 GEAR-0/1/2•AUX2-0/1/2•FMOD-0/1/2 HOLD-0/1•TRN-0/1•SPS-0/1		

TIMER		TIMER 1	TIMER 2
	Timer	Down-T•STOP W	Down-T•STOP W
	Time	10'00"	10'00"
	START		
	STOP		

\* Please make a copy for use.

# Data Sheet for Helicopters



## YG8 DATA SHEET HELI

PROGRAM MIX	MIX1	CHANNEL			+GAIN	-GAIN	OFFSET
		→			%	%	
		EXP	L	1	2	3	H
		OFF-ON	IN 0				100
		OUT					
	SW SELECT	ON NORM•ST-1•ST-2•ST-3•ST-4•HOLD•AILE-0/1/2•ELEV-0/1/2•RUDD-0/1/2 GEAR-0/1/2•AUX2-0/1/2•FMOD-0/1/2•HOLD-0/1•TRN-0/1•SPS-0/1					
	MIX2	CHANNEL			+GAIN	-GAIN	OFFSET
		→			%	%	
		EXP	L	1	2	3	H
		OFF-ON	IN 0				100
		OUT					
	SW SELECT	ON NORM•ST-1•ST-2•ST-3•ST-4•HOLD•AILE-0/1/2•ELEV-0/1/2•RUDD-0/1/2 GEAR-0/1/2•AUX2-0/1/2•FMOD-0/1/2•HOLD-0/1•TRN-0/1•SPS-0/1					
	MIX3	CHANNEL			+GAIN	-GAIN	OFFSET
		→			%	%	
		EXP	L	1	2	3	H
		OFF-ON	IN 0				100
		OUT					
	SW SELECT	ON NORM•ST-1•ST-2•ST-3•ST-4•HOLD•AILE-0/1/2•ELEV-0/1/2•RUDD-0/1/2 GEAR-0/1/2•AUX2-0/1/2•FMOD-0/1/2•HOLD-0/1•TRN-0/1•SPS-0/1					
	MIX4	CHANNEL			+GAIN	-GAIN	OFFSET
		→			%	%	
		EXP	L	1	2	3	H
		OFF-ON	IN 0				100
		OUT					
	SW SELECT	ON NORM•ST-1•ST-2•ST-3•ST-4•HOLD•AILE-0/1/2•ELEV-0/1/2•RUDD-0/1/2 GEAR-0/1/2•AUX2-0/1/2•FMOD-0/1/2•HOLD-0/1•TRN-0/1•SPS-0/1					
MIX5	CHANNEL			+GAIN	-GAIN	OFFSET	
	→			%	%		
	EXP	L	1	2	3	H	
	OFF-ON	IN 0				100	
	OUT						
SW SELECT	ON NORM•ST-1•ST-2•ST-3•ST-4•HOLD•AILE-0/1/2•ELEV-0/1/2•RUDD-0/1/2 GEAR-0/1/2•AUX2-0/1/2•FMOD-0/1/2•HOLD-0/1•TRN-0/1•SPS-0/1						
MIX6	CHANNEL			+GAIN	-GAIN	OFFSET	
	→			%	%		
	EXP	L	1	2	3	H	
	OFF-ON	IN 0				100	
	OUT						
SW SELECT	ON NORM•ST-1•ST-2•ST-3•ST-4•HOLD•AILE-0/1/2•ELEV-0/1/2•RUDD-0/1/2 GEAR-0/1/2•AUX2-0/1/2•FMOD-0/1/2•HOLD-0/1•TRN-0/1•SPS-0/1						

WARNING	THRO STICK	ACT • INH	POS.	10 • ( )	AREA	HIGH • LOW
	AND NORM•ST-1•ST-2•ST-3•ST-4•HOLD•AILE-0/1/2•ELEV-0/1/2•RUDD-0/1/2•GEAR-0/1/2•AUX2-0/1/2•FMOD-0/1/2•HOLD-0/1•TRN-0/1•SPS-0/1					

DEVICE SELECT	FLIGHT MODE	FLIGHT MODE EXTRA	CH	GEAR	AUX2	AUX3
		INH	DEVICE	GEAR SW	AUX2 SW	AUX3 LV
			OUT	INH•ACT GOV•GYR NEDL	INH•ACT GOV•GYR NEDL	INH•ACT GOV•GYR NEDL

\* Please make a copy for use.



# Data Sheet for Helicopters



## XG8 DATA SHEET

**HELI**

TRIM INPUT SW	TRIM	SW SEL
	TISO	AND NORM•ST-1•ST-2•ST-3•ST-4•HOLD•AILE-0/1/2•ELEV-0/1/2•RUDD-0/1/2 GEAR-0/1/2•AUX2-0/1/2•FMOD-0/1/2•HOLD-0/1•TRN-0/1•SPS-0/1
	TIS1	AND NORM•ST-1•ST-2•ST-3•ST-4•HOLD•AILE-0/1/2•ELEV-0/1/2•RUDD-0/1/2 GEAR-0/1/2•AUX2-0/1/2•FMOD-0/1/2•HOLD-0/1•TRN-0/1•SPS-0/1
	TIS2	AND NORM•ST-1•ST-2•ST-3•ST-4•HOLD•AILE-0/1/2•ELEV-0/1/2•RUDD-0/1/2 GEAR-0/1/2•AUX2-0/1/2•FMOD-0/1/2•HOLD-0/1•TRN-0/1•SPS-0/1
	TIS3	AND NORM•ST-1•ST-2•ST-3•ST-4•HOLD•AILE-0/1/2•ELEV-0/1/2•RUDD-0/1/2 GEAR-0/1/2•AUX2-0/1/2•FMOD-0/1/2•HOLD-0/1•TRN-0/1•SPS-0/1

STICK ALERT	ACT•INH	POS
	NORM•ST-1•ST-2•ST-3•ST-4•HOLD•AILE-0/1/2 ELEV-0/1/2•RUDD-0/1/2•GEAR-0/1/2•AUX2-0/1/2 FMOD-0/1/2•HOLD-0/1•TRN-0/1•SPS-0/1	

THRO STICK DIRECTION	REV•NORM
STICK MODE	

ALTITUDE	SOUND 1	m/ft	↑•↓•~	m/ft
	SOUND 2	m/ft	↑•↓•~	m/ft
	SOUND 3	m/ft	↑•↓•~	m/ft
	SW SEL	ON NORM•ST-1•ST-2•ST-3•ST-4•HOLD•AILE-0/1/2 • ELEV-0/1/2•RUDD-0/1/2•GEAR-0/1/2•AUX2-0/1/2 AND FMOD-0/1/2•HOLD-0/1•TRN-0/1•SPS-0/1		

VARIOMETER	SOUND 1	m/s•fps
	SOUND 2	m/s•fps
	SOUND 3	m/s•fps
	SOUND 4	m/s•fps
	SW SEL	NORM•ST-1•ST-2•ST-3 ST-4•HOLD•AILE-0/1/2 ELEV-0/1/2•RUDD-0/1/2 GEAR-0/1/2•AUX2-0/1/2 FMOD-0/1/2•HOLD-0/1 TRN-0/1•SPS-0/1

TEMPERATURE	ALARM
	INH• ( °C/°F)

RX-BATTERY	ALARM
	INH• ( v)

RPM	GEAR RATIO	PROPELLER	DELAY
	INH• ( )	INH• ( )	INH• ( )

FLIGHT PACK	VOLT-ALARM	CAPACITY	CAPA-ALARM
	INH• ( v)	mAh	INH• ( %)

NO LINK ALARM	INH•
	10s•15s
	20s•30s

\* Please make a copy for use.

# Data Sheet for Airplanes



## XG8 DATA SHEET

**ACRO**

MODEL NO. \_\_\_\_\_

MODEL NAME \_\_\_\_\_

FLIGHT MODE NAME	FMOD-0(FM-0)	FMOD-1(FM-1)	FMOD-2(FM-2)
LONG			
SHORT			

STICK POS SW	Stick	SYM	AREA	POS
	SPS0		OFF-ON	
SPS1		OFF-ON		

	THRO	AILE	ELEV	RUDD	GEAR	FLAP	AUX2	AUX3
REVERSE SW	NORM REV	NORM REV	NORM REV	NORM REV	NORM REV	NORM REV	NORM REV	NORM REV
SUB TRIM								
TRAVEL ADJUST	H % L % L % R %	D % L % U % R %	+ % U % - % D %					
FAIL SAFE								
SERVO SPEED	↑/← NORM • sec	NORM • sec	NORM • sec	NORM • sec	NORM • sec	NORM • sec	NORM • sec	NORM • sec
	↓/→ NORM • sec	NORM • sec	NORM • sec	NORM • sec	NORM • sec	NORM • sec	NORM • sec	NORM • sec
SW SELECT	AND FM-0/1/2 • AILE-0/1/2 • ELEV-0/1/2 • RUDD-0/1/2 • GEAR-0/1/2 • AUX2-0/1/2 • FLAP-0/1/2 • MIX-0/1 • SNAP-0/1 • SPS-0/1 THRO STK INH • ( )							

	THRO	AILE	ELEV	RUDD	FLAP	AUX
A.D.T.	FM-0					
	FM-1					
	FM-2					
TRIM STEP						
TRIM TYPE		L.S.T. • NORM	L.S.T. • NORM	L.S.T. • NORM	L.S.T. • NORM	
FMOD TRIM: COM • FMOD			THRO/ELEV TRIM: NORM • CROSS			
FLAP TRIM: ON • OFF			FLAP/AUX TRIM: NORM • CROSS			

GYRO SENS		TWO GYRO • DUAL GAIN	
AILE D/R	Channel		
ELEV D/R	TYPE	NORMAL • TLOCK	NORMAL • TLOCK
RUDD D/R	POS0(FM-0)	T-N %	T-N %
FLAP SW	POS1(FM-1)	T-N %	T-N %
AUX2 SW	POS2(FM-2)	T-N %	T-N %
AUTO	DELAY	INH • s	
	TRIM IN		

		AILE	ELEV	RUDD
Dual-Rate EXP	Pos0	D/R	%	%
			%	%
		EXP	%	%
	Pos1	D/R	%	%
			%	%
		EXP	%	%
	Pos2	D/R	%	%
			%	%
		EXP	%	%
	AUTO	FM-0		
		FM-1		
		FM-2		
INPUT SW		AILE • ELEV • RUDD • FLAP		

			AILE	ELEV	RUDD
SNAP ROLL	S.ROLL0	INH • ACT	RATE %	%	%
			STICK POS		
			SW	ON • FM-0 • FM-1 • FM-2 • SNAP	
	S.ROLL1	INH • ACT	RATE %	%	%
			STICK POS		
			SW	ON • FM-0 • FM-1 • FM-2 • SNAP	
	S.ROLL2	INH • ACT	RATE %	%	%
			STICK POS		
			SW	ON • FM-0 • FM-1 • FM-2 • SNAP	
	S.ROLL3	INH • ACT	RATE %	%	%
			STICK POS		
			SW	ON • FM-0 • FM-1 • FM-2 • SNAP	

TIMER		TIMER 1	TIMER 2
	Timer	Down-T • STOP W	Down-T • STOP W
	Time	10'00"	10'00"
	START		
	STOP		

WARNING	THRO STICK	ACT • INH	POS.	10 • ( )	AREA	HIGH • LOW
AND FM-0/1/2 • AILE-0/1/2 • ELEV-0/1/2 • RUDD-0/1/2 • GEAR-0/1/2 • AUX2-0/1/2 • FLAP-0/1/2 • MIX-0/1 • SNAP-0/1 • SPS-0/1						

\* Please make a copy for use.

# Data Sheet for Airplanes



## XG8 DATA SHEET ACRO

THRO CURVE	EXP		L	1	2	3	H
	OFF-ON	IN	0				100
		OUT					
SW SELECT	AND FM-0/1/2•AILE-0/1/2•ELEV-0/1/2•RUDD-0/1/2•GEAR-0/1/2•AUX2-0/1/2 FLAP-0/1/2•MIX-0/1•SNAP-0/1•SPS-0/1						

FLAP SYSTEM		FLAP	ELEV	AILE	AILE→RUDD MIX	L: %	R: %	
	NORM	%	%	%		SW AND	FM-0/1/2•AILE-0/1/2•ELEV-0/1/2•RUDD-0/1/2•GEAR-0/1/2 AUX2-0/1/2•FLAP-0/1/2•MIX-0/1•SNAP-0/1•SPS-0/1	
	MID	%	%	%				
	LAND	%	%	%	ELEV→FLAP MIX	D: %	U: %	
	DELAY	INH• s	INH• s	INH• s		SW AND	FM-0/1/2•AILE-0/1/2•ELEV-0/1/2•RUDD-0/1/2•GEAR-0/1/2 AUX2-0/1/2•FLAP-0/1/2•MIX-0/1•SNAP-0/1•SPS-0/1	
	TRIM IN							
	FM-0	SW • NORM • MID • LAND						
FM-1	SW • NORM • MID • LAND			RUDD→ AIL/ELE MIX	→AILE L: %	R: %	TRIM IN	
FM-2	SW • NORM • MID • LAND				→ELEV L: %	R: %	TRIM IN	
AUTO THRO	INH				SW AND	FM-0/1/2•AILE-0/1/2•ELEV-0/1/2•RUDD-0/1/2•GEAR-0/1/2 AUX2-0/1/2•FLAP-0/1/2•MIX-0/1•SNAP-0/1•SPS-0/1		

WING TYPE	WING	NORMAL • FLAPERON • DELTA • 4-AILE				
	V-tail	INH•ACT				
	DUAL	AILE	ELEV	RUDD	FLAP	TWIN ENGINE
	MATE	INH•	INH•	INH•	INH•	INH•
	TRIM	INH•L / R	INH•L / R	INH•L / R	INH•L / R	INH•ACT

THRO TRIM	THRO CUT	INH•ACT	%	
		TIME LAG	INH• s	
		SW SELECT	AND FM-0/1/2•AILE-0/1/2 ELEV-0/1/2•RUDD-0/1/2 GEAR-0/1/2•AUX2-0/1/2 FLAP-0/1/2•MIX-0/1 SNAP-0/1•SPS-0/1	
	THROTRIM MEMORY	INH•ACT		
	IDLE ADJUST	SW SELECT	AND FM-0/1/2•AILE-0/1/2 ELEV-0/1/2•RUDD-0/1/2 GEAR-0/1/2•AUX2-0/1/2 FLAP-0/1/2•MIX-0/1 SNAP-0/1•SPS-0/1	

DIFFERENTIAL	AILE	%	TRIM IN
	SW AND	FM-0/1/2•AILE-0/1/2•ELEV-0/1/2•RUDD-0/1/2•GEAR-0/1/2 AUX2-0/1/2•FLAP-0/1/2•MIX-0/1•SNAP-0/1•SPS-0/1	
	RUDD	%	TRIM IN
	SW AND	FM-0/1/2•AILE-0/1/2•ELEV-0/1/2•RUDD-0/1/2•GEAR-0/1/2 AUX2-0/1/2•FLAP-0/1/2•MIX-0/1•SNAP-0/1•SPS-0/1	
	FLAP	%	TRIM IN
	SW AND	FM-0/1/2•AILE-0/1/2•ELEV-0/1/2•RUDD-0/1/2•GEAR-0/1/2 AUX2-0/1/2•FLAP-0/1/2•MIX-0/1•SNAP-0/1•SPS-0/1	

\* Please make a copy for use.

# Data Sheet for Airplanes



## XG8 DATA SHEET ACRO

PROGRAM MIX	MIX1	CHANNEL				Pos.0		Pos.1		OFFSET		
		→				%	%	%	%			
		INCLUDE:		INCLUDE:		SW: FM-0/1/2•AILE-0/1/2•ELEV-0/1/2•RUDD-0/1/2•GEAR-0/1/2 AND AUX2-0/1/2•FLAP-0/1/2•MIX-0/1•SNAP-0/1•SPS-0/1						
		EXP		L	1	2	3	H				
		OFF•ON	IN	0					100			
			OUT									
	MIX2	CHANNEL				Pos.0		Pos.1		OFFSET		
		→				%	%	%	%			
		INCLUDE:		INCLUDE:		SW: FM-0/1/2•AILE-0/1/2•ELEV-0/1/2•RUDD-0/1/2•GEAR-0/1/2 AND AUX2-0/1/2•FLAP-0/1/2•MIX-0/1•SNAP-0/1•SPS-0/1						
		EXP		L	1	2	3	H				
		OFF•ON	IN	0					100			
			OUT									
	MIX3	CHANNEL				Pos.0		Pos.1		OFFSET		
		→				%	%	%	%			
		INCLUDE:		INCLUDE:		SW: FM-0/1/2•AILE-0/1/2•ELEV-0/1/2•RUDD-0/1/2•GEAR-0/1/2 AND AUX2-0/1/2•FLAP-0/1/2•MIX-0/1•SNAP-0/1•SPS-0/1						
		EXP		L	1	2	3	H				
		OFF•ON	IN	0					100			
			OUT									
	MIX4	CHANNEL				Pos.0		Pos.1		OFFSET		
		→				%	%	%	%			
		INCLUDE:		INCLUDE:		SW: FM-0/1/2•AILE-0/1/2•ELEV-0/1/2•RUDD-0/1/2•GEAR-0/1/2 AND AUX2-0/1/2•FLAP-0/1/2•MIX-0/1•SNAP-0/1•SPS-0/1						
		EXP		L	1	2	3	H				
		OFF•ON	IN	0					100			
			OUT									
MIX5	CHANNEL				Pos.0		Pos.1		OFFSET			
	→				%	%	%	%				
	INCLUDE:		INCLUDE:		SW: FM-0/1/2•AILE-0/1/2•ELEV-0/1/2•RUDD-0/1/2•GEAR-0/1/2 AND AUX2-0/1/2•FLAP-0/1/2•MIX-0/1•SNAP-0/1•SPS-0/1							
	EXP		L	1	2	3	H					
	OFF•ON	IN	0					100				
		OUT										
MIX6	CHANNEL				Pos.0		Pos.1		OFFSET			
	→				%	%	%	%				
	INCLUDE:		INCLUDE:		SW: FM-0/1/2•AILE-0/1/2•ELEV-0/1/2•RUDD-0/1/2•GEAR-0/1/2 AND AUX2-0/1/2•FLAP-0/1/2•MIX-0/1•SNAP-0/1•SPS-0/1							
	EXP		L	1	2	3	H					
	OFF•ON	IN	0					100				
		OUT										

DEVICE SELECT	FLIGHT MODE	CH	GEAR	FLAP	AUX2	AUX3
		DEVICE	GEAR SW	FLAP SW	AUX2 SW	AUX3 LV
		OUT	INH•ACT GYR	INH•ACT SYS•GYR	INH•ACT SYS•GYR	INH•ACT SYS•GYR

\* Please make a copy for use.

# Data Sheet for Airplanes



## XG8 DATA SHEET

**ACRO**

TRIM INPUT SW		TRIM	SW SEL
	TIS0		AND FM-0/1/2•AILE-0/1/2•ELEV-0/1/2•RUDD-0/1/2•GEAR-0/1/2•AUX2-0/1/2 FLAP-0/1/2•MIX-0/1•SNAP-0/1•SPS-0/1
	TIS1		AND FM-0/1/2•AILE-0/1/2•ELEV-0/1/2•RUDD-0/1/2•GEAR-0/1/2•AUX2-0/1/2 FLAP-0/1/2•MIX-0/1•SNAP-0/1•SPS-0/1
	TIS2		AND FM-0/1/2•AILE-0/1/2•ELEV-0/1/2•RUDD-0/1/2•GEAR-0/1/2•AUX2-0/1/2 FLAP-0/1/2•MIX-0/1•SNAP-0/1•SPS-0/1
	TIS3		AND FM-0/1/2•AILE-0/1/2•ELEV-0/1/2•RUDD-0/1/2•GEAR-0/1/2•AUX2-0/1/2 FLAP-0/1/2•MIX-0/1•SNAP-0/1•SPS-0/1

STICK ALERT	ACT•INH	POS	
	ON	FM-0/1/2•AILE-0/1/2•ELEV-0/1/2 RUDD-0/1/2•GEAR-0/1/2•AUX2-0/1/2 FLAP-0/1/2•MIX-0/1•SNAP-0/1•SPS-0/1	

THRO STICK DIRECTION	REV•NORM
-------------------------	----------

STICK MODE	
------------	--

ALTITUDE	SOUND 1	m/ft	↑•↓•~	m/ft
	SOUND 2	m/ft	↑•↓•~	m/ft
	SOUND 3	m/ft	↑•↓•~	m/ft
	SW SEL	ON FM-0/1/2•AILE-0/1/2•ELEV-0/1/2•RUDD-0/1/2 • GEAR-0/1/2•AUX2-0/1/2•FLAP-0/1/2•MIX-0/1 AND SNAP-0/1•SPS-0/1		

VARIOMETER	SOUND 1	m/s•fps
	SOUND 2	m/s•fps
	SOUND 3	m/s•fps
	SOUND 4	m/s•fps
	SW SEL	ON•AND FM-0/1/2•AILE-0/1/2 ELEV-0/1/2•RUDD-0/1/2 GEAR-0/1/2•AUX2-0/1/2 FLAP-0/1/2•MIX-0/1 SNAP-0/1•SPS-0/1

TEMPERATURE	ALARM	
	INH• ( )	°C/°F

RX-BATTERY	ALARM	
	INH• ( )	v

RPM	GEAR RATIO	PROPELLER	DELAY
	INH• ( )	INH• ( )	INH• ( )

FLIGHT PACK	VOLT-ALARM	CAPACITY	CAPA-ALARM
	INH• ( )	v	mAh INH• ( % )

NO LINK ALARM	INH•
	10s•15s
	20s•30s

\* Please make a copy for use.

# Data Sheet for Gliders



## XG8 DATA SHEET GRID

MODEL NO. \_\_\_\_\_  
 MODEL NAME \_\_\_\_\_

FLIGHT MODE NAME	CRUISE	SPEED	THERMAL	LAUNCH	LAND
LONG					
SHORT					

	LAIL	RAIL	ELEV	RUDD	GEAR	FLAP	AUX2	AUX3
REVERSE SW	NORM REV	NORM REV	NORM REV	NORM REV	NORM REV	NORM REV	NORM REV	NORM REV
SUB TRIM								
TRAVEL ADJUST	H %	L %	D %	L %	+ %	U %	+ %	+ %
	L %	R %	U %	R %	- %	D %	- %	- %
LIMIT ADJUST	H %	L %	D %	L %	+ %	U %	+ %	+ %
	L %	R %	U %	R %	- %	D %	- %	- %
FAIL SAFE								
SERVO SPEED	↑/←	NORM·sec	NORM·sec	NORM·sec	NORM·sec	NORM·sec	NORM·sec	NORM·sec
	↓/→	NORM·sec	NORM·sec	NORM·sec	NORM·sec	NORM·sec	NORM·sec	NORM·sec
	SW SELECT	AND CRUI·SPEE·THRM·LAUN·LAND·AILE-0/1/2·ELEV-0/1/2·RUDD-0/1/2·GEAR-0/1/2·AUX2-0/1/2·FMOD-0/1/2·BTFL-0/1·TRN-0/1·SPS-0/1						

	SPOI	AILE	ELEV	RUDD	FLAP	FRPN
A.D.T.	CRUI					
	SPEE					
	THRM					
	LAUN					
	LAND					
TRIM STEP						
TRIM TYPE		L.S.T.·NORM	L.S.T.·NORM	L.S.T.·NORM		
AILE/RUDD TRIM	COM·FMOD		FPRN DIRECTION		NORM·REV.	

STICK	Stick	SYM	AREA	POS	POS
POS	SPS0	OFF·ON			
SW	SPS1	OFF·ON			

	TIMER 1	TIMER 2
Timer	Down-T·STOP W	Down-T·STOP W
Time	10'00"	10'00"
START		
STOP		

		AILE	ELEV	RUDD
Dual-Rate · EXP	Pos0	D/R	%	%
		EXP	%	%
			%	%
	Pos1	D/R	%	%
		EXP	%	%
			%	%
AUTO	D/R	%	%	
	EXP	%	%	
		%	%	
		%	%	
		%	%	
CRUI				
SPEE				
THRM				
LAUN				
LAND				
INPUT SW	AILE · ELEV · RUDD · FMOD			

WING TYPE	V-TAIL	INH	ACT
		MATE CHANNEL	
	DUAL ELEV	INH·GEAR·FLAP·AUX2·AUX3	
	DUAL FLAP	INH·GEAR·FLAP·AUX2·AUX3	
	DUAL SPOI	INH·GEAR·FLAP·AUX2·AUX3	

CAMP SYSTEM	DELAY	BREAK
	CRUISE	INH ACT
	SPEED	INH ACT
	THERMAL	INH ACT
	LAUNCH	INH ACT
	LAND	INH ACT
	BREAK BY ELEV STICK	

WARNING	SPOI STICK	ACT · INH	POS.	90 · ( )	AREA	OPEN·CLOSE
AND CRUI·SPEE·THRM·LAUN·LAND·AILE-0/1/2·ELEV-0/1/2·RUDD-0/1/2·GEAR-0/1/2·AUX2-0/1/2·FMOD-0/1/2·BTFL-0/1·TRN-0/1·SPS-0/1						

\* Please make a copy for use.

# Data Sheet for Gliders



## XG8 DATA SHEET

**GRID**

BRAKE SYSTEM	BRAKE START POSITION		SPOI STICK → SPOI		SPOI STICK → FPRN		SPOI STICK → FRAP	
			%		%		%	
	SW SELECT	ON CRUI•SPEE•THRM•LAUN•LAND•AILE-0/1/2•ELEV-0/1/2•RUDD-0/1/2•GEAR-0/1/2•AUX2-0/1/2 AND FMOD-0/1/2•BTFL-0/1•TRN-0/1•SPS-0/1						
	SPOI STICK → ELEV	EXP		POINT-O	POINT-1	POINT-2	POINT-3	POINT-C
OFF•ON		IN						
		OUT						
TRIM INPUT			INH •					

FLAP RATE			CRUISE	SPEED	THERMAL	LAUNCH	LAND	
	UP		%	%	%	%	%	
	DOWN		%	%	%	%	%	
FLAPERON MIXING	FLAP ↓ FPRN	UP	%	%	%	%	%	FLAP LEVER OFFSET
		DOWN	%	%	%	%	%	
	FLAP ↓ ELEV	UP	%	%	%	%	%	
		DOWN	%	%	%	%	%	
	AILE ↓ FLAP	LEFT	%	%	%	%	%	
		RIGHT	%	%	%	%	%	
ELEV → CAMB MIXING	ELEV ↓ FLAP	DOWN	%	%	%	%	%	
		UP	%	%	%	%	%	
	ELEV ↓ FPRN	DOWN	%	%	%	%	%	
		UP	%	%	%	%	%	
	OFFSET							
RUDD → SPOI MIXIG	RUDD → SPOI		%	%	%	%	%	
AILE → RUDD MIXING	AILE ↓ RUDD	LEFT	%	%	%	%	%	
		RIGHT	%	%	%	%	%	
	BREAK ELEV STICK		INH	BREAK RUDD STICK			INH	

MOTO SYSTEM	HOLD POSITION	%	HOLD DELAY	HIGH ↑	LOW ↓
	SW SELECT	ON CRUI•SPEE•THRM•LAUN•LAND•AILE-0/1/2•ELEV-0/1/2•RUDD-0/1/2•GEAR-0/1/2•AUX2-0/1/2 FMOD-0/1/2•BTFL-0/1•TRN-0/1•SPS-0/1			

DEVICE SELECT	SPEED MODE	LAUNCH MODE	CH	GEAR	FLAP	AUX2	AUX3
			DEVICE	GEAR SW	FLAP LV	SPOI ST	AUX3 LV
		REV.   NORM	OUT	INH•ACT•MOTO	INH•ACT	INH•ACT	INH•ACT•MOTO

\* Please make a copy for use.

# Data Sheet for Gliders



## XG8 DATA SHEET

**GRID**

PROGRAM MIX	MIX1	CHANNEL				Pos.0		Pos.1		OFFSET
		→				%	%	%	%	
		INCLUDE:		INCLUDE:		SW: CRUI•SPEE•THRM•LAUN•LAND•AILE-0/1/2•ELEV-0/1/2•RUDD-0/1/2 AND GEAR-0/1/2•AUX2-0/1/2•FMOD-0/1/2•BTFL-0/1•TRN-0/1•SPS-0/1				
		EXP		L	1	2	3	H		
		OFF•ON	IN	0					100	
			OUT							
	MIX2	CHANNEL				Pos.0		Pos.1		OFFSET
		→				%	%	%	%	
		INCLUDE:		INCLUDE:		SW: CRUI•SPEE•THRM•LAUN•LAND•AILE-0/1/2•ELEV-0/1/2•RUDD-0/1/2 AND GEAR-0/1/2•AUX2-0/1/2•FMOD-0/1/2•BTFL-0/1•TRN-0/1•SPS-0/1				
		EXP		L	1	2	3	H		
		OFF•ON	IN	0					100	
			OUT							
	MIX3	CHANNEL				Pos.0		Pos.1		OFFSET
		→				%	%	%	%	
		INCLUDE:		INCLUDE:		SW: CRUI•SPEE•THRM•LAUN•LAND•AILE-0/1/2•ELEV-0/1/2•RUDD-0/1/2 AND GEAR-0/1/2•AUX2-0/1/2•FMOD-0/1/2•BTFL-0/1•TRN-0/1•SPS-0/1				
		EXP		L	1	2	3	H		
		OFF•ON	IN	0					100	
			OUT							
	MIX4	CHANNEL				Pos.0		Pos.1		OFFSET
		→				%	%	%	%	
		INCLUDE:		INCLUDE:		SW: CRUI•SPEE•THRM•LAUN•LAND•AILE-0/1/2•ELEV-0/1/2•RUDD-0/1/2 AND GEAR-0/1/2•AUX2-0/1/2•FMOD-0/1/2•BTFL-0/1•TRN-0/1•SPS-0/1				
		EXP		L	1	2	3	H		
		OFF•ON	IN	0					100	
			OUT							
MIX5	CHANNEL				Pos.0		Pos.1		OFFSET	
	→				%	%	%	%		
	INCLUDE:		INCLUDE:		SW: CRUI•SPEE•THRM•LAUN•LAND•AILE-0/1/2•ELEV-0/1/2•RUDD-0/1/2 AND GEAR-0/1/2•AUX2-0/1/2•FMOD-0/1/2•BTFL-0/1•TRN-0/1•SPS-0/1					
	EXP		L	1	2	3	H			
	OFF•ON	IN	0					100		
		OUT								
MIX6	CHANNEL				Pos.0		Pos.1		OFFSET	
	→				%	%	%	%		
	INCLUDE:		INCLUDE:		SW: CRUI•SPEE•THRM•LAUN•LAND•AILE-0/1/2•ELEV-0/1/2•RUDD-0/1/2 AND GEAR-0/1/2•AUX2-0/1/2•FMOD-0/1/2•BTFL-0/1•TRN-0/1•SPS-0/1					
	EXP		L	1	2	3	H			
	OFF•ON	IN	0					100		
		OUT								

DIFFERENTIAL		AILE	RUDD	FLAP	BREAK
	CRUISE	%	%	%	%
	SPEED	%	%	%	%
	THERMAL	%	%	%	%
	LAUNCH	%	%	%	%
	LAND	%	%	%	%

\* Please make a copy for use.



# Data Sheet for Gliders



## XG8 DATA SHEET

**GRID**

TRIM INPUT SW	TRIM	SW SEL
	TIS0	AND CRUI•SPEE•THRM•LAUN•LAND•AILE-0/1/2•ELEV-0/1/2•RUDD-0/1/2 GEAR-0/1/2•AUX2-0/1/2•FMOD-0/1/2•BTFL-0/1•TRN-0/1•SPS-0/1
	TIS1	AND CRUI•SPEE•THRM•LAUN•LAND•AILE-0/1/2•ELEV-0/1/2•RUDD-0/1/2 GEAR-0/1/2•AUX2-0/1/2•FMOD-0/1/2•BTFL-0/1•TRN-0/1•SPS-0/1
	TIS2	AND CRUI•SPEE•THRM•LAUN•LAND•AILE-0/1/2•ELEV-0/1/2•RUDD-0/1/2 GEAR-0/1/2•AUX2-0/1/2•FMOD-0/1/2•BTFL-0/1•TRN-0/1•SPS-0/1
TIS3	AND CRUI•SPEE•THRM•LAUN•LAND•AILE-0/1/2•ELEV-0/1/2•RUDD-0/1/2 GEAR-0/1/2•AUX2-0/1/2•FMOD-0/1/2•BTFL-0/1•TRN-0/1•SPS-0/1	

STICK ALERT	ACT•INH	POS
	CRUI•SPEE•THRM•LAUN•LAND•AILE-0/1/2	
	ON ELEV-0/1/2•RUDD-0/1/2•GEAR-0/1/2•AUX2-0/1/2 FMOD-0/1/2•BTFL-0/1•TRN-0/1•SPS-0/1	

SPOI STICK DIRECTION	REV•NORM
STICK MODE	

ALTITUDE	SOUND 1	m/ft	↑•↓•~	m/ft
	SOUND 2	m/ft	↑•↓•~	m/ft
	SOUND 3	m/ft	↑•↓•~	m/ft
	SW SEL	ON CRUI•SPEE•THRM•LAUN•LAND•AILE-0/1/2 • ELEV-0/1/2•RUDD-0/1/2•GEAR-0/1/2•AUX2-0/1/2 AND FMOD-0/1/2•BTFL-0/1•TRN-0/1•SPS-0/1		

VARIOMETER	SOUND 1	m/s•fps
	SOUND 2	m/s•fps
	SOUND 3	m/s•fps
	SOUND 4	m/s•fps
	SW SEL	ON•AND CRUI•SPEE•THRM•LAUN LAND•AILE-0/1/2•ELEV-0/1/2 RUDD-0/1/2•GEAR-0/1/2 AUX2-0/1/2•FMOD-0/1/2 BTFL-0/1•TRN-0/1•SPS-0/1

TEMPERATURE	ALARM
	INH• ( °C/°F)

RX-BATTERY	ALARM
	INH• ( v)

RPM	GEAR RATIO	PROPELLER	DELAY
	INH• ( )	INH• ( )	INH• ( )

FLIGHT PACK	VOLT-ALARM	CAPACITY	CAPA-ALARM
	INH• ( v)	mAh	INH• ( %)

NO LINK ALARM	INH•
	10s•15s
	20s•30s

\* Please make a copy for use.



## SOFTWARE ERROR SCREENS

### If the Following Messages are Displayed...

- In the situation where errors occur in transmitter software operations, error displays are shown to indicate the internal error details.

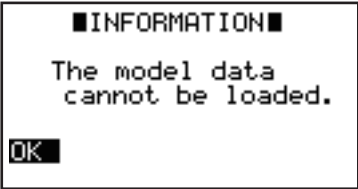
Message Display	Cause	Response
<b>Model Data Reading Failure</b> 	This is displayed in the SD update when the model data is initialized, and when there are internal memory operation problems.	If the message is repeatedly displayed, please contact this company's Service Department.

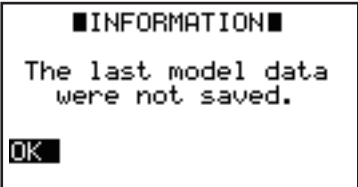
Message Display	Cause	Response
<b>This is displayed when the model setting data has not been normally saved.</b> 	This is displayed if the battery is removed while setting is taking place, and when there are problems in the internal memory.	If the message is repeatedly displayed, please contact this company's Service Department.

## Repairs and After-Sales Service

### ■ Be sure to read the warranty.

Only when the product is faulty after normal operation within the warranty period, we will repair the product for free based on our regulations. The repair will be paid for by the consumer when the damage is due to use in improper ways (i.e., damages due to failure in operation, misuse etc.) or beyond the warranty period, or without the warranty attached (Copies will not be accepted). Note that some damages may not be economically repairable.

The scope of the warranty is limited to the Proportional Radio System and excludes aircrafts, engines and any other non JR product.

Please note beforehand that we will not be responsible for any damage to the data which was set or recorded by the customer/the third person, data loss, damage caused by missing an opportunity of the product use, nor for any compensation for damage to human life, health or property, nor for any damage incidental to the above.

When the warranty period has expired, we will repair the product for cost if requested by the customer and if we judge that the product may be continuously/safely used after repairing.

■ Please note in advance that the warranty period may vary depending on each JR Sales Agent (JR Distributor) in your country. Please contact them for further details concerning the warranty or After-Sales Service (i.e. Repair services, purchase of parts and/or the accessories).

### ■ Preset Data

Please save the preset data on a data sheet or on a SD card, before requesting any repair.

The product may be initialized during the repair as needed. We will not be responsible for any damage or loss of data set by customers.

### ■ Caution ■

1. This product and the associated documents are copyrighted by Japan Remote Control Co., Ltd.  
It is prohibited by law to duplicate, copy, reprint, or modify the product/documents, either entirely or partially without prior notice and approval.
2. This product is not designed to be used as equipment or as an instrument which involves human life including purposes for medical instrument, aerospace instrument, transport equipment, and weapon system, or any other purpose in which high reliability is required, such as space satellite use. We will not be responsible for physical injury, fire, or any other social damage arising from the improper use of this product in any of the equipment or equipment control systems of the general type as described (but not limited to) above.
3. The product and the contents in the document are subject to change without prior notice due to ongoing development.
4. If customers violate any of the terms listed in ■ Caution ■ of this document, customers shall terminate the use of the product if ordered by our company.
5. Please note that regardless of the above, we will not be responsible for any other effects which arise by operating the product.