

6K

8-Channel Digital Proportional R/C System

S.BUS 2™



INSTRUCTION MANUAL

Futaba®

1M23N30308

Digital Proportional R/C System



8 CHANNEL COMPUTER SYSTEM **T6K MANUAL**

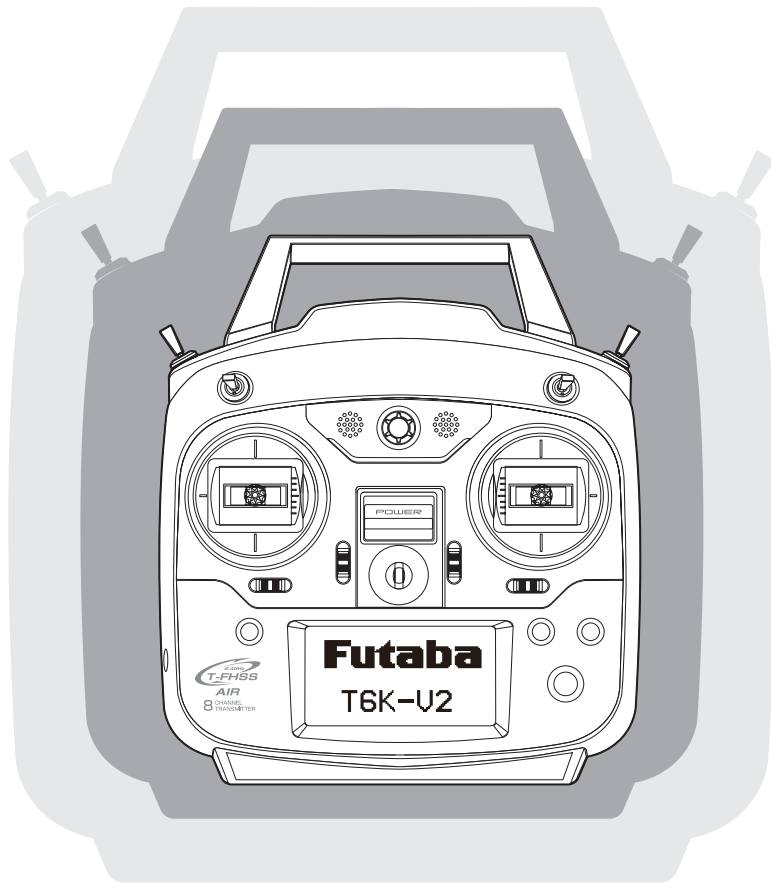

Technical updates and additional programming examples available at: <http://www.futaba-rc.com/faq>
Entire Contents © 2017

TABLE OF CONTENTS

Introduction.....	6
●Support and Service	6
●Application, Export, and Modification....	7
●Definitions of Symbols.....	9
●Precautions (do not operate without reading).....	9
<hr/>	
Before use.....	13
●Features	13
●Contents and technical specifications ...	14
●System compatibilty	14
●Accessories.....	15
●Transmitter controls.....	16
●Battery	18
●How to turn transmitter power ON/OFF .	22
●Adjusting display contrast	22
●Transmitter displays & buttons	23
●Keys lock	24
●Stick control	24
Stick control : Airplane Example	25
Stick control : Helicopter Example	26
Stick control : Multicopter Example	27
●Digital trims	28
●Connector/Plug	29
●Switch assignment table	30
●Receiver and servo connections.....	31
●Adjusting the length of the control sticks..	34
●Stick lever tension adjustment.....	34
●Warning & error displays.....	35
●Link procedure	36
●R3006SB Installtion.....	38
●R3006SB CH mode	39
●R2001SB/R3001SB Installtion.....	40
●R3001SB CH mode	41
●Receiver's antenna installation.....	42

INTRODUCTION

BEFORE USE



COMMON



AIRPLANE



HELICOPTER



GLIDER



MULTICOPTER



TX SETTING

●Mounting the servo.....	43	Telemetry unit.....	68
●Mounting the power switch	43	Speech language	68
●Range check the radio	44	Speech volume	69
●S.BUS/S.BUS2 Installation	45	Stick position alarm	69
●S.BUS Wiring example.....	46	●Program mixing.....	70
●S.BUS2 System.....	47	●AUX channel	73
●S.BUS/S.BUS2 Device setting	48	●Servo monitor / Servo test.....	74
●Telemetry System.....	49	●Telemetry.....	75
<hr/>		Telemetry:Rx-batt	75
Common function.....	50	Telemetry:Ext-volt	79
●Model select.....	52	Optional telemetry sensors.....	83
Model select	53	Telemetry:temp.....	84
RX type (T-FHSS Air ⇔ S-FHSS)	53	Telemetry:rpm.....	85
Link	53	Telemetry:altitude	86
Date reset.....	54	Telemetry:vario	87
Model copy.....	54	Telemetry:current	88
●Model type.....	55	Telemetry:voltage.....	89
Model type	56	Telemetry:capacity	90
Wing type	56	●Sensor.....	91
Tail type.....	56	Sensor:register.....	92
Swash type	56	●S.BUS servo link	93
●Model name.....	57	●Model transfer.....	96
Model name	57	●Timer.....	97
User name	58	●Trainer	100
●Fail safe.....	59	<hr/>	
●End point	61	Airplane function	102
●Trim.....	62	●Throttle cut.....	104
●Sub trim	63	●Dual rate / EXPO.....	106
●Servo reverse.....	64	●Throttle curve	108
●Parameter	65	●Idle down	109
LCD contrast	66	●Gyro sensor	110
Back light	67	●Aileron Differential.....	111
Light time.....	67	●V-Tail.....	112
Light adjustment.....	67	●Camber	113
Battery alarm voltage	67	●Air brake	114
Battery alarm voltage vibration	67	●Elevator→Flap mixing.....	116
Buzzer tone	67	●Flap→Elevator mixing.....	117
Home display	68	●Elevon	118
Telemetry mode	68		

Helicopter function	119
•Condition	121
•Throttle cut.....	122
•Dual rate / EXPO.....	124
•Trim offset	126
•Delay	127
•Gyro sensor	128
•Swash AFR	129
•Swash mixing	130
•Throttle curve	132
•Pitch curve.....	134
•Revolution mixing (PIT to RUD)	136
•Throttle hold	138
•Hovering throttle	139
•Hovering pitch	140

Glider function	141
•Condition	143
•Dual rate / EXPO.....	144
•Motor switch	146
•Gyro sensor	147
•Aileron Differential.....	148
•V-tail.....	149
•Butterfly mixing	150
•Trim mix	151
•Elevator→Camber mixing.....	152
•Camber mixing	154
•Aileron→Camber mixing.....	155

Multicopter function	156
•Flight mode.....	158
•Center alarm	160
•Dual rate / EXPO.....	161
•Throttle curve	163
•Throttle delay	164

•Gyro sensor	165
--------------------	-----

TX setting.....	166
•Stick-mode.....	166
•Stick-adjustment.....	166
•Throttle stick reverse.....	167
•Language	167

INTRODUCTION

Thank you for purchasing a Futaba® T-FHSS Air-2.4GHz 6K series digital proportional R/C system. This system is extremely versatile and may be used by beginners and pros alike. In order for you to make the best use of your system and to fly safely, please read this manual carefully. If you have any difficulties while using your system, please consult the manual, our online Frequently Asked Questions (on the web pages referenced below), your hobby dealer, or the Futaba Service Center.

Due to unforeseen changes in production procedures, the information contained in this manual is subject to change without notice.

Support and Service: It is recommended to have your Futaba equipment serviced annually during your hobby's "off season" to ensure safe operation.

IN NORTH AMERICA

Please feel free to contact the Futaba Service Center for assistance in operation, use and programming. Please be sure to regularly visit the 6K Frequently Asked Questions web site at www.futaba-rc.com/faq/. This page includes extensive programming, use, set up and safety information on the 6K radio system and is updated regularly. Any technical updates and US manual corrections will be available on this web page. If you do not find the answers to your questions there, please see the end of our F.A.Q. area for information on contacting us via email for the most rapid and convenient response.

Don't have Internet access? Internet access is available at no charge at most public libraries, schools, and other public resources. We find internet support to be a fabulous reference for many modelers as items can be printed and saved for future reference, and can be accessed at any hour of the day, night, weekend or holiday. If you do not wish to access the internet for information, however, don't worry. Our support teams are available Monday through Friday 8-5 Central time to assist you.

FOR SERVICE ONLY:

Futaba Service Center
3002 N. Apollo Drive, Suite 1
Champaign, IL 61822
Phone: 217-398-0007
www.futaba-rc.com/service.html
Email: futabaservice@hobbico.com

FOR SUPPORT : (PROGRAMMING AND USER QUESTIONS)

Please start here for answers to most questions:
www.futaba-rc.com/faq/
Fax: 217-398-7721
Phone: 217-398-8970 option 2

OUTSIDE NORTH AMERICA

Please contact your Futaba importer in your region of the world to assist you with any questions, problems or service needs.

Please recognize that all information in this manual, and all support availability, is based upon the systems sold in North America only. Products purchased elsewhere may vary. Always contact your region's support center for assistance.

Application, Export, and Modification

1. This product may be used for model airplane or surface (boat, car, robot) use. It is not intended for use in any application other than the control of models for hobby and recreational purposes. The product is subject to regulations of the Ministry of Radio/Telecommunications and is restricted under Japanese law to such purposes.

2. Exportation precautions:

(a) When this product is exported from the country of manufacture, its use is to be approved by the laws governing the country of destination which govern devices that emit radio frequencies. If this product is then re-exported to other countries, it may be subject to restrictions on such export. Prior approval of the appropriate government authorities may be required. If you have purchased this product from an exporter outside your country, and not the authorized Futaba distributor in your country, please contact the seller immediately to determine if such export regulations have been met.

(b) Use of this product with other than models may be restricted by Export and Trade Control Regulations, and an application for export approval must be submitted. This equipment must not be utilized to operate equipment other than radio controlled models.

3. Modification, adjustment, and replacement of parts: Futaba is not responsible for unauthorized modification, adjustment, and replacement of parts on this product. Any such changes may void the warranty.

Compliance Information Statement (for U.S.A.)

This device trade name Futaba Corporation, complies with part 15 of the FCC Rules. Operation is subject to the following two conditions:

(1) This device may not cause harmful interference, and

(2) This device must accept any interference received, including interference that may cause undesired operation.

(3) This module meets the requirements for a mobile device that may be used at separation distances of more than 20cm from human body.

To meet the RF exposure requirements of the FCC this device shall not be co-located with another transmitting device.

The responsible party of this device compliance is:

Futaba Service Center

3002 N Apollo Drive Suite 1, Champaign, IL 61822 U.S.A.

TEL (217)398-8970 or E-mail: support@hobbico.com (Support)

TEL (217)398-0007 or E-mail: futabaservice@hobbico.com (Service)



The RBRC. SEAL on the nickel-cadmium battery contained in Futaba products indicates that Futaba Corporation is voluntarily participating in an industry-wide program to collect and recycle these batteries at the end of their useful lives, when taken out of service within the United States. The RBRC. program provides a convenient alternative to placing used nickel-cadmium batteries into the trash or municipal waste system, which is illegal in some areas.

(for USA)

You may contact your local recycling center for information on where to return the spent battery. Please call 1-800-8BATTERY for information on NiCd battery recycling in your area. Futaba Corporation involvement in this program is part of its commitment to protecting our environment and conserving natural resources.

*RBRC is a trademark of the Rechargeable Battery Recycling Corporation.

Federal Communications Commission Interference Statement (for U.S.A.)

This equipment has been tested and found to comply with the limits for a Class B digital device, pursuant to Part 15 of the FCC Rules. These limits are designed to provide reasonable protection against harmful interference in a residential installation.

This equipment generates, uses and can radiate radio frequency energy and, if not installed and used in accordance with the instructions, may cause harmful interference to radio communications. However, there is no guarantee that interference will not occur in a particular installation. If this equipment does cause harmful interference to radio or television reception, which can be determined by turning the equipment off and on, the user is encouraged to try to correct the interference by one or more of the following measures:

- Reorient or relocate the receiving antenna.
- Increase the separation between the equipment and receiver.
- Consult the dealer or your Futaba Service center for help.

CAUTION:

To assure continued FCC compliance:

Any changes or modifications not expressly approved by the grantee of this device could void the user's authority to operate the equipment.

Exposure to Radio Frequency Radiation

To comply with FCC RF exposure compliance requirements, a separation distance of at least 20cm must be maintained between the antenna of this device and all persons.

This device must not be co-located or operating in conjunction with any other antenna or transmitter.

Where to Fly

We recommend that you fly at a recognized model airplane flying field. You can find model clubs and fields by asking your nearest hobby dealer, or in the US by contacting the Academy of Model Aeronautics.

You can also contact the national Academy of Model Aeronautics (AMA), which has more than 2,500 chartered clubs across the country. Through any one of them, instructor training programs and insured newcomer training are available. Contact the AMA at the address or toll-free phone number below.

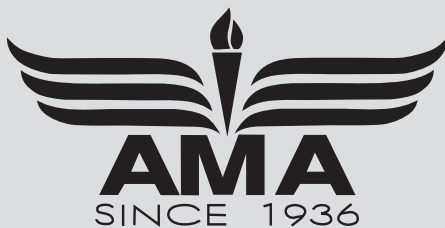

Academy of Model Aeronautics

5161 East Memorial Drive

Muncie, IN 47302

Tele. (800) 435-9262

Fax (765) 289-4248

or via the Internet at <http://www.modelaircraft.org>

Always pay particular attention to the flying field's rules, as well as the presence and location of spectators, the wind direction, and any obstacles on the field. Be very careful flying in areas near power lines, tall buildings, or communication facilities as there may be radio interference in their vicinity.

Precautions

Application, Export, and Modification Precautions.

1. This product is only designed for use with radio control models. Use of the product described in this instruction manual is limited to radio control models.
2. Export precautions:
 - a) When this product is exported, it cannot be used where prohibited by the laws governing radio waves of the destination country.
 - b) Use of this product with other than models may be restricted by Export and Trade Control Regulations.
3. Modification, adjustment, and parts replacement

Futaba is not responsible for unauthorized modification, adjustment, or replacement of parts on this product.

 - No part of this manual may be reproduced in any form without prior permission.
 - The contents of this manual are subject to change without prior notice.
 - The contents of this manual should be complete, but if there are any unclear or missing parts please contact a Futaba Service Center.
 - Futaba is not responsible for the use of this product by the customer.
 - Company and product names in this manual are trademarks or registered trademarks of the respective company.

For safe use

Please observe the following precautions to ensure safe use of this product at all times.

Meaning of Special Markings:

The parts of this manual indicated by the following marks require special attention from the standpoint of safety.

- ⚠ DANGER** - Procedures which may lead to dangerous conditions and cause death/serious injury if not carried out properly.
- ⚠ WARNING** - Procedures which may lead to a dangerous condition or cause death or serious injury to the user if not carried out properly, or procedures where the probability of superficial injury or physical damage is high.
- ⚠ CAUTION** - Procedures where the possibility of serious injury to the user is small, but there is a danger of injury, or physical damage, if not carried out properly.

⊘ = Prohibited ⚠ = Mandatory

WARNING: Always keep electrical components away from small children.

Flying Precautions

⚠ WARNING

⊘ **Never grasp the transmitter built-in antenna part while flying.**

■ The transmitter output may drop drastically.

⊘ **Always make sure that all transmitter stick movements operate all servos properly in the model prior to flight. Also, make sure that all switches, etc. function properly as well. If there are any difficulties, do not use the system until all inputs are functioning properly.**

⊘ **Never fly in the range check mode.**

■ In the dedicated range test range check mode, the transmitter output range is reduced and may cause a crash.

⊘ **While operating, never touch the transmitter with, or bring the transmitter near, another transmitter, a cellphone, or other wireless devices.**

■ Doing so may cause erroneous operation.

⊘ **Never fly on a rainy day, when the wind is strong, and at night.**

■ Water could lead to failure or improper functionality and poor control of the aircraft which could lead to a crash.

⊘ **Never turn the power switch on and off during flight or while the engine or motor is running.**

■ Operation will become impossible and the aircraft will crash. Even if the power switch is turned on, operation will not begin until transmitter and receiver internal processing is complete.

⊘ **Do not start the engine or motor while wearing the neck strap.**

■ The neck strap may become entangled with the rotating propeller, rotor, etc. and cause a serious injury.

⊘ **Do not fly when you are physically impaired as it could pose a safety hazard to yourself or others.**

⊘ **Do not fly at the following places:**

- Near another radio control flying field.
- Near or above people.
- Near homes, schools, hospitals or other places where people congregate.
- Near high voltage lines, high structures, or communication facilities.

⊘ **When setting the transmitter on the ground during flight preparations, do not stand it upright.** ■ The transmitter may tip over, the sticks may move and the propeller or rotor may rotate unexpectedly and cause injury.

⊘ **Do not touch the engine, motor, or FET amp during and immediately after use.**

■ These items may become hot during use.

ⓘ **For safety, fly so that the aircraft is visible at all times.**

■ Flying behind buildings or other large structures will not only cause you to lose sight of the aircraft, but also degrade the RF link performance and cause loss of control.

ⓘ **From the standpoint of safety, always set the fail safe function.**

■ In particular, normally set the throttle channel to idle. For a helicopter, set the throttle channel to maintain a hover.

ⓘ **When flying, always return the transmitter set-up screen to the Home screen.**

■ Erroneous input during flight is extremely dangerous.

ⓘ **Always check the remaining capacity of the transmitter and receiver batteries before each flying session prior to flight.**

■ Low battery capacity will cause loss of control and a crash.

ⓘ **Always check operation of each control surface and perform a range test before each flying session. Also, when using the trainer function, check the operation of both the teacher and student transmitter.**

■ Even one transmitter setting or aircraft abnormality cause a crash.

ⓘ **Before turning on the transmitter:**

1. **Always move the transmitter throttle stick position to the minimum (idle) position.**

2. **Turn on the transmitter first and then the receiver.**

ⓘ **When turning off the transmitter's power switch. After the engine or motor has stopped (state in which it will not rotate again):**

1. **Turn off the receiver power switch.**

2. **Then turn off the transmitter power switch.**

■ If the power switch is turned on/off in the opposite order, the propeller may rotate unexpectedly and cause a serious injury.

■ Also always observe the above order when setting the fail safe function.

■ Maximum low throttle: Direction in which the engine or motor runs at the slowest speed or stops.

ⓘ **When adjusting the transmitter, stop the engine except when necessary. In the case of a motor, disconnect the wiring and to allow it to continue operation. When doing so, please exercise extreme caution. Ensure that the aircraft is secured and that it will not come into contact with anything or anyone. Ensure that the motor will not rotate prior to making any adjustments.**

■ Unexpected high speed rotation of the engine may cause a serious injury.

Battery and Charger Handling Precautions

⚠ DANGER

- ⊘ **Do not recharge a battery that is damaged, deteriorated, leaking electrolyte, or wet.**
- ⊘ **Do not use the charger in applications other than as intended.**
- ⊘ **Do not allow the charger or battery to become wet.**
 - Do not use the charger, when it or your hands, are wet. Do not use the charger in humid places.
- ⊘ **Do not short circuit the battery.**
- ⊘ **Do not solder or repair, deform, modify, or disassemble the battery and/or battery charger.**
- ⊘ **Do not drop the battery into a fire or bring it near a fire.**
- ⊘ **Do not charge and store the battery in direct sunlight or other hot places.**
- ⊘ **Do not charge the battery if it is covered with any object as it may become very hot.**
- ⊘ **Do not use the battery in a combustible environment.**
 - The gas ignite and cause an explosion or fire.
- ⚠ **Always charge the battery before each flying session.**
 - If the battery goes dead during flight, the aircraft will crash.

⚠ WARNING

- ⊘ **Do not touch the charger and battery for any length of time during charging.**
 - Doing so may result burns.
- ⊘ **Do not use a charger or battery that has been damaged.**
- ⊘ **Do not touch any of the internal components of the charger.**
 - Doing so may cause electric shock or a burn.
- ⊘ **If any abnormalities such as smoke or discoloration are noted with either the charger or the battery, remove the battery from the transmitter or charger and disconnect the power cord plug and do not use the charger.**
 - Continued use may cause fire, combustion, generation of heat, or rupture.
- ⊘ **Do not subject the batteries to impact.**
 - Doing so may cause fire, combustion, generation of heat, rupture, or liquid leakage.
- ⊘ **Do not repeatedly charge a nickel-hydrogen battery in the shallow discharge state.**

⚠ Charge the nickel-hydride battery with the dedicated charger supplied with the set.

- Charging the battery past the specified value may cause a fire, combustion, rupture, or liquid leakage. When quick charging, do not charge the battery above 1C.
- Do not charge the battery while riding in a vehicle. Vibration will prevent normal charging.

⚠ When using the optional LiFe battery, disconnect the battery from the transmitter and charge it with the special LBC-4E5 LiFe Battery Charger sold separately.

⊘ When using the optional LiFe battery, do not connect the charger to the balance charge connector and the power connector at the same time.

- Doing so cause a fire, combustion, generation of heat, rupture, or liquid leakage.

⚠ Insert the power cord plug firmly into the receptacle up to its base.

⚠ Always use the charger with the specified power supply voltage.

- Use the special charger by connecting it to a proper power outlet.

⚠ If the battery should get in your eyes, do not rub your eyes, but immediately wash them with tap water or other clean water and get treated by a doctor.

- The liquid can cause blindness.

- The battery memory effect will substantially shorten the battery life even if it is recharged.

⚠ Use and store the battery and battery charger in a secure location away from children.

- Doing so may cause electric shock or injury.

⚠ If the battery leaks liquid or generates an abnormal odor, immediately move it to a safe place for disposal.

- Not doing so may cause combustion.

⚠ If the battery liquid gets on your skin or clothing, immediately flush the area with tap water or other clean water.

- Consult a doctor. The liquid can cause skin damage.

⚠ After the specified charging time has elapsed, end charging and disconnect the charger from the receptacle.

⚠ When recycling or disposing of the battery, isolate the terminals by covering them with cellophane tape.

- Short circuit of the terminals may cause combustion, generation of heat or rupture.

⚠ CAUTION

⊘ **Do not use the nickel-hydrate battery with devices other than the corresponding transmitter.**

⊘ **Do not place heavy objects on top of the battery or charger. Also, do not place the battery or charger in any location where it fall.**

■ Doing so may cause damage or injury.

⊘ **Do not store or use the battery and charger where it is dusty or humid.**

■ Insert the power cord plug into the receptacle only after eliminating the dust.

⊘ **After the transmitter has been used for a long time, the battery may become hot. Immediately remove from the transmitter.**

■ Not doing so may cause a burn.

⊘ **Do not charge the battery in extreme temperatures.**

■ Doing so will degrade the battery performance. An ambient temperature of 10°C to 30°C (50 °F to 86 °F) is ideal for charging.

⚠ **Unplug the charger when not in use.**

⊘ **Do not bend or pull the cord unreasonably and do not place heavy objects on the cord.**

■ The power cord may be damaged and cause combustion, generation of heat, or electric shock.

Storage and Disposal Precautions

⚠ WARNING

⊘ **Keep wireless equipment, batteries, aircraft, etc. away from children.**

⚠ CAUTION

⊘ **Do not store wireless devices in the following places:**

- Where it is extremely hot (40°C [104F] or higher) or cold (-10°C [14F] or lower)
- Where the equipment will be exposed to direct sunlight
- Where the humidity is high
- Where vibration is prevalent
- Where it is very dusty
- Where the device may be exposed to steam and heat

⚠ **When the device will not be used for a long time, remove the battery from the transmitter and aircraft and store them in a dry place where the temperature is between 0 and 30°C [32F and 86F].**

■ Left standing 'as is' may will cause battery deterioration, liquid leakage, etc.

Other Precautions

⚠ CAUTION

⊘ **Do not directly expose plastic parts to fuel, oil, exhaust gas, etc.**

■ If left in such an environment, the plastic may be attacked and damaged.

■ Since the metal parts of the case may corrode, always keep them clean.

⚠ **Join the Academy of Model Aeronautics.**

■ The Academy of Model Aeronautics (AMA) provides guidelines and liability protection should the need arise.

⚠ **Always use genuine Futaba products such as transmitter, receiver, servo, FET amplifier, battery, etc.**

■ Futaba is not responsible for damage sustained by combination with other than Futaba Genuine Parts. Use the parts specified in the instruction manual and catalog.

BEFORE USE

FEATURES

- **T-FHSS Air-2.4GHz / S-FHSS-2.4GHz multi-function 8-channel transmitter**

The Futaba 2.4GHz T-FHSS Air system / S-FHSS system is employed.

- **Telemetry system (It can't be used in case of S-FHSS.)**

A T-FHSS Air bidirectional communication system is used. The voltage of the battery mounted in the fuselage can be displayed at the transmitter during flight. Altitude, temperature, R.P.M, current and voltage data can be displayed at the transmitter by installing various optional telemetry sensors in the fuselage.

- **Speech function (T-FHSS only)**

Telemetry data can be listened to by plugging commercial earphones into the transmitter.

- **Built-in antenna**

Antenna built into the transmitter provides a simple appearance and improves handling ease.

- **S.BUS/S.BUS2 servo setting function**

S.BUS/S.BUS2 servo channel and various functions can be set by connecting the servo to the transmitter.

- **Power-saving type transmitter**

Four AA's alkaline batteries can be used. The optional HT5F1800B (NiMH 6.0V, 1800mA) or FT2F2100BV2 (lithium-ferrite 6.6V, 2100mA) battery can also be used.

- **Vibration**

A function that notifies the operator of various alarms by vibrating the transmitter can be selected.

- **Unique model memory system**

The transmitter body contains a 30 model memory.

- **Mixing type selection**

Fixed wing, helicopter, and glider mixing type can be selected to match the fuselage. In addition, 6 swash plate types can also be selected for helicopters. Multi-copter selection is also possible.

- **Digital trim**

Rapid trimming during flight is possible. The sound changes at the center of trim. The step size can be arbitrarily changed. The trim position is displayed on the LCD.

- **Lever head length adjustment**

The lever head length can be adjusted. Lever head shape that reduces slip during operation has been adopted.

- **Switch/VR position change and AUX channel function change**

Mixing and other switches and VR can be selected. Since the function of the AUX channels (CH5-CH8) can also be changed, original mixing, in addition to existing mixing, can be created by using the programmable mixing function.

- **Model data transfer function**

Model data can be wirelessly transferred between 6K.

R3006SB receiver *The receiver depend on the type of set.

- **T-FHSS Air system S.BUS compatible**

S.BUS output and conventional channel output are provided. S.BUS and conventional system sharing is possible.

- **Battery fail safe function**

CONTENTS AND TECHNICAL SPECIFICATIONS

Your 6K includes the following components:

(Specifications and ratings are subject to change without notice.)

- T6K transmitter for airplanes or helicopters
- Receiver
- Switch harness

*The set contents depend on the type of set.

Transmitter T6K

(2-stick, 8-channel, T-FHSS Air-2.4G system)

Transmitting frequency: 2.4GHz band

System: T-FHSS Air, S-FHSS, switchable

Power supply: 6.0V Dry battery

Receiver R3006SB

(T-FHSS Air-2.4G system, dual antenna diversity, S.BUS, S.BUS2 system)

Power requirement: 4.8V-7.4V battery or regulated output from ESC, etc. (*1)

Size: 1.7 x 0.98 x 0.35 in. (43.1 x 25.0 x 8.8 mm)

Weight: 0.3 oz. (8.5g)

Battery F/S Voltage: It sets up with a transmitter

(*1) When using ESC's make sure that the regulated output capacity meets your usage application.

(Receiver R2001SB)

(S-FHSS -2.4G system, dual antenna diversity, S.BUS system)

Power requirement: 4.8V-7.4V battery or regulated output from ESC, etc. (*1)

Size: 0.83 x 1.65 x 0.21 in. (21.1 x 41.8 x 5.3 mm)

Weight: 0.15 oz. (4.2g)

Battery F/S Voltage: 3.8V

(*1) When using ESC's make sure that the regulated output capacity meets your usage application.

(Receiver R3001SB)

(T-FHSS Air-2.4G system, dual antenna diversity, S.BUS, S.BUS2 system)

Power requirement: 4.8V-7.4V battery or regulated output from ESC, etc. (*1)

Size: 0.83 x 1.65 x 0.21 in. (21.1 x 41.8 x 5.3 mm)

Weight: 0.15 oz. (4.2g)

Battery F/S Voltage: 3.8V

(*1) When using ESC's make sure that the regulated output capacity meets your usage application.

SYSTEM COMPATIBILITY

The **6K** is a **2.4GHz T-FHSS Air system**. The transmitter can also be switched to **S-FHSS**. (However, the telemetry system cannot be used with S-FHSS.) The usable receivers are shown below.

Communications System	Usable Receivers
T-FHSS Air	R3006SB, R3008SB, R3001SB *R304SB, R304SB-E, T-FHSS surface system receivers do not operate.
S-FHSS	R2001SB R2008SB R2006GS R2106GF

NOTE :

*The Futaba **T-FHSS Air** system cannot be used with Futaba **S-FHSS/FASST/FASSTest** systems. Use it with a **T-FHSS Air** system transmitter and receiver. The **T6K** is a **T-FHSS Air system**, but can also be used with an **S-FHSS** receiver by switching to **S-FHSS**. However, in this case the telemetry system cannot be used.

*The **T-FHSS Air system** and **T-FHSS** surface system are different. The **T6K** cannot be used with the **R304SB, R304SB-E** or **T-FHSS** surface system receivers.



The following additional accessories are available from your dealer. Refer to a Futaba catalog for more information:

- HT5F1800B Transmitter battery pack - the (1,800mAh) transmitter NiMH battery pack may be easily exchanged with a fresh one to provide enough capacity for extended flying sessions.
- FT2F2100BV2 Transmitter LiFe battery pack can also be used. However, charge with the charger only for LiFe.
- Trainer cord - the optional training cord may be used to help a beginning pilot learn to fly easily by placing the instructor on a separate transmitter. Note that the T6K transmitter may be connected to another T6K system, as well as to any other models of Futaba transmitters. The T6K transmitter uses one of the three cord plug types according to the transmitter connected. (Refer to the description at the TRAINER function instructions). The part number of this cord is: FUTM4405.
- Servos - there are various kinds of servos. Please choose the Futaba servos best suited for the model and purpose you are using them for. If you utilize a S.BUS system, you should choose a S.BUS servo.
- Telemetry sensor - please purchase an optional sensor, in order to utilize bidirectional communication system and to acquire the information from a model high up in the sky.
 - [Temperature sensor : SBS-01T/TE]
 - [Altitude sensor : SBS-01A/02A]
 - [RPM sensor magnet type : SBS-01RM]
 - [RPM sensor optical type : SBS-01RO]
 - [RPM sensor brushless motor type : SBS-01RB]
 - [Current sensor : SBS-01C]
 - [Voltage sensor : SBS-01V]
- Neckstrap - a neckstrap can be connected to your T6K system to make it easier to handle and improve your flying precision since your hands won't need to support the transmitter's weight.
- Y-harnesses, servo extensions, hub,etc - Genuine Futaba extensions and Y-harnesses, including a heavy-duty version with heavier wire, are available to aid in your larger model and other installations.
- Gyros - a variety of genuine Futaba gyros is available for your aircraft or helicopter needs.
- Receivers - various models of Futaba receivers are may be purchased for use in other models. (Receivers for T-FHSS Air, S-FHSS types are available.)

TRANSMITTER CONTROLS - T6K (in case of mode 2)

Before use

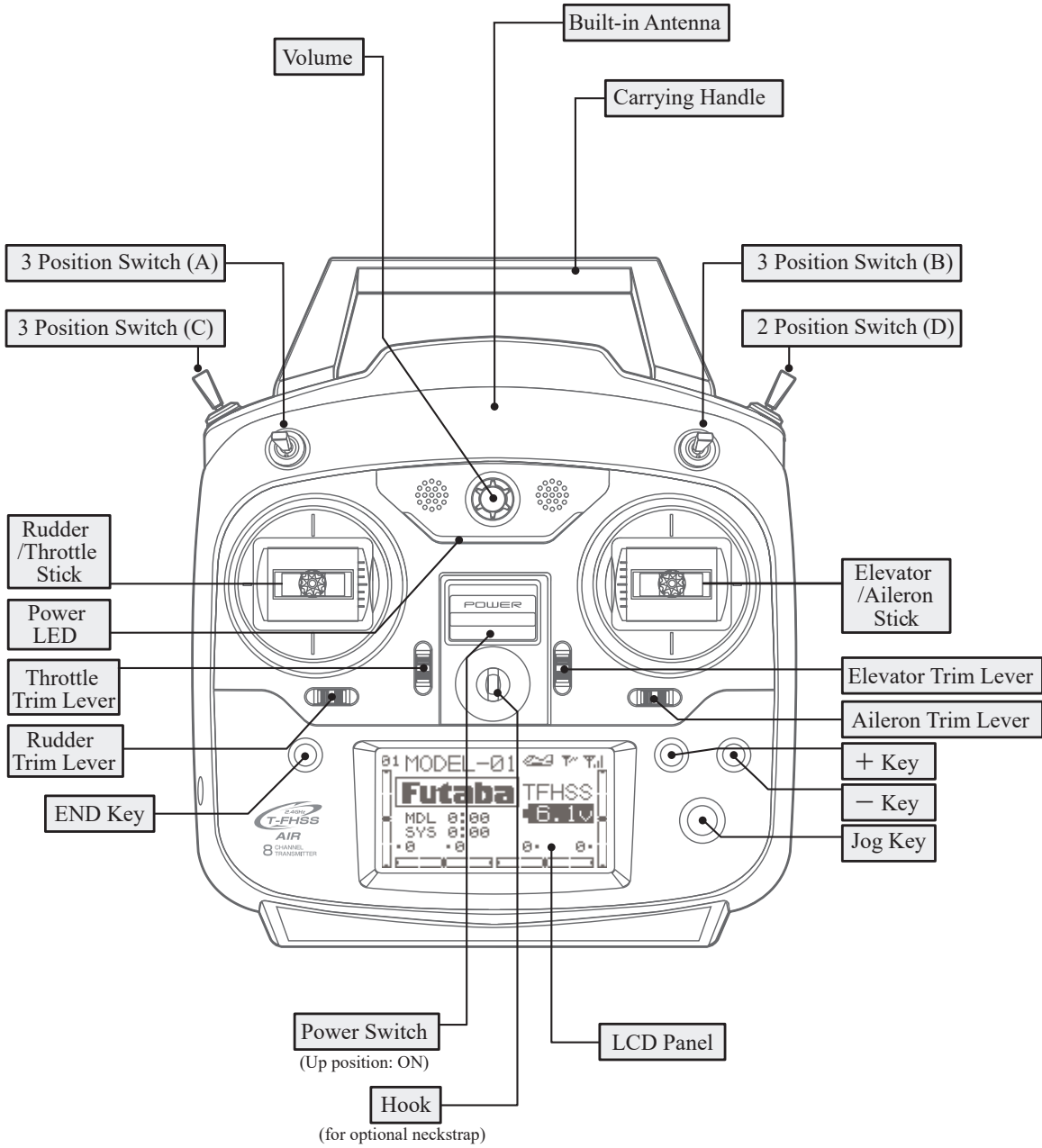

Throttle stick warning

Self neutral type (Multicopter/Robot specification)

A throttle stick returns neutrally by a spring.

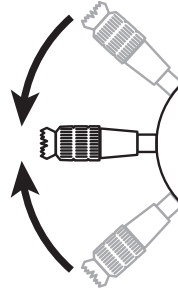

Ratchet type (General transmitter)

A throttle stick doesn't return neutrally.

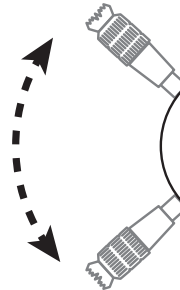

Throttle stick :
Motor or engine
power is controlled.

⚠ WARNING

You cannot use the throttle stick of self-neutral type for RC airplane, RC helicopter, and certain multi-copter.

It's very dangerous if Engine / Motor becomes middle-speed by self-return.

It's necessary to change the stick to the ratchet type if using it for RC airplane and RC helicopter.

INSTALLATION AND REMOVAL OF THE T6K BATTERY

The T6K transmitter is designed to work with either four (4) AA alkaline dry cell batteries, or HT5F1800B battery pack, both available separately. The transmitter batteries used are a matter of personal preference. AA alkaline batteries are available at any local hobby shop, grocery store, etc. A battery pack will need to be purchased from a hobby shop.

Battery Replacement Method

Before use

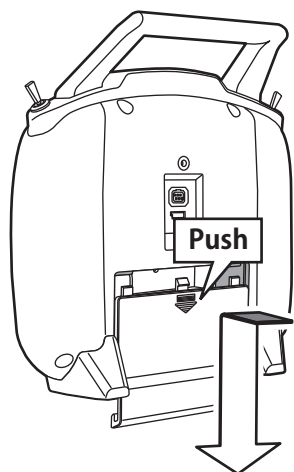

Slide the battery cover off the transmitter in the direction of the arrow in the figure.

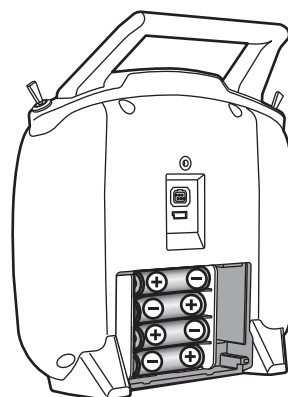
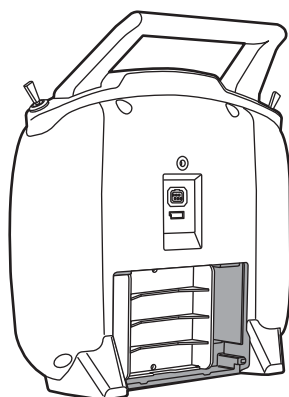

Load the new AA size batteries. Pay very close attention to the polarity markings and reinsert accordingly.

Battery Cover

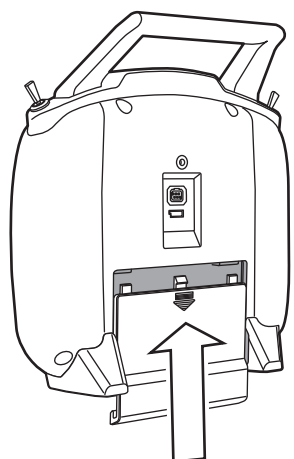
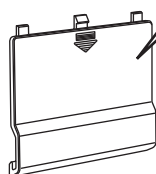

Slide the battery cover back onto the case.

Check:

Turn the power switch on the transmitter to the ON position. Check the battery voltage display on the LCD screen. If the voltage is low, check the batteries for insufficient contact in the case or incorrect battery polarity.

Disposal of the Dry Cell Batteries:

The method to dispose of used dry cell batteries depends on the area in which you reside. Dispose of the batteries in accordance with the regulations for your area.

⚠ CAUTION



Always be sure you reinsert the batteries in the correct polarity order. If the batteries are loaded incorrectly, the transmitter may be damaged.



When the transmitter will not be used for any short or long period of time, always remove the batteries. If the batteries do happen to leak, clean the battery case and contacts thoroughly. Make sure the contacts are free of corrosion.

When Using The Optional Battery HT5F1800B

When using an optional rechargeable battery, replace the battery as described below.

- Always use the optional HT5F1800B rechargeable battery.
- The type of power source used must be set by system setting.
- When the transmitter will not be used for a long time, remove the battery.

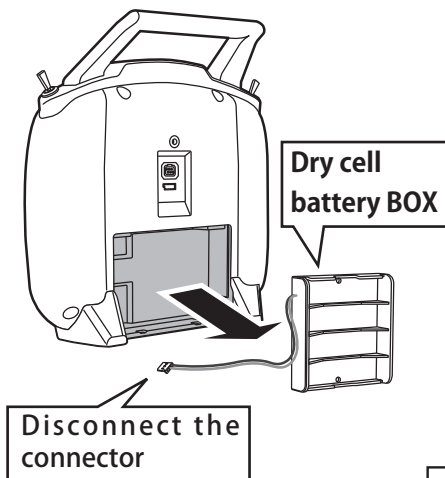

Refer to the previous description and remove the transmitter battery cover. After removing the dry cell battery box from the transmitter, disconnect the connector.

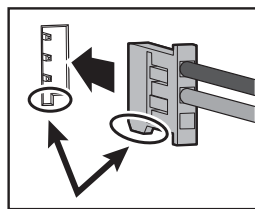
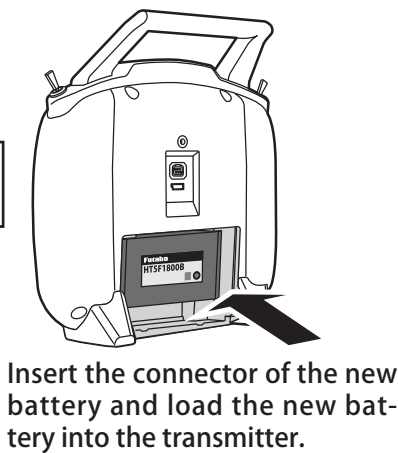

Connect the battery connector.

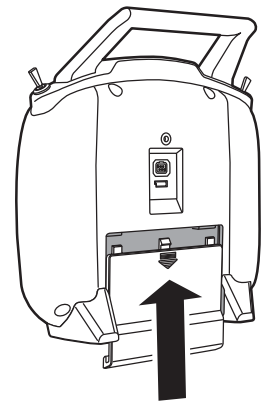

Finish by installing the battery cover.

⚠ CAUTION



When closing the battery cover, be careful that the battery cover does not pinch the battery lead wires.

Shorting of the battery lead wires may lead to fire and abnormal heating and cause burns or fire disaster.

Before use

When Charging the Optional Battery HT5F1800B

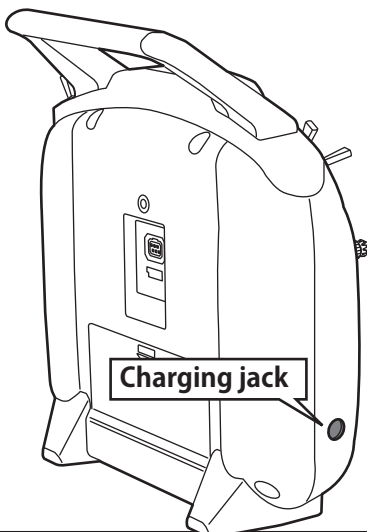

Charging a NiMH Battery

(Example: When using the HT5F1800B with the special charger)

- 1 Plug the transmitter cord of the special charger into the charging jack on the rear of the transmitter.
- 2 Plug the charger into an AC outlet.
- 3 Check that the charging LED lights.

NiMH battery HT5F1800B
(not included)



The charging time when charging the HT5F1800B battery with the optional special charger is approximately 15 hours. However, when the battery has not been used for some time, repeat charging 2 or 3 times to activate the battery.

Over current protection

The transmitter charging circuit is equipped with an over current protection circuit (1.0A). If the battery is charged with a quick charger for other than digital proportional R/C sets, it may not be fully charged.

⚠ CAUTION

- ⊘ Never try to recharge a dry cell battery.
The transmitter may be damaged or the battery electrolyte may leak or the battery may break.
- ⚠ Insert the batteries in the correct polarity.
If the polarity is incorrect, the transmitter may be damaged.
- ⊘ When the transmitter is not in use, remove the batteries.
If the battery electrolyte leaks, wipe off the case and contacts.
- ⊘ Do not use commercial AA size NiCd and NiMH batteries.
Quick charging may cause the battery contacts to overheat and damage the battery holder.

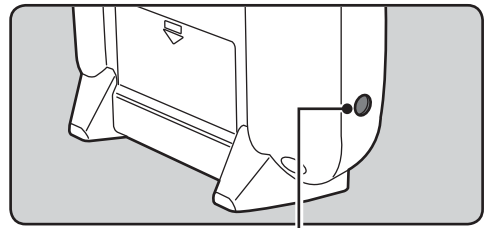
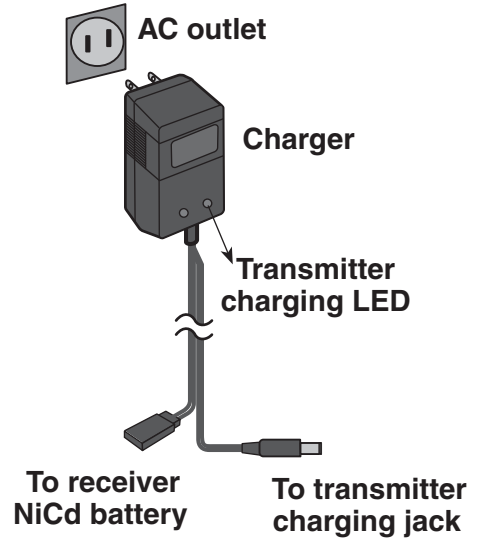

**Charging jack
Cannot be used for
charge of LiFe.**

Charging A LiFe Battery

(Example: When using the FT2F1700BV2/2100BV2 with the special charger)

- 1** Remove the battery cover.
- 2** Disconnect the battery from the T6K.
- 3** Balance charging cannot be done through the transmitter, you must remove the LiFe battery to do this charge.

Charge the optional FT2F1700BV2/2100BV2 (LiFe) battery with the special charger in accordance with the instruction manual supplied.

When the battery will not be used for a long time, to prevent it from deteriorating we recommend that it be kept in about the half capacity state instead of fully charged. Also be careful that the battery does not enter the over-discharged state due to self-discharge. Periodically (about every 3 months) charge the battery.

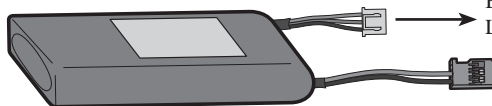

**LiFe battery is removed
from transmitter.**

CHARGING THE BATTERIES *(When the rechargeable battery option is used)*

Charging Your System's Batteries

1. Connect the transmitter charging jack and batteries to the transmitter and receiver connectors of the charger.
2. Plug the charger into a wall socket.
3. Check that the charger LED lights.

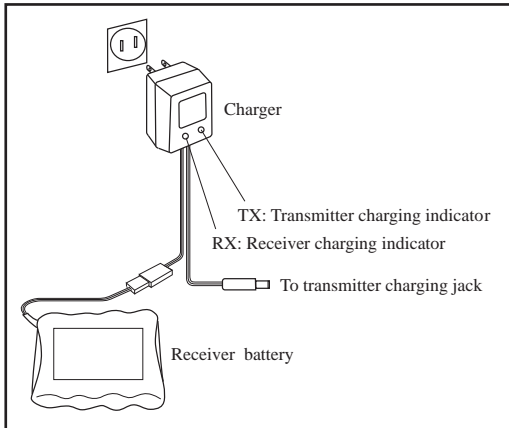

According to the description of the battery to be used and its exclusive charger, please use it after carrying out full charge.

We recommend charging the batteries with the charger supplied with your system. Note that the use of a fast charger may damage the batteries by overheating and dramatically reduce their lifetime.

When HT5F1800B is chosen, HBC-3A (4) is recommended.

When charging FT2F2100BV2, please make sure to remove the battery from the system to charge it. Charger for this battery is recommended to use LBC-4E5.

Before use

Battery Care and Precautions

Below you will find some general rules and guidelines which should be adhered to when charging transmitter and/or receiver battery packs. These are included to serve only as general guidelines, and are not intended to replace or supersede the information provided by the battery and/or charger manufacturer. For complete information, please refer to the instructions that are included with the battery pack(s) and/or chargers that accompany the products purchased.

- Do not allow children to charge battery packs without adult supervision.
- Do not charge battery packs that have been damaged in any way. We strongly suggest frequent inspection of the battery packs to ensure that no damage has occurred.
- Do not allow batteries to overheat! If overheated, disconnect the battery from the charger immediately and allow to cool.
- Do not mix cells- all cells should be of the same material, configuration, etc.
- Do not deep cycle batteries as permanent damage could result.
- Never charge batteries on a surface that may become hot, or may be impacted by the heat.
- Immediately end the charging procedure if either the batteries or charger itself become overly hot.
- NiMH cells do not exhibit the “memory effect” like NiCd cells, so little cycling is needed. Store NiMH packs with some voltage remaining on the cells (refer to battery supplier).
- NiMH cells have a self-discharge rate of approximately 20-25% (compared to 15% for NiCd batteries). It is important to recharge NiMH batteries immediately prior to use.
- Never connect the battery in reverse. Reverse connection will cause the battery to overheat or will damage the inside of the charger.
- Do not add an additional charge after charging.
- Never charge with a current exceeding the nominal capacity (IC) of the rechargeable battery.
- If a battery is charged with a current exceeding 1C, the battery will overheat and deteriorate.
- Do not connect two battery packs or more to one output terminal.
- Avoid extremely cold and hot places and the direct sunlight when you charge batteries.
- It is recommended to perform charging within the 10-30°C (50-86°F) range. Otherwise, it may cause abnormal charging and overheat.

How to turn transmitter power ON/OFF

When turning on the power, the T6K transmitter will begin emitting RF automatically after it confirms the surrounding RF conditions. The status of the transmitter is displayed by LED at the upper part of the front of a T6K.

*If THR stick is high, the next WARNING screen will come out. Moreover, if a power supply is switched on while SW set by WARNING setup has been ON, it will be indicated by WARNING. (In the case of Multicopter mode, throttle position alarm does not occur.)

Power ON

Throttle Stick Low

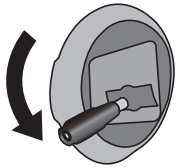

Power Switch

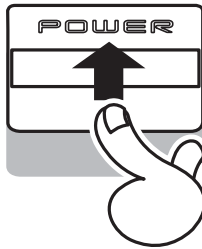

Power OFF

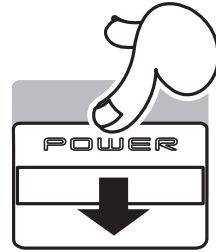

Power Switch

Before use

If the power switches are turned off in the opposite order the model may unexpectedly run out of control and cause a very dangerous situation.

Turning on the power switches

1. Turn on the transmitter power switch.
2. Turn on the receiver or speed control power switch.

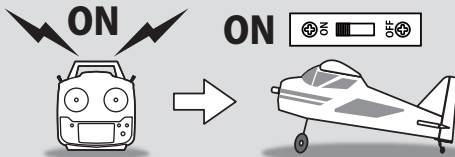

Turning off the power switches

- Always be sure the motor/engine is stopped.
- 1. Turn off the receiver or speed control power switch.
- 2. Then turn off the transmitter power switch.

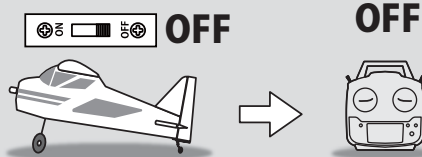

ADJUSTING DISPLAY CONTRAST

To adjust the display contrast, from the home menu press and hold the **END BUTTON**. Push the **+ KEY** while still holding the **END BUTTON**:

- + **KEY** to brighten
- **KEY** to darken the display

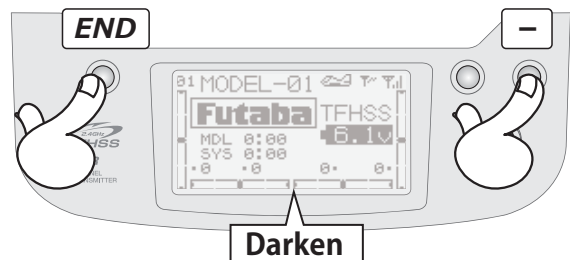
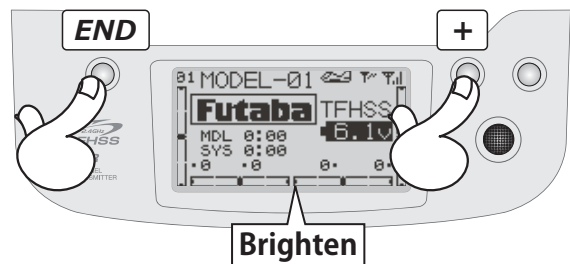

TRANSMITTER DISPLAYS & BUTTONS

When you first turn on your transmitter, a confirmation double beep sounds, and the screen shown below appears. Before flying, or even starting the engine, be sure that the model type and name appearing on the display matches the model that you are about to fly! If you are in the wrong model memory, servos may be reversed, and travels and trims will be wrong, potentially leading to a crash.

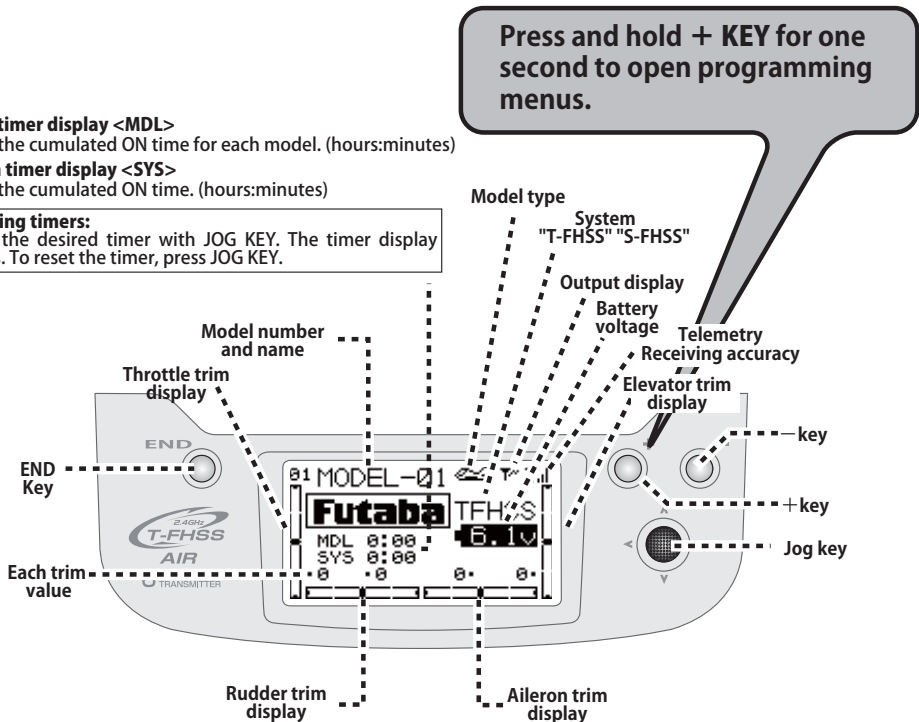

Before use

Edit buttons and Start-up Screen (appears when system is first turned on):

JOG KEY:

Control **JOG KEY** to scroll up/scroll down/scroll left/scroll right and select the option to edit within a function. When the menu has multiple pages, move the **JOG KEY** horizontally (left or right).

Press **JOG KEY** to select the actual function you wish to edit from the menu.

Press **JOG KEY** and hold one second to confirm major decisions, such as the decision to: select a different model from memory, copy one model memory over another, trim reset, store channel position in FailSafe, change model type, reset entire model, condition of a helicopter setup is changed. An on screen inquiry will ask if you are sure.

Press **JOG KEY** again to accept the change.

+ KEY:

Press and hold + **KEY** for one second to open programming menus. It is used for changing a setup, or a numerical increase. Changing the menus pages can also be performed.

- KEY:

It is used for change of a setup, or reduction of a number. Change of the page of a menu can also be performed.

END KEY:

Press END KEY to return to previous screen, close functions back to menus, and close menus to start-up screen.

Keys Lock

To prevent the data from being changed by erroneous touching of the keys during flight, a function which makes the keys impossible temporarily.

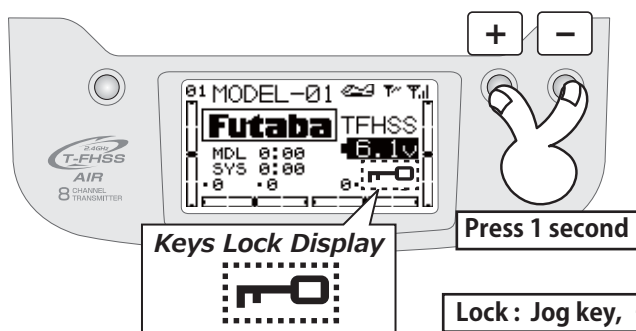

How to lock

- 1 The home screen is displayed.
- 2 Press the + key and - key simultaneously for about 1 second. "Key mark" is displayed and the keys disabled.

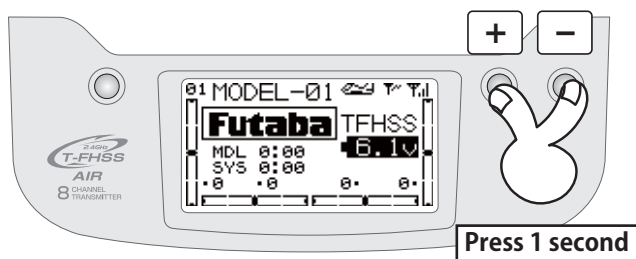

How to unlock

- 1 Press the + key and - key simultaneously for about 1 second in the touch sensor locked state. The keys enabled again.

Stick control

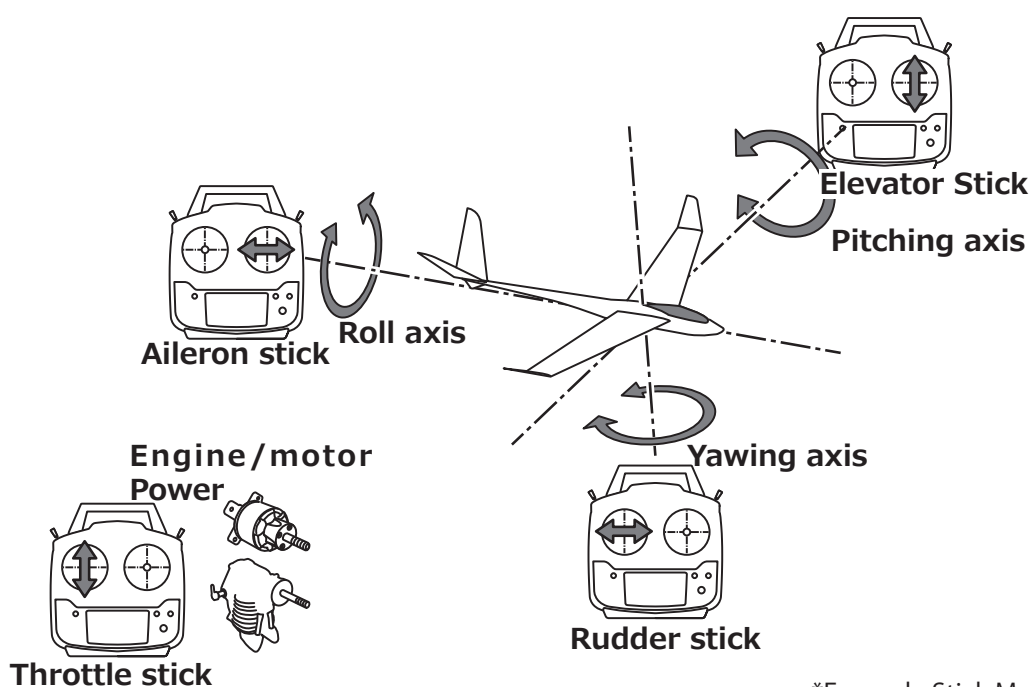

*Example Stick Mode2

Stick control : Airplane Example

*Example Stick Mode2

A general model example. (There is also a different operational model.)

Before use

Roll axis Control

Right roll
The right aileron is up.
The left aileron is down.

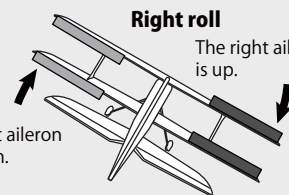

Aileron stick
↓
To the right



Level flight



Neutral



Left roll
The left aileron is up.
The right aileron is down.

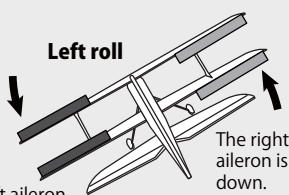

Aileron stick
↓
To the left



Pitch axis Control

Nose Up

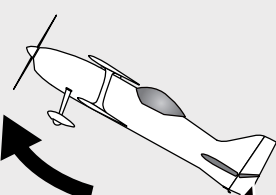

Elevator stick
↓
UP
(moved to the bottom)



Elevator is up.

Level flight

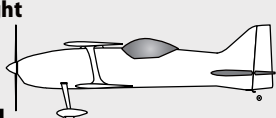

Neutral



Elevator is down.

Nose Down

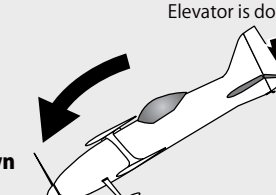

Elevator stick
↓
DOWN
(moved to the top)



Yaw axis Control

Nose Right

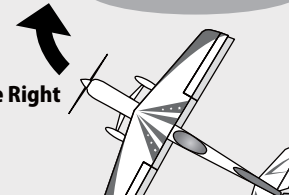

Rudder stick
↓
To the right



The rudder is right.

Straight



Neutral



The rudder is left.

Nose Left

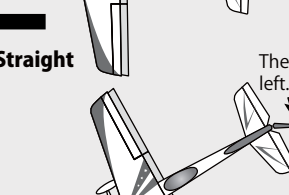

Rudder stick
↓
To the left



Throttle Control

Hight

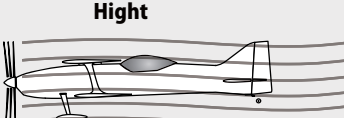

Throttle stick
↓
HIGHT
(moved to the top)



Middle

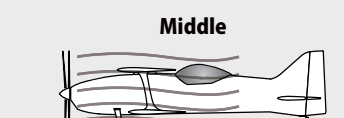

Throttle stick
↓
MIDDLE
(neutral)



Slow



Throttle stick
↓
SLOW
(moved to the bottom)



Stick control : Helicopter Example

*Example Stick Mode2

A general model example. (There is also a different operational model.)

Before use

Roll axis Control

Right roll

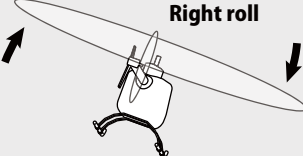

Aileron stick
↓
To the right



Level flight

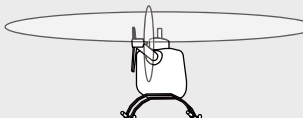

Neutral



Left roll

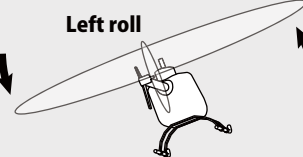

Aileron stick
↓
To the left



Pitch axis Control

Nose Up

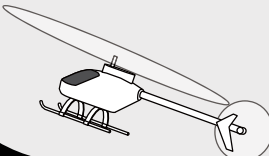

Elevator stick
↓
UP
(moved to the bottom)



Level flight

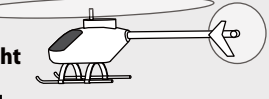

Neutral

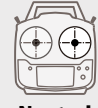

Nose Down

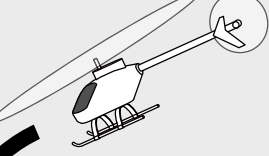

Elevator stick
↓
DOWN
(moved to the top)



Yaw axis Control

Nose Right

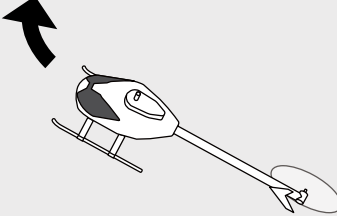

Rudder stick
↓
To the right



Neutral



Straight

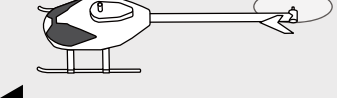

Nose Left

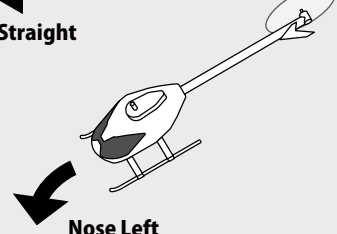

Rudder stick
↓
To the left



Throttle /Pitch Control

Rise

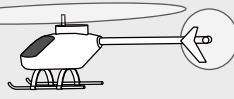

Pitch Up



High



Throttle stick
↓
HIGHT
(moved to the top)



Hovering

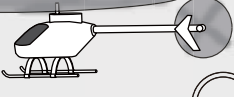

Middle



Throttle stick
↓
MIDDLE
(neutral)

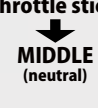

Descent



Pitch Down



Slow



Throttle stick
↓
SLOW
(moved to the bottom)



Stick control : Multicopter Example

*Example Stick Mode2

A general model example. (There is also a different operational model.)

Before use

Roll axis Control

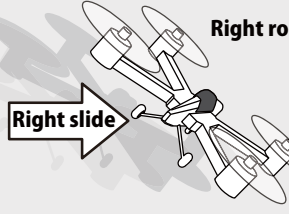
Right roll
 Right slide →  Aileron stick
 ↓
 To the right

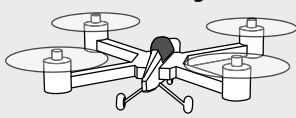
Hovering Level flight
 Neutral

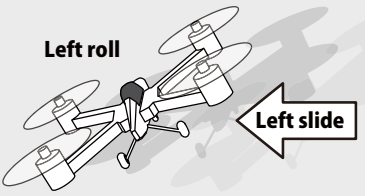
Left roll
 ← Left slide Aileron stick
 ↓
 To the left

Pitch axis Control

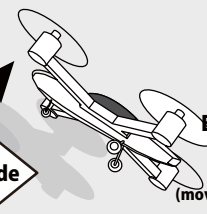
Nose Up
 ↑ Back slide →  Elevator stick
 ↓
 UP (moved to the bottom)

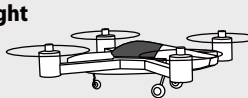
Hovering Level flight
 Neutral

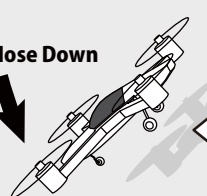
Nose Down
 ↓ Front slide ←  Elevator stick
 ↓
 DOWN (moved to the top)

Yaw axis Control

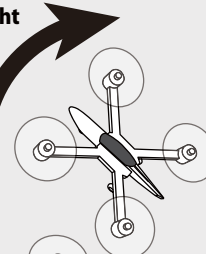
Nose Right
 ↻  Rudder stick
 ↓
 To the right

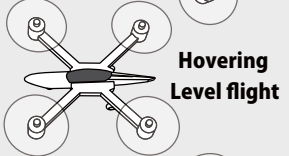
Hovering Level flight
 Neutral

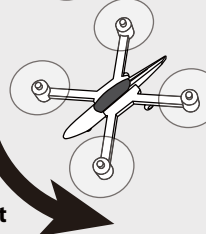
Nose Left
 ↻  Rudder stick
 ↓
 To the left

Throttle Control

Rise
 ↑  Throttle stick
 ↓
 HIGHT (moved to the top)

Hovering
 Throttle stick
 ↓
 MIDDLE (neutral)

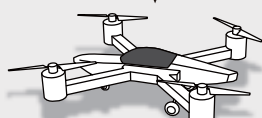
Descent
 ↓  Throttle stick
 ↓
 SLOW (moved to the bottom)

Stop

Digital Trims T1-T4

Before use

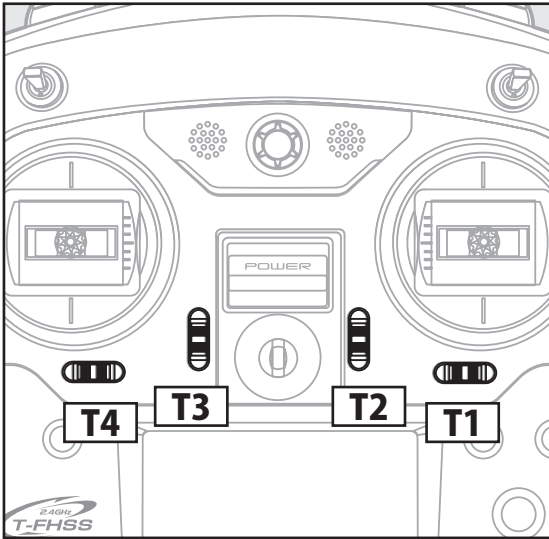

This transmitter is equipped with 4 digital trims. Each time you press a trim button, the trim position moves one step. If you continue pressing it, the trim position starts to move faster. In addition, when the trim position returns to the center, the tone will change. You can always monitor trim positions by referencing the LCD screen.

*You can select the trim step amount and the display unit on the home screen on the T1-T4 setting screen within the linkage menu.

Note: The trim positions you have set will be stored in the non-volatile memory and will remain there.

Digital trim operational example

*Example Stick Mode2

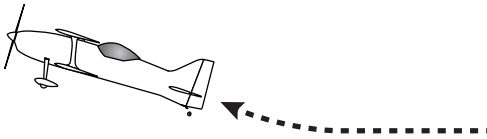

◆When the airplane goes up while the elevator stick is neutral.

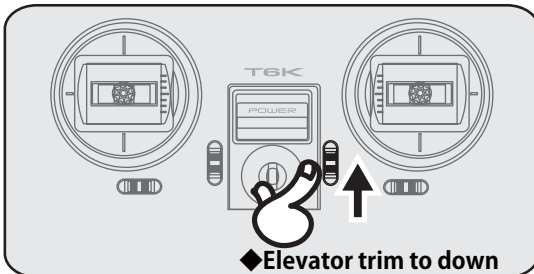

Elevator neutral

Down

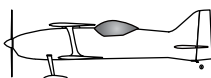
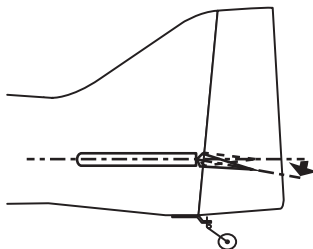

◆When the airplane dives while the elevator stick is neutral.

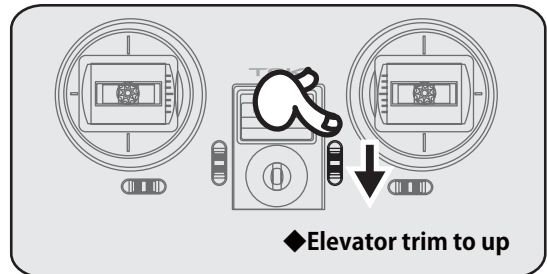

Elevator neutral

Up

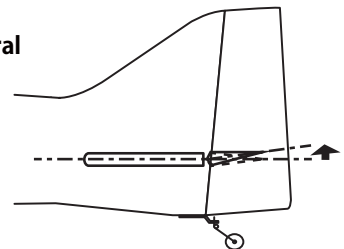

◆Adjust so that the airplane flies level.

CONNECTOR / PLUG

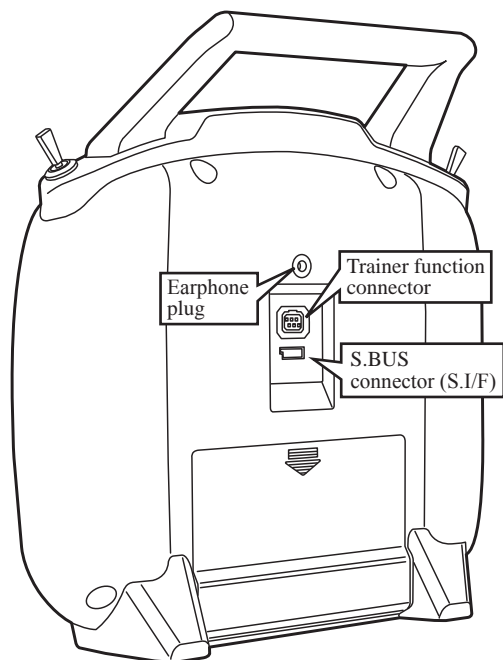

Earphone plug

The telemetry data can be listened to by plugging in commercial 3.5mm earphones. (See the telemetry item for the detailed setting.)

Trainer function connector

When you use the trainer function, connect the optional trainer cable between the transmitters for teacher and student.

*You can set the trainer function on the Trainer Function screen.

S.BUS connector (S.I/F)

When setting an S.BUS servo and telemetry sensor, connect them both here.

(Supply power by 3-way hub or 2-way cord.)

Before use

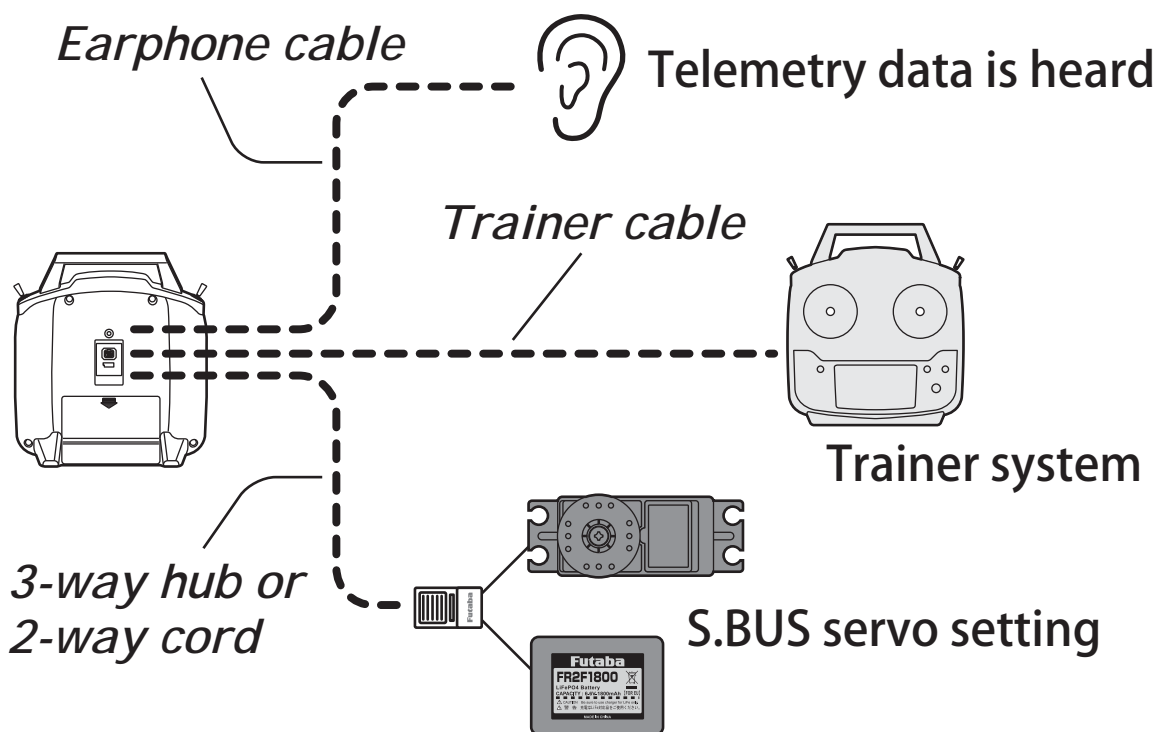

SWITCH ASSIGNMENT TABLE

- The factory default functions activated by the switches and VR for an 6K transmitter are shown below.
- Most 6K functions may be reassigned to non-default positions quickly and easily.
- Basic control assignments of channels 5-8 are quickly adjustable in AUX-CH.
- Note that most functions need to be activated in the programming to operate.

AIRPLANE

Switch/VR	1AIL	1AIL1FLP	2AIL	2AIL1FLP	ELEVON
Switch A	---	---	---	---	---
Switch B	CH6	CH6	---	---	CH6
Switch C	CH5	CH5	CH5	CH5	CH5
Switch D	---	---	---	---	---
VR	---	---	---	---	---

GLIDER

Switch/VR	1AIL	1AIL1FLP	2AIL	2AIL1FLP	2AIL2FLP
Switch A	---	---	---	---	---
Switch B	CH6	---	---	---	---
Switch C	---	---	---	---	---
Switch D	---	---	---	---	---
VR	CH5	Flap	CH5	Flap	Flap

HELICOPTER

Switch/VR	HELICOPTER
Switch A	---
Switch B	CH5
Switch C	IDLE-UP1/2
Switch D	THR-HOLD
VR	---

*When idle-up 1/2 and a throttle hold were used.

MULTI COPT

Switch/VR	MULTI COPT
Switch A	---
Switch B	---
Switch C	---
Switch D	CH5
VR	---

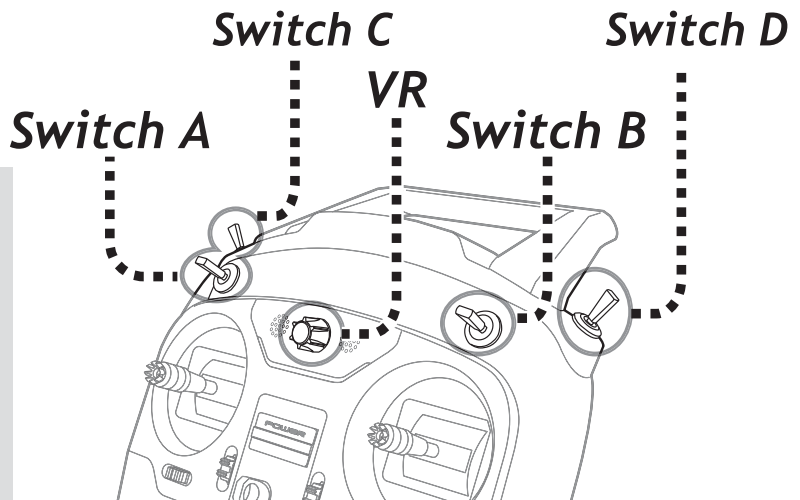

⚠ Remember that if you assign primary control of a channel to a switch which you later use for other functions (like dual/triple rates or airbrakes), every time you use that other function you will also be moving the auxiliary channel.

Don't assign the function it influences each other to the same switch.

RECEIVER AND SERVO CONNECTIONS

Aircraft

CH	1AIL 1Aileron	1AIL1FLP 1Aileron 1 Flap	2AIL 2Aileron	2AIL1FLP 2Aileron 1 Flap	ELEVON
1	Aileron	Aileron	Aileron1	Aileron	Elevon1
2	Elevator	Elevator	Elevator	Elevator	Elevon2
3	Throttle	Throttle	Throttle	Throttle	Throttle
4	Rudder	Rudder	Rudder	Rudder	Rudder
5	(AUX)	Flap	(AUX)	Flap	Flap
6	(AUX)	(AUX)	Aileron6	Aileron6	(AUX)
7	(AUX)	(AUX)	(AUX)	(AUX)	(AUX)
8	(AUX)	(AUX)	(AUX)	(AUX)	(AUX)

Before use

(WING TYPE)

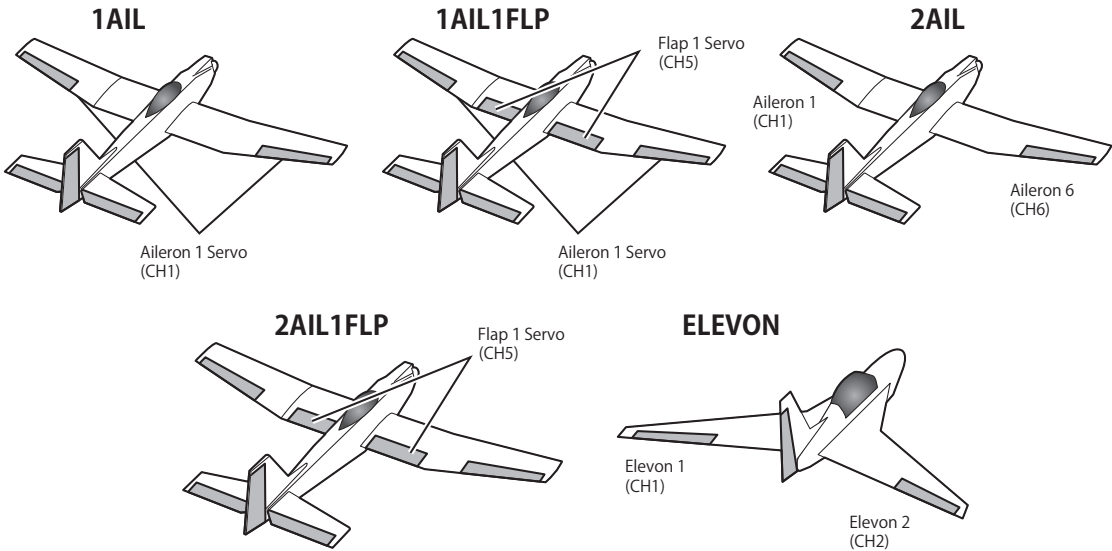

(TAIL TYPE)

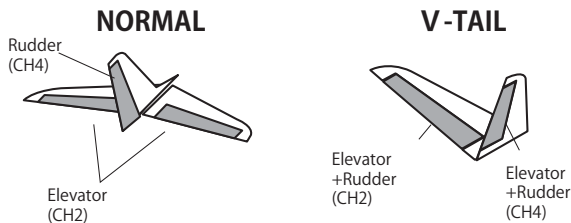

Helicopter

(Swash Type)

CH	HELICOPTER
1	Aileron (cyclic roll)
2	Elevator (cyclic pitch)
3	Throttle
4	Rudder (cyclic yaw)
5	Gyro
6	Pitch (collective pitch)
7	(AUX)
8	(AUX)

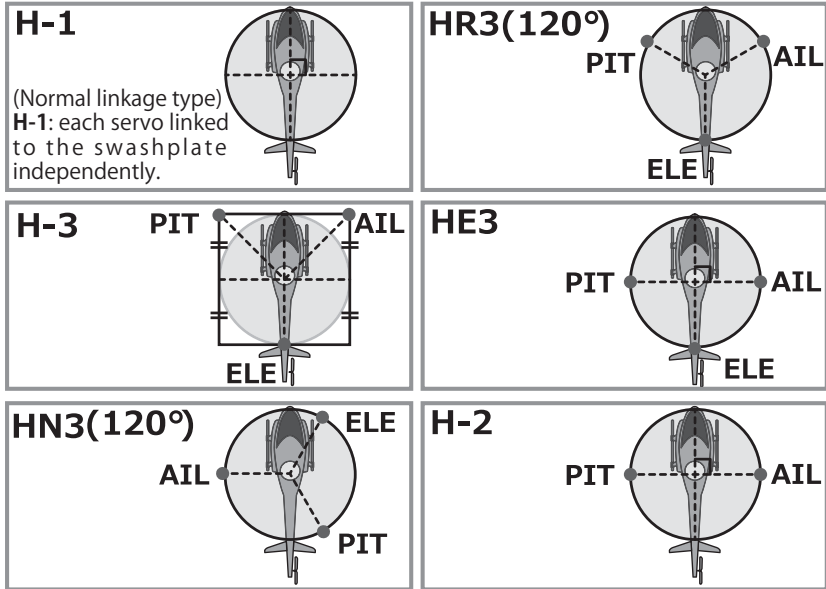

AIL : Aileron Servo
ELE : Elevator Servo
PIT : Pitch Servo

Before use

Multicopter

CH	MULTI COPTER
1	Aileron
2	Elevator
3	Throttle
4	Rudder
5	(AUX)
6	Mode for Multicopter controller
7	(AUX)
8	(AUX)

[Connection example]

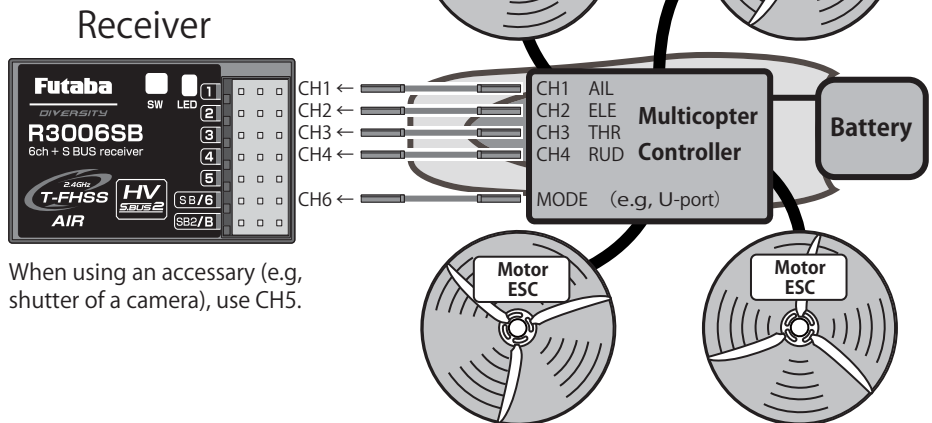

When using an accessory (e.g., shutter of a camera), use CH5.

Glider

CH	1AIL 1Aileron	1AIL1FLP 1Aileron 1 Flap	2AIL 2Aileron	2AIL1FLP 2Aileron 1 Flap	2AIL2FLP 2Aileron 2Flap
1	Aileron	Aileron	Aileron1	Aileron1	Aileron1
2	Elevator	Elevator	Elevator	Elevator	Elevator
3	Motor	Motor	Motor	Motor	Flap3
4	Rudder	Rudder	Rudder	Rudder	Rudder
5	(AUX)	Flap	(AUX)	Flap	Flap5
6	(AUX)	(AUX)	Aileron6	Aileron6	Aileron6
7	(AUX)	(AUX)	(AUX)	(AUX)	(AUX)
8	(AUX)	(AUX)	(AUX)	(AUX)	(AUX)

Before use

(WING TYPE)

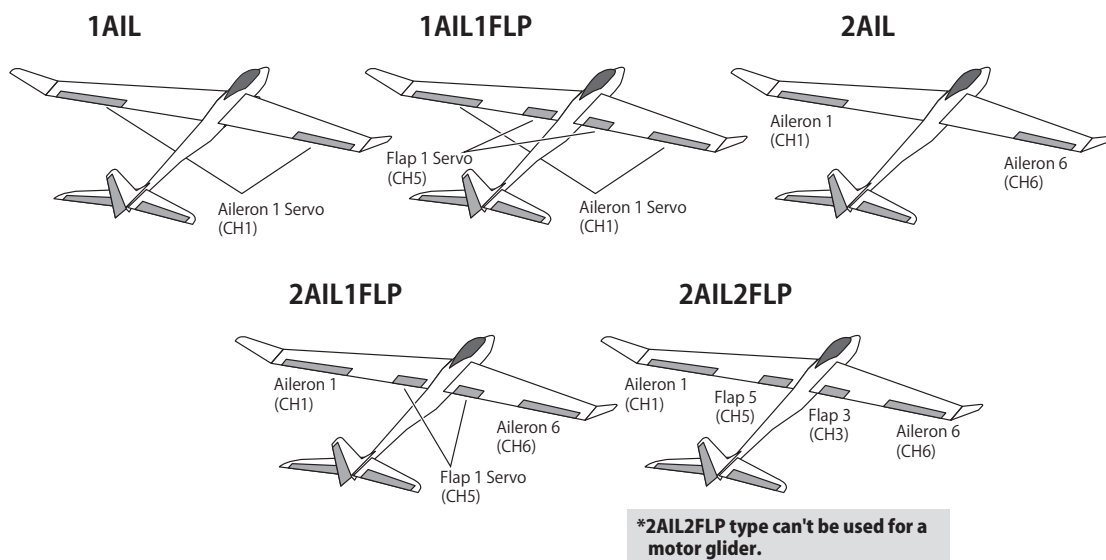

(TAIL TYPE)

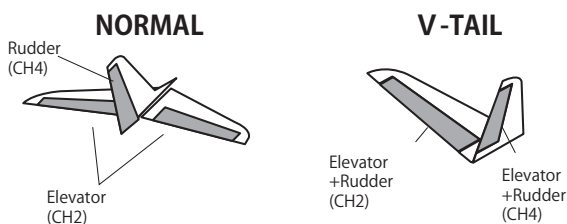

ADJUSTING THE LENGTH OF THE CONTROL STICKS

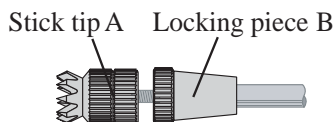

You may change the length of the control sticks to make your transmitter more comfortable to hold and operate. To lengthen or shorten your transmitter's sticks, first unlock the stick tip by holding locking piece B and turning stick tip A counterclockwise. Next, move the locking piece B up or down (to lengthen or shorten). When the length feels comfortable, lock the position by turning locking piece B counterclockwise.

STICK LEVER TENSION ADJUSTMENT

You may adjust the tension of your sticks to provide the feel that you prefer for flying. To adjust your springs, you'll have to remove the rear case of the transmitter. First, remove the battery cover on the rear of the transmitter. Next, unplug the battery wire, and remove the battery from the transmitter. Next, using a screwdriver, remove the four screws that hold the transmitter's rear cover in position, and put them in a safe place. Gently ease off the transmitter's rear cover. Now you'll see the view shown in the figure above.

Using a small Phillips screwdriver, rotate the adjusting screw for each stick for the desired spring tension. The tension increases when the adjusting screw is turned clockwise. When you are satisfied with the spring tensions, reattach the transmitter's rear cover. When the cover is properly in place, reinstall and tighten the four screws. Reinstall the battery and cover.

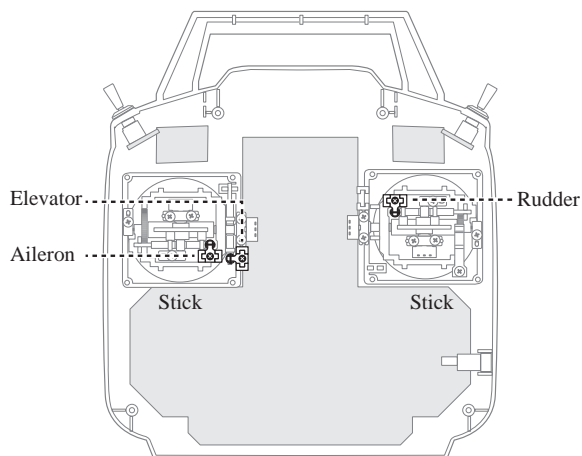
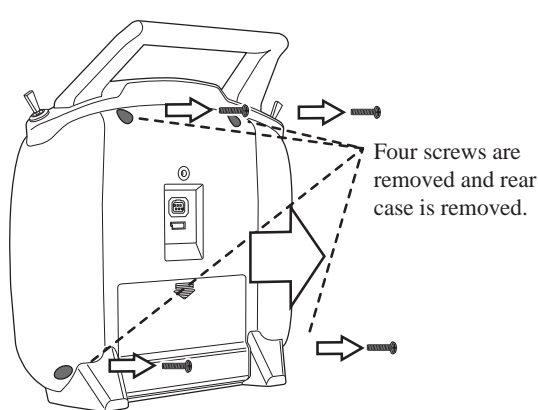

Mode 2 transmitter with rear case removed.

+ screw is clockwise.

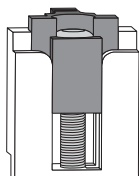

+ screw is counter-clockwise.

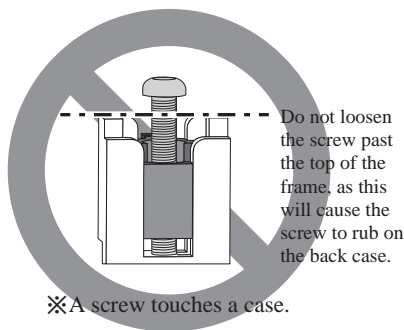
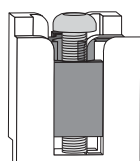

WARNING & ERROR DISPLAYS

An alarm or error indication may appear on the display of your transmitter for a number of reasons, including when the transmitter power switch is turned on, when the battery voltage is low, and several others. Each display has a unique sound associated with it, as described below.

LOW BATTERY ERROR: Warning sound: Continuous beep until transmitter is powered off.

The **LOW BATTERY** warning is displayed when the transmitter battery voltage drops below 4.1V.

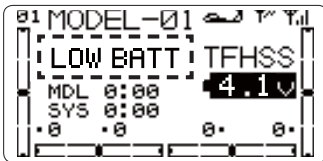

Land your model as soon as possible before loss of control due to a dead battery.

MIXING ALARM WARNING: Warning sound: Several beeps repeated until problem resolved or overridden.

**** WARNING ****

The **MIXING ALARM** warning is displayed to ALARM you whenever you turn on the transmitter with any of the mixing switches active. This warning will disappear when the offending switch or control is deactivated. Switches for which warnings will be issued at power-up are listed below. Throttle cut, idle-down, airbrake, motor SW, flight MD, throttle-stick and condition. If turning a switch OFF does not stop the mixing warning: The functions described previously probably use the same switch and the OFF direction setting is reversed. In short, one of the mixings described above is not in the OFF state. In this case, reset the warning display by pressing both **+ / - KEY** at the same time. Next, change one of the switch settings of the duplicated mixings.

*If "ESC mode" is chosen by "THR.CUT", a THR CUT will not start warning.

BACKUP ERROR: Warning sound: Several beeps (repeated continuously)

The **BACKUP ERROR** warning occurs when the transmitter memory is lost for any reason. If this occurs, all of the data will be reset when the power is turned on again.

<< BACK UP ERROR >>
MEMORY INITIALIZE
██████████ 49%

Do not fly when this message is displayed: all programming has been erased and is not available. Return your transmitter to Futaba for service.

A setup of warning of each sensor can be performed in **TELEMETRY**.

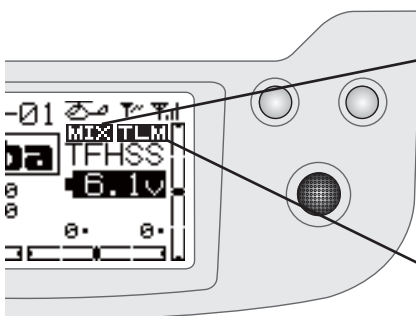

"MIX" mark is shown about warning of throttle cut, idle-down, airbrake, motor SW, flight MD, throttle-stick and condition.

"TLM" mark is shown about warning of TELEMETRY.

LINK PROCEDURE : T-FHSS (R3006SB, R3001SB etc,)

Each transmitter has an individually assigned, unique ID code. In order to start operation, the receiver must be linked with the ID code of the transmitter with which it is being paired. Once the link is made, the ID code is stored in the receiver and no further linking is necessary unless the receiver is to be used with another transmitter. When you purchase additional receivers, this procedure is necessary; otherwise the receiver will not work.

Link procedure

1. Place the transmitter and the receiver close to each other within 20 inches (half meter).



2. Turn on the transmitter.
3. Select [MDL-SEL] and access the setup screen shown below by pressing the Jog key .
4. Use the jog key to select (NO LINK) or the ID number next to LINK in the [MDL-SEL] menu.

```

MDL SEL  1 2
SELE▶ 1 MODEL-01
RX  ▶T-FHSS Air
LINK▶XXXXXXXXXX
RES ▶Execute
    
```

5. Hold down the jog key to enter the link mode.
6. A chime from the transmitter notifies the operator that the transmitter has entered the link mode.

"Beep beep beep"

(Enters the link mode for 20 seconds)

In "Link" Mode

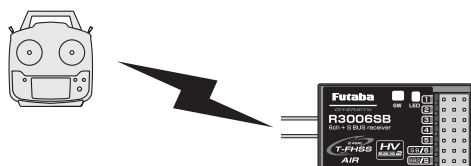

Receiver ON

7. Immediately turn on the receiver power. The receiver will enter the linking state (LED blinks red) about 3 seconds after the receiver power is turned on.

8. If the receiver ID is displayed in the transmitter and the LED changed from red blinking to a **steady green light**, linking is complete. (The receiver linking wait state ends in about 3 seconds.)
9. Check system operation. If the transmitter and receiver are not linked, try linking again.

*If there are many T-FHSS Air systems turned on in close proximity, your receiver might have difficulty establishing a link to your transmitter. This is a rare occurrence. However, should another T-FHSS Air transmitter/receiver be linking at the same time, your receiver could link to the wrong transmitter. This is very dangerous if you do not notice this situation. In order to avoid the problem, we strongly recommend you to double check whether your receiver is really under control by your transmitter.

*When the linked transmitter power is turned on, communications begins.

*When using 2 receivers, perform the linking operation the same as the 1st receiver. (However, when 2 receivers are used, the telemetry system cannot be used.)

*Link is required when a new model is made from a model selection.

⚠ WARNING

❗ After the linking is done, please cycle receiver power and check that the receiver to be linked is really under the control of the transmitter.

⊘ Don't perform the linking procedure with motor's main wire connected or with the engine operating as it may result in serious injury.

***Link is required when a new model is made from a model selection.**

***When telemetry can't be used, try a relink once again.**

LINK PROCEDURE : S-FHSS (R2001SB etc,)

Each transmitter has an individually assigned, unique ID code. In order to start operation, the receiver must be linked with the ID code of the transmitter with which it is being paired. Once the link is made, the ID code is stored in the receiver and no further linking is necessary unless the receiver is to be used with another transmitter. When you purchase additional receivers, this procedure is necessary; otherwise the receiver will not work.

Link procedure

1. Place the transmitter and the receiver close to each other within 20 inches (half meter).

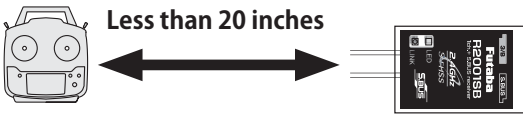

2. Turn on the transmitter.
3. Turn on the receiver.
4. **Press and hold** the **Link switch** more than two (2) seconds.

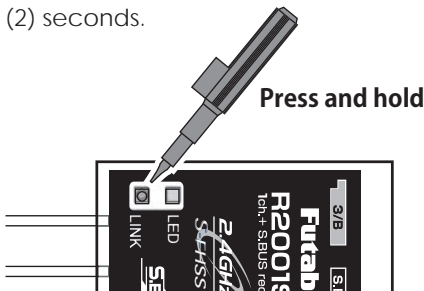

When the link is complete, the LED in the receiver changes to **solid green**. When the ID cannot be read due to the surrounding environment, try reading it with the transmitter and receiver antennas touched.

Solid green



*If there are many S-FHSS systems turned on in close proximity, your receiver might not link to your transmitter. In this case, even if the receiver's LED stays solid green, unfortunately the receiver might have established a link to one of the other transmitters. This is very dangerous if you do not notice this situation. In order to avoid the problem, we strongly recommend you to double check whether your receiver is really under control by your transmitter by giving the stick input and then checking the servo response.

Before use

R3006SB INSTALLATION

Before using the receiver, be sure to read the precautions listed in the following pages.

(Typical installation)

Mode Switch

Use the small plastic screw driver that was included with your receiver.

Switch is also used for the CH mode selection. (CH6 ↔ S.BUS)

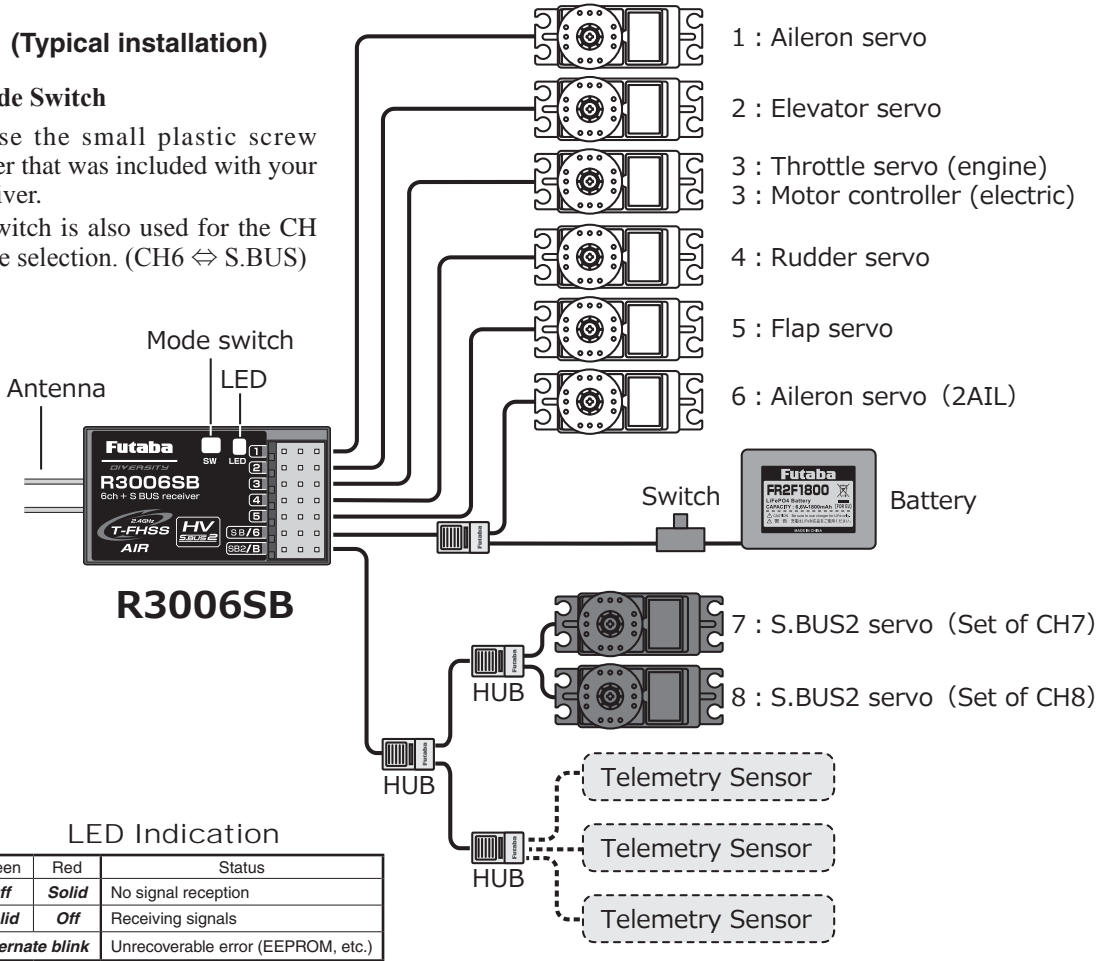

Before use

⚠ DANGER

⊘ Don't connect a connector, as shown in a before figure.

*It will short-circuit, if connected in this way. A short circuit the battery terminals may cause abnormal heating, fire and burns.

⊘ Don't connect servo for conventional system to S.BUS2 port.

*Digital servo for conventional system → It does not operate.
 *Analog servo → It may cause abnormal heat, fire and burning.

⚠ WARNING

S.BUS2 connectors

⊘ Don't connect an S.BUS servo / gyro to S.BUS2 connector.

⚠ DANGER

Receiver



⊘ Do not insert either a switch or battery in this manner.

R3006SB CH MODE

The R3006SB receiver is a very versatile unit. It has 6 PWM outputs and S.BUS2 outputs. Additionally the SB/6 outputs can be changed from channels PWM 6 channel to S.BUS.

How to change the R3006SB Channel mode (S.BUS ⇄ 6CH)

The R3006SB is capable of changing its channel allocations as described in the table below.

- 1 Turn on the receiver. (At this moment, the transmitter should be off.) Then, LED blinks RED in about 3 seconds. Next, wait until it becomes solid RED.
- 2 Press and hold the Mode switch more than 5 seconds.

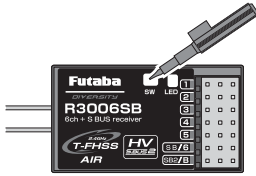

- 3 Release the button when the LED blinks RED and GREEN simultaneously.
- 4 The receiver is now in the "Operation CH Set" mode. At this moment, the LED indicates current set status through flashing a pattern that corresponds to the CH mode.

*Cannot exit this CH setting mode before the operation mode is fixed.

**See the below table that shows correspondence between "CH mode" and way of flashing LED.

***Default CH mode is "Mode A (6CH)".

- 5 By pressing the Mode switch, the operation CH is switched sequentially as " Mode A" "Mode B" "Mode A"....
- 6 The operation mode will be set by pressing the Mode switch more than 2 seconds at the desired CH mode.
- 7 Release the button when the LED blinks RED and GREEN simultaneously. Then, the operation CH is fixed.
- 8 After confirming the operation CH mode is changed, turn off and back on the receiver power.

*The "Operation CH Set" mode cannot be changed during the receiver communicates to the transmitter.

R3006SB CH Mode table

	Mode A	Mode B
6/SB	6CH	S.BUS
Red LED blink	1 time	2 time

Default CH mode

⚠ WARNING

S.BUS2 connectors

- ⊘ Don't connect servo for conventional system to S.BUS port.

*Digital servo for conventional system → It does not operate.

*Analog servo → It may cause abnormal heat, fire and burning.

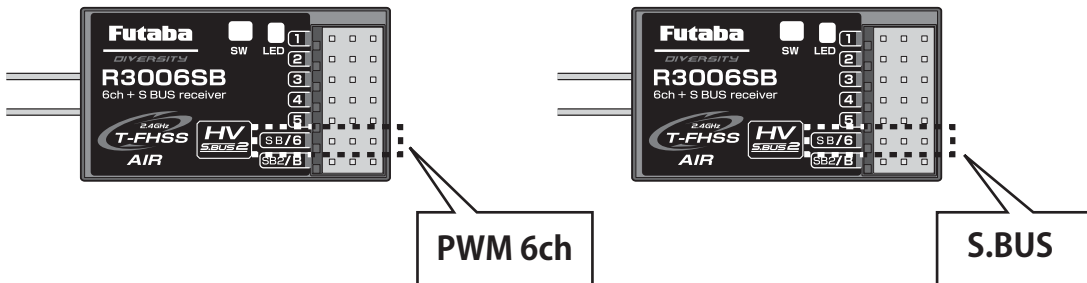

R2001SB/R3001SB INSTALLATION

Below is an example.

(Typical installation)

Before use

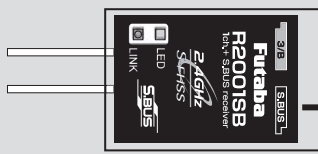

R2001SB

LED Indication

Green	Red	Status
Off	Solid	No signal reception
Solid	Off	Receiving signals
Blink	Off	Receiving signals but ID is unmatched
Alternate blink		Unrecoverable error (Memory, etc.)

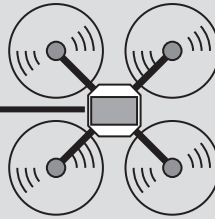

FPV

Airplane

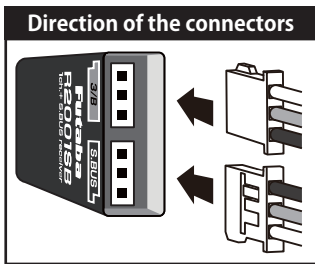

R2001SB R3001SB

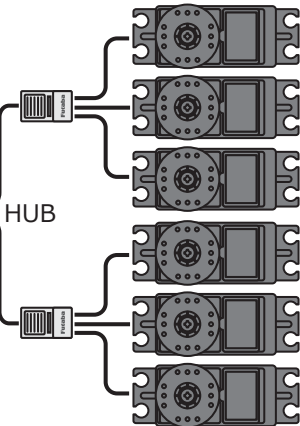
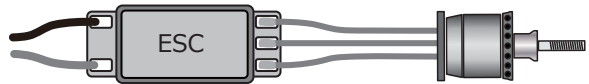

S.BUS/S.BUS2 servo
(CH # is already memorized)

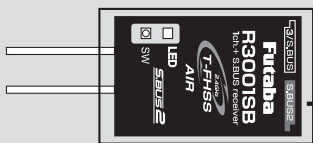

R3001SB

LED Indication

Green	Red	Status
Off	Solid	No signal reception
Solid	Off	Receiving signals
Alternate blink		Unrecoverable error (Memory, etc.)

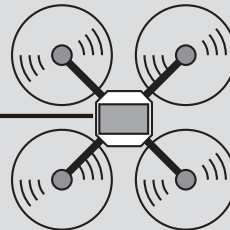

FPV

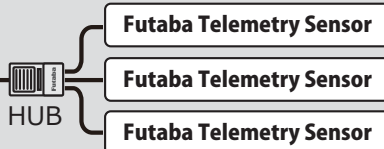

R3001SB CH MODE

The R3001SB receiver is a very compact unit. It has 3/S.BUS outputs and S.BUS2 outputs. Additionally the 3/S.BUS outputs can be changed from channels S.BUS channel to PWM 1 channel.

How to change the R3001SB Channel mode (S.BUS ⇄ 3CH)

The R3001SB is capable of changing its channel allocations as described in the table below.

- 1 Turn on the receiver. (At this moment, the transmitter should be off.) Then, LED blinks RED in about 3 seconds. Next, wait until it becomes solid RED.
- 2 Press and hold the Mode switch more than 5 seconds.

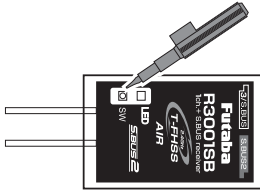

- 3 Release the button when the LED blinks RED and GREEN simultaneously.
- 4 The receiver is now in the "Operation CH Set" mode. At this moment, the LED indicates current set status through flashing a pattern that corresponds to the CH mode.

*Cannot exit this CH setting mode before the operation mode is fixed.

**See the below table that shows correspondence between "CH mode" and way of flashing LED.

***Default CH mode is "Mode B (S.BUS)".

- 5 By pressing the Mode switch, the operation CH is switched sequentially as " Mode B" "Mode A" "Mode B"....
- 6 The operation mode will be set by pressing the Mode switch more than 2 seconds at the desired CH mode.
- 7 Release the button when the LED blinks RED and GREEN simultaneously. Then, the operation CH is fixed.
- 8 After confirming the operation CH mode is changed, turn off and back on the receiver power.

*The "Operation CH Set" mode cannot be changed during the receiver communicates to the transmitter.

R3001SB CH Mode table

	Mode A	Mode B
3/S.BUS	3CH	S.BUS
Red LED blink	1 time	2 time

Default CH mode

WARNING S.BUS2 connectors

- ⊘ Don't connect servo for conventional system to S.BUS port.

*Digital servo for conventional system → It does not operate.

*Analog servo → It may cause abnormal heat, fire and burning.

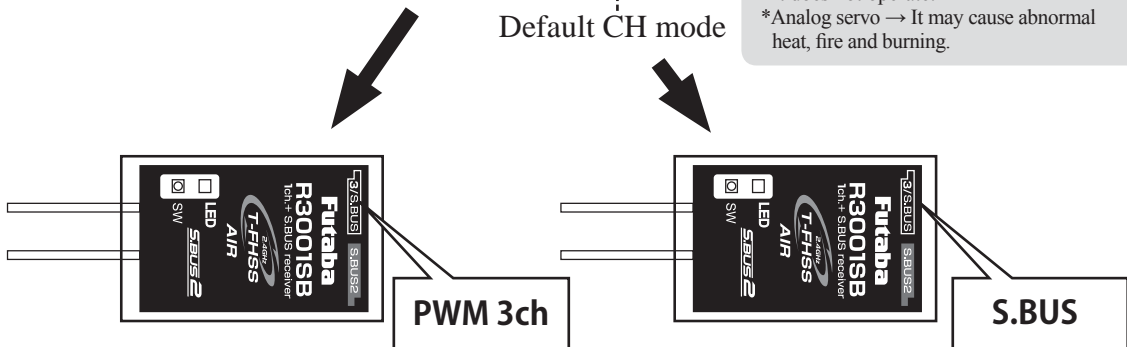

RECEIVER'S ANTENNA INSTALLATION

The R3006SB has two antennas. In order to maximize signal reception and promote safe modeling Futaba has adopted a diversity antenna system. This allows the receiver to obtain RF signals on both antennas and fly problem-free.

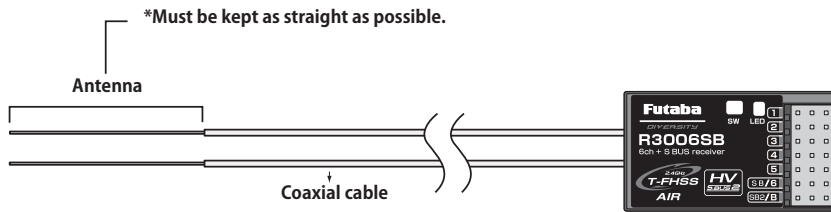

To obtain the best results of the diversity function, please refer to the following instructions:

1. The two antennas must be kept as straight as possible. Otherwise it will reduce the effective range.
2. The two antennas should be placed at 90 degrees to each other.

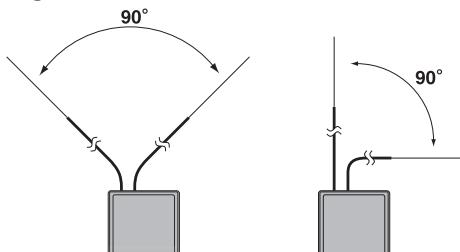

This is not a critical figure, but the most important thing is to keep the antennas away from each other as much as possible.

Larger models can have large metal objects that can attenuate the RF signal. In this case the antennas should be placed at both sides of the model. Then the best RF signal condition is obtained at any flying attitude.

3. The antennas must be kept away from conductive materials, such as metal, carbon and fuel tank by at least a half inch. The coaxial part of the antennas does not need to follow these guidelines, but do not bend it in a tight radius.
4. Keep the antennas away from the motor, ESC, and other noise sources as much as possible.

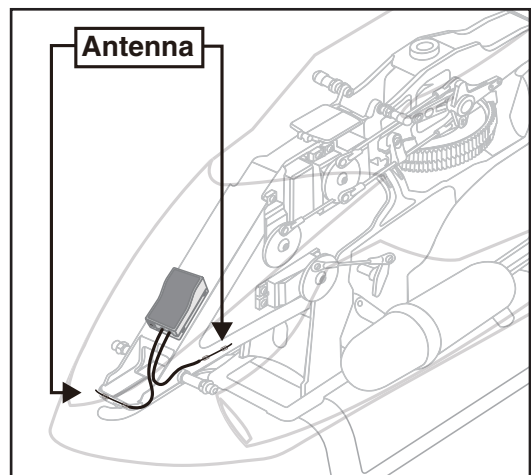
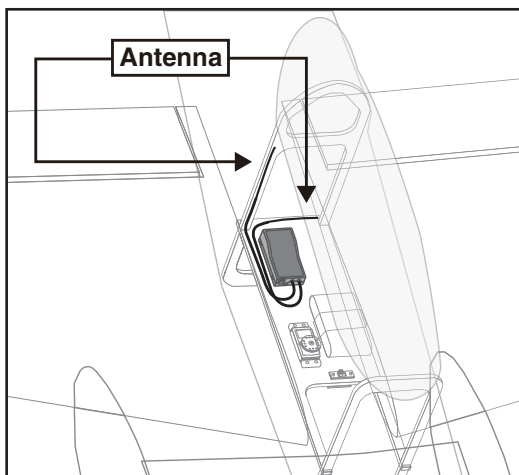

*The two antennas should be placed at 90 degrees to each other.

*The Illustration demonstrates how the antenna should be placed.

*Receiver Vibration and Waterproofing: The receiver contains precision electronic parts. Be sure to avoid vibration, shock, and temperature extremes. For protection, wrap the receiver in foam rubber or other vibration-absorbing materials. It is also a good idea to waterproof the receiver by placing it in a plastic bag and securing the open end of the bag with a rubber band before wrapping it with foam rubber. If you accidentally get moisture or fuel inside the receiver, you may experience intermittent operation or a crash. If in doubt, return the receiver to our service center for service.

MOUNTING THE SERVO

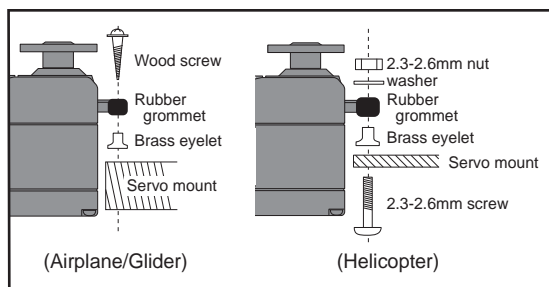

Servo lead wires

To prevent the servo lead cable from being broken by vibration during flight, provide a little slack in the cable and fasten it at suitable points. Periodically check the cable during daily maintenance.

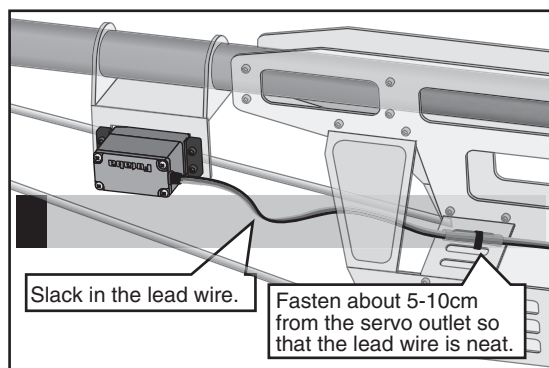

MOUNTING THE POWER SWITCH

When mounting a power switch to an airframe, make a rectangular hole that is a little larger than the total stroke of the switch so that you can turn the switch ON/OFF without binding.

Avoid mounting the switch where it can be covered by engine oil and dust. In general, it is recommended to mount the power switch on the side of the fuselage that is opposite the muffler.

SAFETY PRECAUTIONS when you install receiver and servos

⚠ WARNING

Connecting connectors

- ❗ Be sure to insert the connector until it stops at the deepest point.

How to protect the receiver from vibration and water

- ❗ Wrap the receiver with something soft such as foam rubber to avoid vibration. If there is a chance of getting wet, put the receiver in a waterproof bag or balloon to avoid water.

Receiver's antenna

- ⊘ Never cut the receiver's antenna. Do not bind the receiver's antenna with the cables for servos.

- ❗ Locate the receiver's antenna as far as possible from metals or carbon fiber components such as frames, cables, etc.

*Cutting or binding the receiver's antenna will reduce the radio reception sensitivity and range, and may cause a crash.

- ❗ Install in a way that makes sure that the 2 antennas won't touch the ground.

Servo throw

- ❗ Adjust your system so that pushrods will not bind or sag when operating the servos to the full extent.

*If excessive force is continuously applied to a servo, the servo could be damaged due to force on the gear train and/or power consumption causing rapid battery drain.

Mounting servos

- ❗ Use a vibration-proof rubber (such as rubber grommet) under a servo when mounting the servo on a servo mount. And be sure that the servo cases do not touch directly to the metal parts such as servo mount.

*If the servo case contacts the airframe directly, vibration will travel to and possibly damage the servo.

RANGE CHECK THE RADIO

A range check must be performed before the first flight of a new model. It is not necessary to do a range check before every flight (but is not a bad idea to perform a range check before the first flight of each day). A range check is the final opportunity to reveal any radio malfunctions, and to be certain the system has adequate operational range.

We have installed a special "Power Down Mode" in the T6K in order to perform an operational ground range check. During this mode, the RF power is reduced in order to test the operational range of the T6K.

To activate the power down mode and perform a range check:

1) To activate the "Power Down Mode" please hold down the **JOG KEY** and then turn the transmitter switch on. A power mode screen is displayed. Press the **JOG KEY** to select the Power Down function. When this mode is active the blink on the LED lighting from of the transmitter will provide users with an audible and visual indication that the transmitter is in the "Power Down Mode". Audibly, the transmitter will beep one time every three seconds. Visually, the LCD screen will display "POWER DOWN MODE". The words "POWER DOWN MODE" will blink as an additional reminder that the transmitter is in the "Power Down Mode".

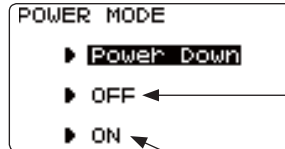

Select the "**OFF**" and press the **Jog key**. A screen opens without outputting power. The receiver does not operate.

Select the "**ON**" and press the **Jog key**. Power is usually outputted from power mode.

2) With the "Power Down Mode" activated, walk away from the model while simultaneously operating the controls. Have an assistant stand by the model and signal what the controls are doing to confirm that they operate correctly. You should be able to walk approximately 30-50 paces from the model without losing control.

3) If everything operates correctly, return to the model. Push **END KEY** and complete power down mode. Set the transmitter in a safe yet accessible location so it will be within reach after starting the engine. Be certain the throttle stick is all the way down, and then start the engine. Perform another range check with your assistant holding the model and the engine running at various speeds.

If the servos jitter or move inadvertently, there may be a problem. Do NOT fly the aircraft! Look for loose servo connections or binding pushrods. Also be certain that the battery has been fully charged.

4) NEVER start flying when the "Power Down Mode" is active.

Servo test operation at the time of power down mode:

During Power Down mode, you can use automatic servo testing to check the range of a specified servo (it moves to right and left slowly).

1) A "SERVO" is chosen from a menu.

2) **JOG KEY** is moved to a side and 2 pages is called. Next, **JOG KEY** is moved down and CH is displayed.

3) CH of the servo which wants to operate is chosen. Then, the + **KEY** is pressed and it is made ACT.

The servo selected during Power Down Mode operates alone, allowing you to check its operation.

It is during Power Down Mode starting, and if "SERVO TEST" is turned ON, it will move.

*In the Power Down Mode, the throttle servo does not operate.

*Helicopter mode, condition is fixed to NOR.

DANGER

 NEVER start flying when the "Power Down Mode" is active.

*Control is impossible and your model crashes.

S.BUS/S.BUS2 INSTALLATION

This set uses the S.BUS/S.BUS2 system. The wiring is as simplified and clean mounting as possible, even with models that use a large number of servos. In addition, the wings can be quickly installed to the fuselage without any extraneous wiring by the use of only one simple wire, even when there are a large number of servos used.

- When using S.BUS/S.BUS2, special settings and mixes in your transmitter may be unnecessary.
- The S.BUS/S.BUS2 servos memorize the number of channels themselves. (Settable with the T6K)
- The S.BUS/S.BUS2 system and conventional system (receiver conventional CH used) can be mixed.

S.BUS Glider usage example

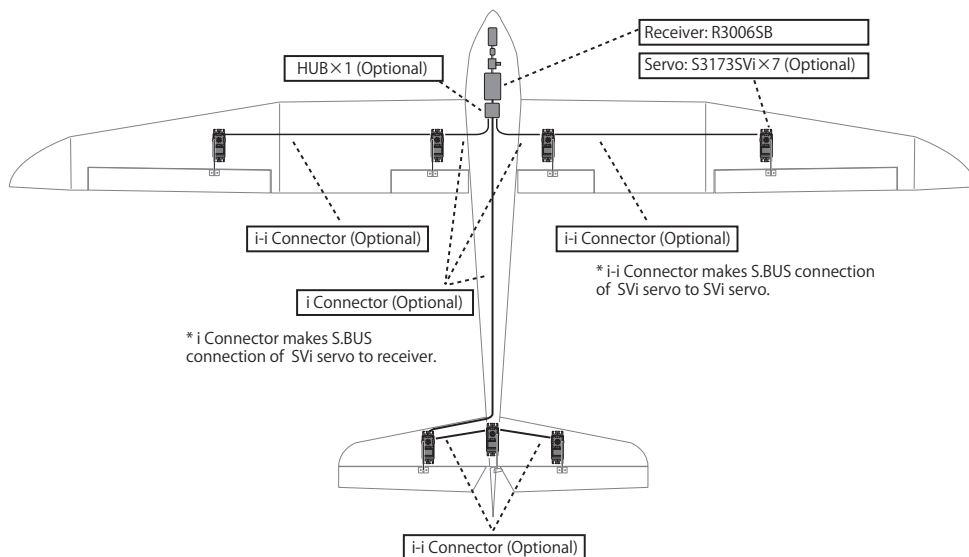

S.BUS Aerobatic plane usage example

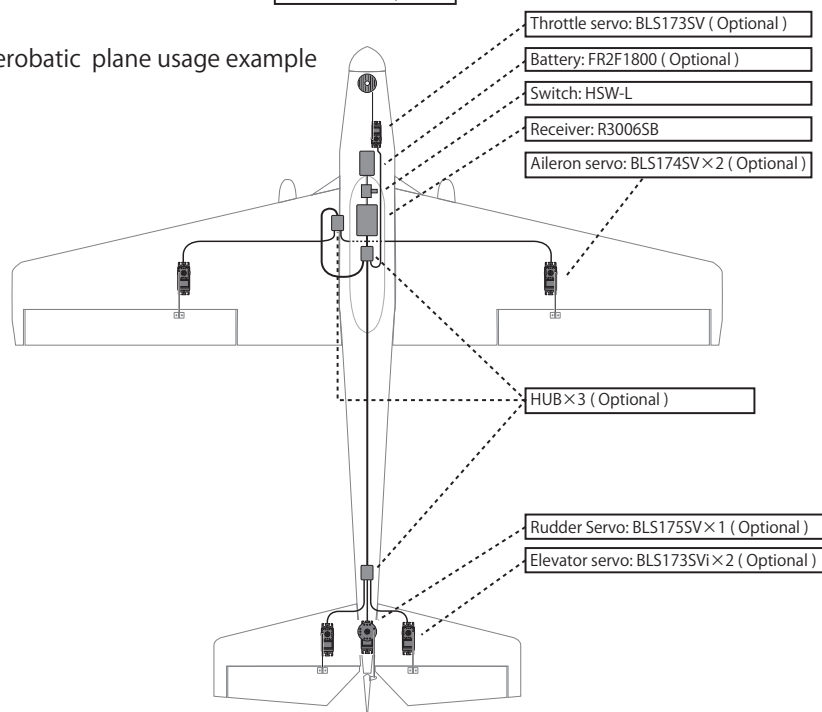

S.BUS WIRING EXAMPLE

Before use

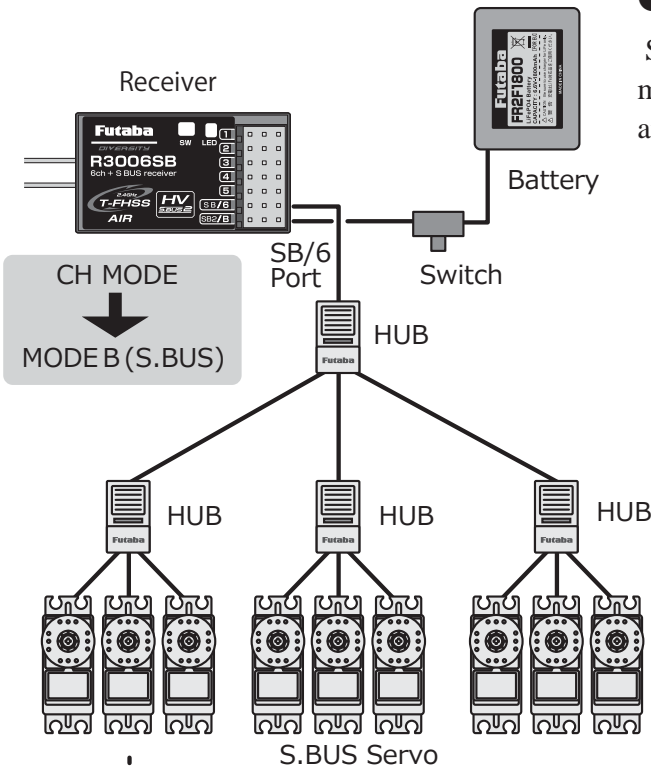

● S.BUS Servo

Since the channel number is memorized by the S.BUS itself, any connector can be used.

Optional Parts

● 4-Terminal box

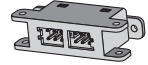

Four connectors can be inserted

Optional Parts

● 6-Terminal box (TB16PP)

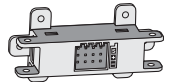

Six connectors can be inserted

⚠ WARNING

Power supply

❗ Please make sure that you use a battery that can deliver enough capacity for the number and kind of servos used. Alkaline batteries cannot be used.

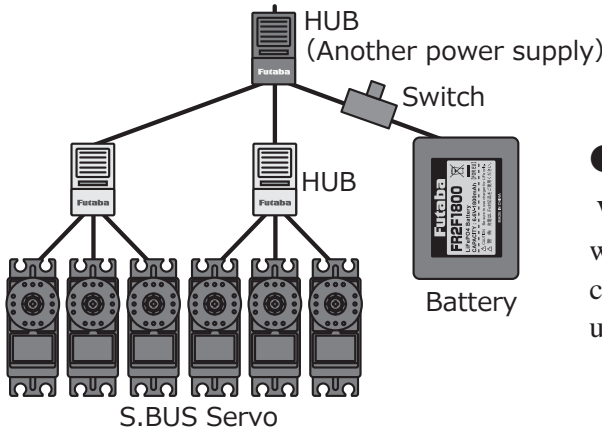

● When separate power supply used

When a large number of servos are used or when high current servos are used, the servo can be driven by a separate power supply by using a separate Power Supply 3-way Hub.

Optional Parts

HUB

Orange

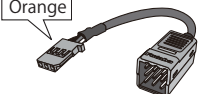

Three connectors can be inserted.

Optional Parts

HUB

Green

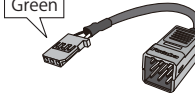

Used when using a separate power supply battery.

S.BUS2 SYSTEM

When using the S.BUS2 port, an impressive array of telemetry sensors may be utilized.

S.BUS2 TABLE

Receiver port	S.BUS Servo S.BUS Gyro	S.BUS2 Servo S.BUS2 Gyro	Telemetry sensor
S.BUS	○	○	×
S.BUS2	×	○	○

(※) Don't connect S.BUS Servo,
S.BUS Gyro to S.BUS2 connector.

S.BUS servos and gyros and S.BUS2 servos and gyros must be used in the correct receiver ports. Please refer to the instruction manual to make sure you connect to the correct one.

Before use

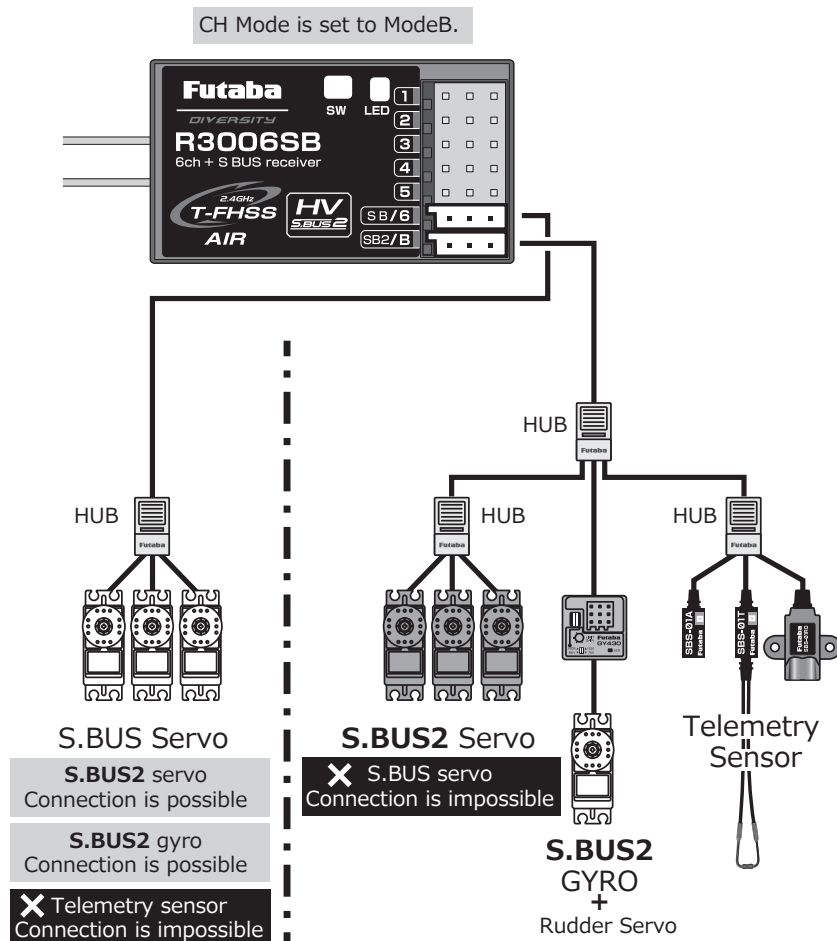

S.BUS/S.BUS2 DEVICE SETTING

S.BUS/S.BUS2 servos or a telemetry sensor can be connected directly to the T6K. Channel setting and other data can be entered for the S.BUS/S.BUS2 servos or sensors.

Back of T6K

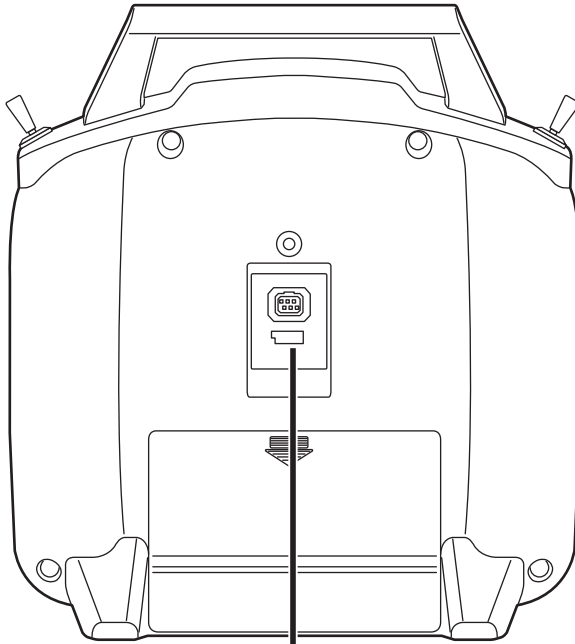

3-way hub
or Y-harnesses



S.BUS/S.BUS2
device
(S.BUS/S.BUS2
Servo)
(Telemetry sensor)



Receivers
Battery

1. Turn on the transmitter power.
2. Call the setup screen.
MENU → S.BUS
3. Connect the S.BUS device and battery you want to set with a 3-way hub or Y-harnesses as shown in the figure.
4. Perform setting in accordance with each screen.
5. This sets the channel and other data for each S.BUS servo, or telemetry device to be used with the S.BUS device or receiver.

TELEMETRY SYSTEM

The R3006SB receiver features bi-directional communication with a T-FHSS Air Futaba transmitter using the S.BUS2 port. Using the S.BUS2 port an impressive array of telemetry sensors may be utilized. It also includes both standard PWM output ports and S.BUS output ports.

- *Telemetry is available only in the T-FHSS Air mode.
- *The telemetry function requires the corresponding receiver (R3006SB).
- *The T6K will enter and keep the ID number of the R3006SB that it is linked to.
- *When you use two or more R3006SB, set telemetry mode to INH.

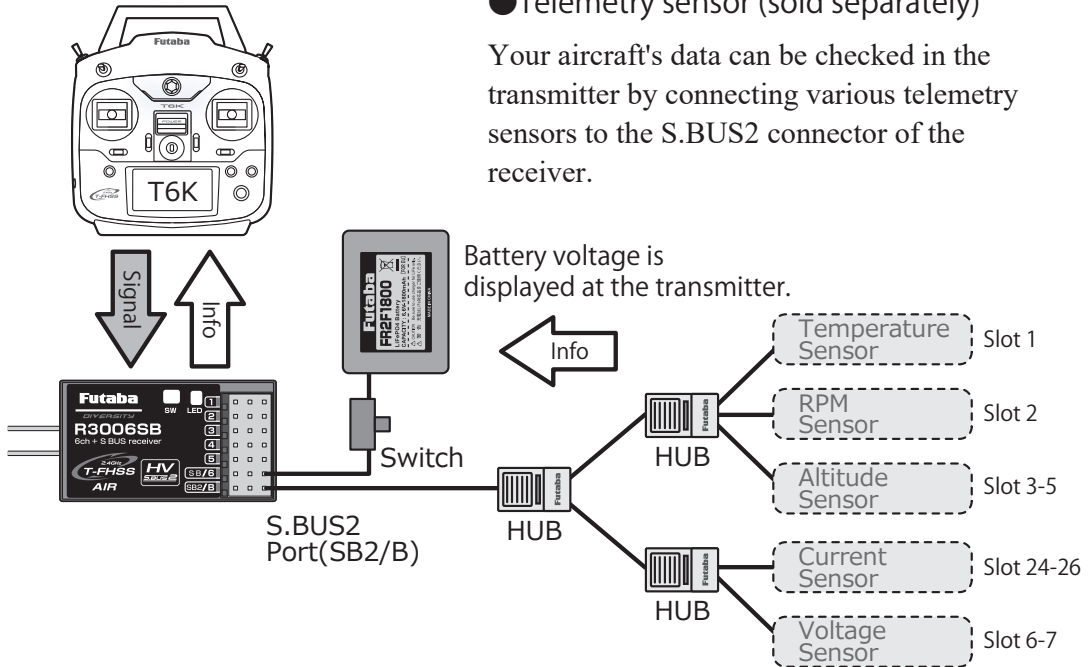

Before use

● Slot Number

Servos are classified by channel, but sensors are classified by “slot”. Since the initial slot number of the T6K is preset at each sensor, the sensors can be used as is by connecting them. There are 1-31 slots.

Airplane in the sky

- Receiver Voltage
- Altitude
- Engine Temperature
- Propeller R.R.M
- Battery Current
- Battery Voltage

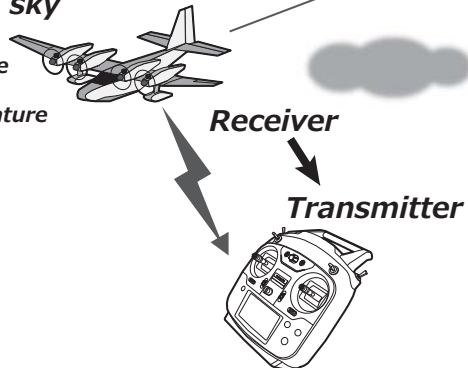

Displayed at the transmitter

Common function



The setting screens are called from the following menu. All the functions common to airplane, helicopter, glider, and multicopter model types are shown here.



- First set the throttle to low.

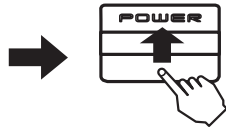

- Then turn on the power.

(Home screen)

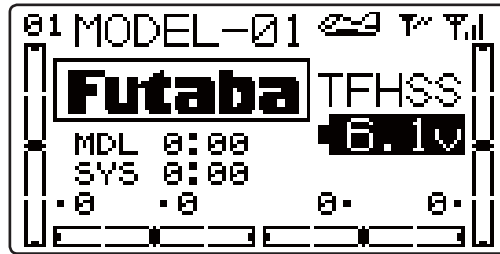

- When the **END** key is pressed, the display returns to the home screen.

END

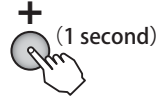

(1 second)

- When the **+** key is pressed for 1 second, the menu screen is displayed.

To menu screen by holding down the + key

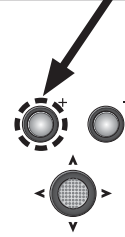

Common function

MENU

MENU 1/4

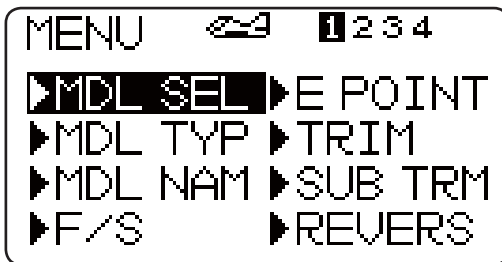

MENU 2/4

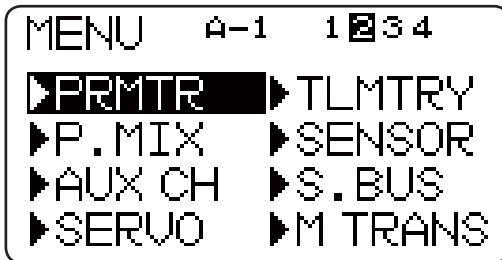

MENU 3/4

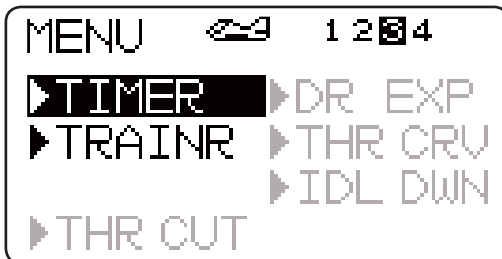

(Selection)

- Move the cursor (highlighted) up and down and to the left and right with the **Jog** key and select the function. The cursor can be moved over several pages.

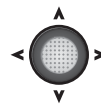

(Calling the setting screen)



- Press the **Jog** key to open the setting screen.

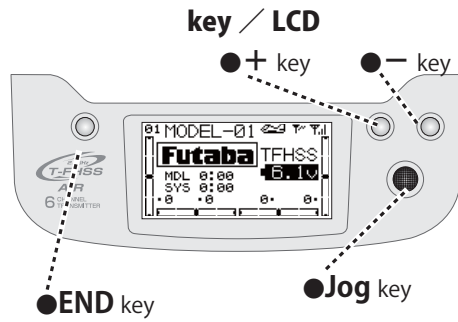

Function

◆ MENU 1/3

MDL SEL	P.52
MDL TYP	P.55
MDL NAM	P.57
F/S	P.59
E POINT	P.61
TRIM	P.62
SUB TRM	P.63
REVERS	P.64

◆ MENU 2/3

PRMTR	P.65
P.MIX	P.70
AUX CH	P.73
SERVO	P.74
TLMTRY	P.75
SENSOR	P.91
S.BUS	P.93
M TRANS	P.96

◆ MENU 3/3

TIMER	P.97
TRAINR	P.100

Common function



MDL SEL Model select (Select / RX type / Link / Reset / Copy) (Common)

Function

This function is used when calling and copying model data stored in the transmitter. The selected model data can also be reset. System changes (T-FHSS Air, S-FHSS) matched to the receiver type and linking with the receiver are also done here.

Model select (SELE)

The model data of up to 30 models can be stored in the transmitter. This function is used when calling saved model data.

Receiver selection (RX)

The R3006SB supplied with the transmitter, employs the T-FHSS Air system. When you want to use an S-FHSS receiver, switch to S-FHSS here. However, the telemetry function cannot be used with the S-FHSS system.

Link (LINK)

When linking with the receiver, the transmitter is set to the link mode here. The ID number of the currently linked receiver is displayed.

Data reset (RES)

The model data currently in use can be reset to its initial value. However, it does not Reset other than the following of a **parameter**.

[The function reset in a parameter : **TELEMETRY mode, STK POSI ALRM**]

Model copy (COPY)

This is the model data copy function. It is convenient when you want to store model data as backup or build a number of models with the same data settings.

- The data of the model memory currently in use can be copied to another model memory.

Common function

Method

Calling the setting screen

① Call the menu screen from the home screen by pressing the **+** key for 1 second.



② Select **"MDL SEL"** from the menu with the **Jog** key.

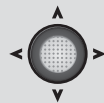

③ Open the setting screen by pressing the **Jog** key.



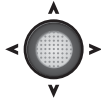

- Select the setting item with the **Jog** key.

```

MDL SEL 02 012
SELE ▶ 1 MODEL-01
RX ▶ T-FHSS Air
LINK ▶ 131300099
RES ▶ Execute
          
```

(Model number : 1-30)

- Original data : Model type
Model name
- System (T-FHSS Air or S-FHSS)
- Link receiver ID
If telemetry is used, the receiver ID is needed.



Model select

- ① Select the **SELE** item and then select the model number by pressing the **+ key** or **- key**.



Selection range : 1-30

- ② Press the **Jog key** for 1 second.



- Confirmation message "sure?" blinks.

- ③ Select the model by pressing the **Jog key**.



- A confirmation "beep" sounds to show that selection is complete.

For safety, a double setting system is used. When a change is cancelled after the confirmation message is displayed, the change is not made when moved to another setting item by Jog key.

RX type

- ① Select the **RX** item and then select **T-FHSS Air** or **S-FHSS** by pressing the **+ key** or **- key**.

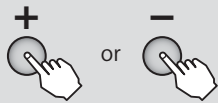

Selection range :
T-FHSS Air, S-FHSS

- Confirmation message "sure?" blinks.

- ② RX type change by pressing the **Jog key**.



- A confirmation "beep" sounds is complete.

For safety, a double setting system is used. When a change is cancelled after the confirmation message is displayed, the change is not made when moved to another setting item by Jog key.

Common function

Link

- ① Select the **LINK** item and then press the **Jog key** for 1 second.



- **T-FHSS Air** only. **S-FHSS** does not enter the link mode. Use the receiver link button to link the receiver.

- ② Enters the link mode for about 20 seconds. During this time, bring the receiver near the transmitter and turn on the receiver power. When linking, the receiver ID is displayed.

- In the link mode, a confirmation "beep" sounds and the time remaining is displayed on the screen. When 20 seconds have elapsed, a continuous beep sounds and the link mode is exited.

For safety, linking must not be performed while the drive motor or engine is running. When linking is complete, turn the power off and on and check operation.

***Link is required when a new model is made from a model selection.**



Date reset

- ① Select the **RES** item and then press the **Jog key** for 1 second.



- Confirmation message "**sure?**" blinks.

- ② Date reset by pressing the **Jog key**.



- A confirmation "beep" sounds and "**Complete**" is displayed on the screen is complete.

For safety, a double setting system is used. When a change is cancelled after the confirmation message is displayed, the change is not made when moved to another setting item by Jog key.

⚠ CAUTION Throttle Reverse

- ❗ Only the throttle channel (CH3) initial setting is REV (reverse). Thoroughly check the Hi and Low directions of the engine or motor used and be careful that they do not suddenly run at full speed. Even after data reset, CH3 is reversed.

Model copy

- ① Select the **COPY** item and the select the model number of the copy destination by pressing the **+ key** or **- key**.



Selection range : 1-30

- ② Press the **Jog key** for 1 second.



- Confirmation message "**sure?**" blinks.

- ③ Copy the model by pressing the **Jog key**.



- A confirmation "beep" sounds and "**Complete**" is displayed on the screen to show that copying is complete.

For safety, a double setting system is used. When a change is cancelled after the confirmation message is displayed, the change is not made when moved to another setting item by Jog key.

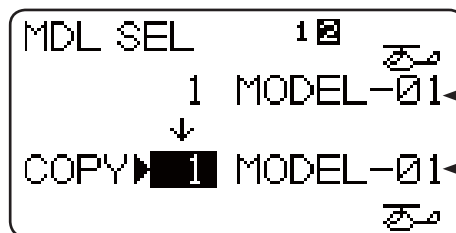

- Original data : Model type Model name

- Copy place : Model type Model name



MDL TYP Model type (Common)

Function

Six swash types are available for helicopters. Five types of main wings and two types of tail wings are available for airplanes and gliders. Functions and mixing functions necessary for each model type are set in advance at the factory.

Note: The Model Type function automatically selects the appropriate output channels, control functions, and mixing functions for the chosen model type.

When the Model Type selection command is accessed, all of the data in the active memory is cleared (except the following swash type.) Be sure that you don't mind losing this data, or back it up to another memory using the copying functions.

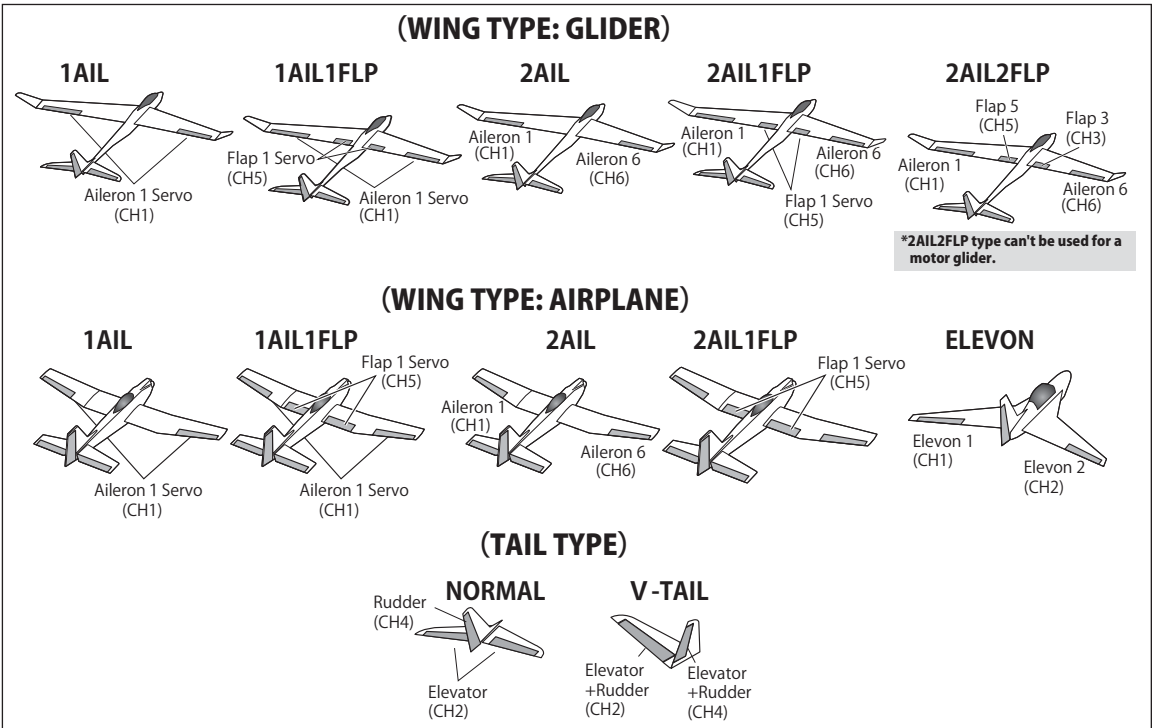

Common function

(SWSH TYPE: HELICOPTER)

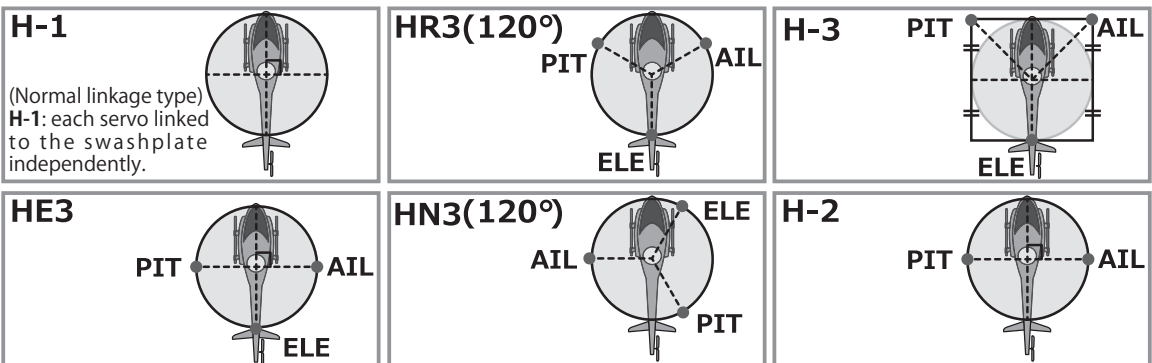

AIL : Aileron Servo
ELE : Elevator Servo
PIT : Pitch Servo



Model type

① Select the **"TYPE"** item and then select the model type by pressing the **+ key** or **- key**.



● The new model type is displayed on the screen.

② Press the **Jog key** for 1 second.

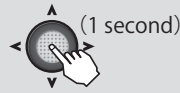

● Confirmation message **"sure?"** blinks.

③ Model type change by pressing the **Jog key**.

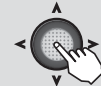

● A confirmation "beep" sounds is complete.

For safety, a double setting system is used. You need to confirm your setting changes by pressing the jog key. If you fail to press the jog key and see new model type on your screen, your changed are not saved.

Selection range :
AIRPLANE, HELICOPTER, GLIDER,
MULTI COPT

Wing type (for Airplane /Glider)

① Select the **"WING"** item and then select the swash type by pressing the **+ key** or **- key**.

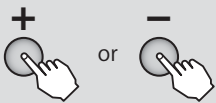

For safety, a double setting system is used. When a change is cancelled after the confirmation message is displayed, the change is not made when moved to another setting item by Jog key.

② Press the **Jog key** for 1 second.

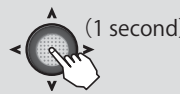

● Confirmation message **"sure?"** blinks.

③ Swash type change by pressing the **Jog key**.



● A confirmation "beep" sounds is complete.

Selection range : 1AIL, 1AIL1FLP,
2AIL, 2AIL1FLP, ELEVON(Airplane),
2AIL2FLP(Glider)

Tail type (for Airplane /Glider)

① Select the **"TAIL"** item and then select the swash type by pressing the **+ key** or **- key**.

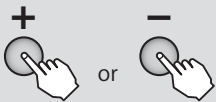

For safety, a double setting system is used. When a change is cancelled after the confirmation message is displayed, the change is not made when moved to another setting item by Jog key.

② Press the **Jog key** for 1 second.



● Confirmation message **"sure?"** blinks.

③ Swash type change by pressing the **Jog key**.



● A confirmation "beep" sounds is complete.

Selection range : NORMAL,
V-TAIL

Swash type (for Heli)

① Select the **"SWSH"** item and then select the swash type by pressing the **+ key** or **- key**.



For safety, a double setting system is used. You need to confirm your setting changes by pressing the jog key. If you fail to press the jog key and see new swash type on your screen, your changed are not saved.

② Press the **Jog key** for 1 second.

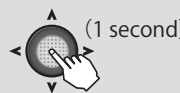

● Confirmation message **"sure?"** blinks.

③ Swash type change by pressing the **Jog key**.



● A confirmation "beep" sounds is complete.

Selection range : H-1, HR3,
H-3, HE3, HN3, H-2



MDL NAM Model name / User name (Common)

Function

A model name is inputted into each model in T6K.

User name is inputted into T6K.

Model name setting (MDL NAME)

This function assigns a name to the model data. The model name is displayed on the top row of the home screen. This serves to prevent model memory mistakes if the current aircraft name or other name is entered.

- Up to 8 characters can be set.

User name setting (USR NAME)

The user name displayed on the home screen can be set. (When a user name is not set, the Futaba logo is displayed) When the home screen display is changed to USR-NAME by PARAMETER, the set user name is displayed on the home screen.

- Up to 8 characters can be set.

Method

Calling the setting screen

- ① Call the menu screen from the home screen by pressing the **+ key** for 1 second.



- ② Select **"MDL NAM"** from the menu with the **Jog key**.

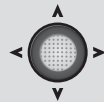

- ③ Open the setting screen by pressing the **Jog key**.

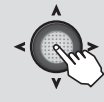

Model name

User name

(Reset)

(Candidate characters)

● Characters that can be entered ;
Numeric/upper case alphabet/
lower case alphabet

Model name

- ① Move the cursor to the model name digit you want to change by pressing the **+ key** or **- key**.



- ② Move the cursor to the candidate character you want to change with the **Jog key**.

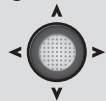

- ③ Change the character by pressing the **Jog key**.



Set the model name by repeating steps ① to ③ above.

Reset method : When the cursor is moved to any digit of the model name by + key or - key and the Jog key is pressed in the state in which the cursor was moved to RESET by Jog key, the model name returns to its initial setting.



User name

① Move the cursor to the user name digit you want to change by pressing the **+ key** or **- key**.

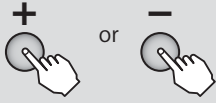

② Move the cursor to the candidate character you want to change with the **Jog key**.

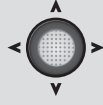

③ Change the character by pressing the **Jog key**.

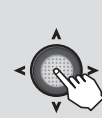

Set the user name by repeating steps ① to ③ above.

Reset method: When the cursor is moved to any digit of the user name by + key or - key and the Jog key is pressed in the state in which the cursor was moved to RESET by Jog key, the user name returns to its initial setting.

Displaying the user name on the home screen

The set user name can be displayed on the home screen. (When a user name is not set, the Futaba logo is displayed.) When the home screen display is changed to USR-NAME by PARAMETER, the set user name is displayed.

Common function

Calling the setting screen

① Call the menu screen from the home screen by pressing the **+ key** for 1 second.



② Select **"PRMTR"** from the menu with the **Jog key**.

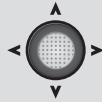

③ Open the setting screen by pressing the **Jog key**.



Parameter

① Select **"HOME-DSP"** from the parameter 2 page with the **Jog key**.

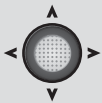

② Select **"U-NAME"** by pressing the **+ key** or **- key**.



③ **End** setting by pressing the **END key**.





F/S

Fail safe

(Common)

Function

When normal radiowaves cannot be received due to noise and interference, the NOR mode, which holds the servo of each channel in its position immediately before reception was lost, or F/S (Fail Safe) mode, which moves the servo of each channel to a preset position, can be selected. When T-FHSS Air is selected, the battery fail safe voltage can be set.

- When the throttle channel was reversed by servo reverse function, the F/S data is also reversed.
- If the receiver battery voltage drops below the set value when the fail safe mode was selected, the battery fail safe function moves the servo to a preset position.
- The S-FHSS fail safe voltage is 3.8V.

- When this function was performed reset the battery fail safe function by the following method and immediately land.

Reset method : The battery fail safe function can be temporarily disabled by moving the throttle stick to the slowest side. However, after 30 seconds the battery fail safe function will return to the battery fail safe state.

⚠ WARNING

For safety, always set the fail safe functions.

- Remember to set the throttle channel fail safe function so that the servo moves to the maximum slow side for airplanes and to the slow side from the hovering position for helicopters. Crashing of the model at full high when normal radio waves cannot be received due to interference, etc., is very dangerous.
- If the battery fail safe is reset by the throttle stick, it may be mistaken for an engine malfunction and will be reset at throttle slow and the model will continue to fly. If you have any doubts, immediately land.

Method

Calling the setting screen

- 1 Call the menu screen from the home screen by pressing the **+ key** for 1 second.



- 2 Select **"F/S"** from the menu with the **Jog key**.

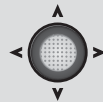

- 3 Open the setting screen by pressing the **Jog key**.

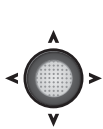

F/S Position
Mode select

FAIL SAFE	1	2	3
TFHSS			
MODE. POSI	B-F/S		
5: AUS	NOR	---	---
6: MOD	NOR	---	---
7: AU7	NOR	---	---
8: AUS	NOR	---	---

Battery-F/S : ON/OFF

- Select the setting item with the **Jog key**.

Fail safe

Mode selection

- 1 Select the mode by pressing the **+ key** or **- key** at the MODE item of each channel.

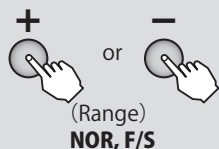

(When F/S mode was selected)

F/S position

- 2 In the mode selected state, set the F/S position by holding the stick of that channel in the position you want to set and press the **Jog key** for 1 second.
- A confirmation beeping sounds to show that the servo position was set.

When using the B-F/S mode

- 1 Select ACT by pressing the **+ key** or **- key** at the B-F/S item.

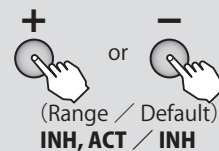

Common function



Battery fail safe voltage setting

- ① Select **BATTERY F/S VOLTAGE** on page 3 of the fail safe screen with the **Jog key**.



- ② Set the voltage by pressing the + key or – key.



(Set up range)

3.8V 4.0V 4.2V 4.4V 4.6V 4.8V
5.0V 5.3V 5.6V 5.9V 6.2V 6.5V
6.8V 7.1V 7.4V

- ③ End setting by pressing the **END key**.





E POINT End point

(Common)

Function

The End Point function adjusts the left and right servo throws, generates differential throws, and will correct improper linkage settings.

- The servo travel can be adjusted individually at the left and right sides.

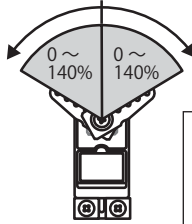

Servo throw

At 100% setting the servo throw of each channel is about 40° for channels 1 to 4 and about 55° for channels 5-8. However, the maximum servo travel for channels 5-8 is about 110%.
*When channels 5 to 6 were mixed by 2 AIL etc, the throw becomes the same (about 40°) as channels 1 to 4.

Method

Calling the setting screen

- ① Call the menu screen from the home screen by pressing the **+** key for 1 second.



- ② Select **"E POINT"** from the menu with the **Jog** key.

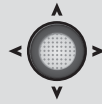

- ③ Open the setting screen by pressing the **Jog** key.



- Select the channel with the **Jog** key.

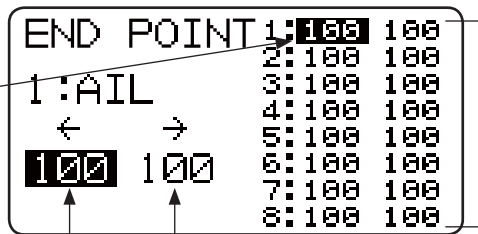

- The setting rate of each channel

(Left / Down) rate display (Right / Up) rate display

Select the Left/Right (Down/Up) with the **stick (SW,VR)**.

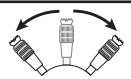

< ChannelDisplay >

AIRPLANE (2AIL1FLP)	HELICOPTER	GLIDER (2AIL2FLP)	MULTICOPTER
1: AIL (Aileron1)	1: AIL (Aileron)	1: AIL (Aileron1)	1: AIL (Aileron)
2: ELE (Elevator)	2: ELE (Elevator)	2: ELE (Elevator)	2: ELE (Elevator)
3: THR (Throttle)	3: THR (Throttle)	3: FL3 (Flap3)	3: THR (Throttle)
4: RUD (Rudder)	4: RUD (Rudder)	4: RUD (Rudder)	4: RUD (Rudder)
5: FLP (Flap)	5: GYRO (GYRO)	5: FL5 (Flap5)	5: AUX
6: AIL6 (Aileron6)	6: PIT (Pitch)	6: AIL6 (Aileron6)	6: MOD (Mode)
7: AUX	7: AUX	7: AUX	7: AUX
8: AUX	8: AUX	8: AUX	8: AUX

End point

- ① A channel is chosen by **Jog** key.



Selection range : CH1-8

- ② Operate the stick or VR of the selected channel fully to the left (down) or right (up) and adjust the rate by pressing the **+** key or **-** key.



Range : 0-140%
Default : 100%

- When you want to return the set value to the initial value, press the **+** key and **-** key simultaneously.

Adjust the rate of each direction of the stick and VR by repeating step ①.

Common function



TRIM

Trim reset / Trim step

(Common)

Function

Trim Step

The amount of trim change per step can be changed between 1 and 40 according to the aircraft capacity and trim application.

Set it to match the application. With ordinary

aircraft, a setting of about 2 to 10 should be fine. (Initial value: 4)

Trim Type

The amount of trim change trim type can be changed between NOR (normal), ATL and CNT (center) according to the trim application.

Method

Calling the setting screen

① Call the menu screen from the home screen by pressing the **+ key** for 1 second.



② Select **"TRIM"** from the menu with the **Jog key**.

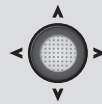

③ Open the setting screen by pressing the **Jog key**.

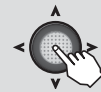

Common function

● Select the item with the **Jog key**.

TRIM	STEP	TYPE
1:AIL ▶	4	NOR
2:ELE ▶	4	NOR
3:THR ▶	4	ATL
4:RUD ▶	4	NOR

(Trim step rate)

TRIM (Besides THR) NOR ⇔ CNT

CNT: With the center trim feature, trim adjustments have no effect on the maximum servo travel. This prevents the linkages from binding when adjustments are made.

THR TRIM ATL ⇔ NOR

ATL: With the ATL trim feature, trim adjustments have no effect on the high throttle. This prevents the linkages from binding when adjustments are made.

● For example, when the step size is the initial value (4), trim movement from center to end is 30 steps. If the step size is made 40, the trim moves 3 steps.

Trim step

① Select the trim you want to set from the **STEP** item and set the step size by pressing the **+ key** or **- key**.

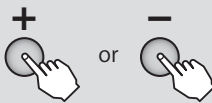

Range : 1-40

Default : 4

● When you want to return the set value to the initial value, press the **+ key** and **- key** simultaneously.

Trim type

① Select the trim you want to set from the **TYPE** item and set the trim type by pressing the **+ key** or **- key**.

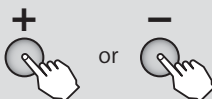

**Range : NOR,
CNT(Besides THR),
ATL (THR)**



SUB TRM Sub trim

(Common)

Function

The Sub-Trim function is used to set the servo neutral position, and may be used to make fine adjustments to the control surface after linkages and pushrods are hooked up. When you begin to set up a model, be sure that the digital trims are set to their center position.

Setting precautions

If sub trim is too large, the servo operating range may be exceeded at maximum control surface angle and generate a dead band in which the servo does not operate. First connect the linkage so that the amount of sub trim used is held to a minimum.

Method

Calling the setting screen

① Call the menu screen from the home screen by pressing the **+** key for 1 second.



② Select **"SUB TRM"** from the menu with the **Jog** key.

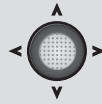

③ Open the setting screen by pressing the **Jog** key.



● Select the channel with the **Jog** key.

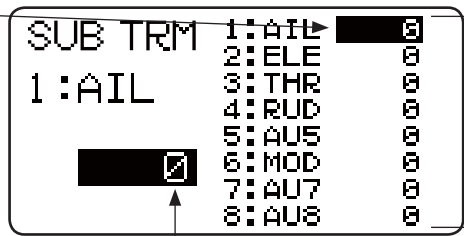

● SUB trim rate of each channel.

SUB trim rate of the selected channel.

< ChannelDisplay >

AIRPLANE (2AIL1FLP)	HELICOPTER	GLIDER (2AIL2FLP)	MULTICOPTER
1: AIL (Aileron1)	1: AIL (Aileron)	1: AIL (Aileron1)	1: AIL (Aileron)
2: ELE (Elevator)	2: ELE (Elevator)	2: ELE (Elevator)	2: ELE (Elevator)
3: THR (Throttle)	3: THR (Throttle)	3: FL3 (Flap3)	3: THR (Throttle)
4: RUD (Rudder)	4: RUD (Rudder)	4: RUD (Rudder)	4: RUD (Rudder)
5: FLP (Flap)	5: GYR (GYRO)	5: FL5 (Flap5)	5: AUX
6: AI6 (Aileron6)	6: PIT (Pitch)	6: AI6 (Aileron6)	6: MOD (Mode)
7: AUX	7: AUX	7: AUX	7: AUX
8: AUX	8: AUX	8: AUX	8: AUX

Sub trim

① Select the SUB trim you want to set from channel item and set the rate by pressing the **+** key or **-** key.



Range :
-120 to +120%
Default : 0%

● When you want to return the set value to the initial value, press the **+** key and **-** key simultaneously.



REVERS Servo reverse

(Common)

Function

Servo reversing (REVERSE): changes the direction an individual servo responds to a CONTROL STICK motion.

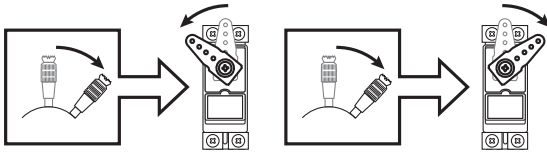

For CCPM helicopters, be sure to read the section on SWASH AFR before reversing any servos.

With the exception of CCPM helicopters, always complete your servo reversing prior to any other programming.

When using AIRPLANE/GLIDER functions that control multiple servos, such as 2AIL or V-TAIL, it may be confusing to determine whether the servo needs to be reversed or a setting in the function needs to be reversed. Refer to the instructions for each specialized function for further details.

CAUTION

- ❗ Only the throttle channel (CH3) initial setting is REV (reverse). Thoroughly check the Hi and Low directions of the engine or motor used and be careful that they do not suddenly run at full speed.
- ❗ Since the direction of the ailerons of an airplane can be easily mistaken, be very careful.

Method

Calling the setting screen

① Call the menu screen from the home screen by pressing the **+** key for 1 second.



② Select **"REVERS"** from the menu with the **Jog** key.

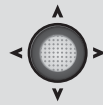

③ Open the setting screen by pressing the **Jog** key.



Common function

To prevent erroneous setting, after the servo reverse screen was called as described above, the channel will not be selected if the Jog key is not pressed at the left and right.

Channel select

- Select the channel with the **Jog** key.

REVERSE

A	E	T	R	A	M	A	A
I	L	H	U	U	O	U	U
REV							
NOR							
	1	2	3	4	5	6	7 8

- The currently selected channel is highlighted.
- Display Reverse/Normal
REV : Reverse
NOR : Normal
 (Channel number)

Servo Reverse

① Channel is Select by **Jog** key.



Selection range :
CH1-8

② NOR or REV is chosen by **Jog** key.



- The confirmation message **"sure?"** blinks on the screen. (Not displayed if the same as before.)

③ Reverse the servo by pressing the **Jog** key.

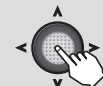

- A confirmation beeping sounds and the direction of operation is reversed.

For safety, a double setting system is used. When a change is cancelled after the confirmation message is displayed, the change is not made when moved to another setting item by Jog key.



PRMTR Parameter function

(Common)

Function

PARAMETER submenu: sets those parameters you would likely set once, and then not disturb again.

Once you have selected the correct model you wish to work with, the next step is setting up the proper parameters for this specific model:

LCD contrast (CONTRAST)

Contrast adjustment LCD screen.

- You adjust to legible contrast. set up range -10 to +10

Back light (BACK-LIT)

Back light mode of a LCD screen can be chosen.

- ON / KEY-ON (Shines for a definite period of time after key operation.) / OFF

Light time (LIT-TIME)

Sets the length of time the backlight will stay on.

- Set up range 1-30

Light adjustment (LIT-ADJS)

Light volume adjustment of a back light.

- Set up range 1-30

Battery alarm (BATT ALM)

Select the battery alarm voltage according to the battery to be used.

- 4 dry cell batteries ⇒ **4.2V DR**
- HT5F1800B (NiMH battery) ⇒ **5.0V Ni**
- FT2F2100BV2 (Lithium ferrite battery) ⇒ **5.8V Fe**

Battery alarm vibration (BATT VIB)

Battery alarm is told with vibration.

Buzzer tone (BUZ-TONE)

The tone of buzzer sound when a key is pressed.

- Set up range : OFF,1(low)-100(high)

Home display (HOME-DSP)

Item selection displayed on a home screen

- **Futaba** logo (Default), **TIMER**, **U-NAME**, **RX BAT** (Case of T-FHSS Air mode.)

Telemetry mode setting (TLM MODE)

Sets whether or not telemetry is activated. When using 2 receivers with 1 transmitter, select INH.

- Range : ACT / INH

Telemetry display units setting (UNIT)

Sets whether the telemetry display is in meters or yards/pounds.

- Range : METER / YARD (°C / °F)

Speech language setting (SPEECH)

Sets the speech language when listening to telemetry information through earphones.

- Range : Japanese (ニホンゴ), English (Englis)

Speech volume setting (VOLUME)

Sets the volume when listening to telemetry information through earphones.

- Range : LOW / HIGH

Stick position alarm setting (STK ALRM)

Can be set so that an audible alarm sounds once when the throttle stick reaches the set position.



Method

Calling the setting screen

① Call the menu screen from the home screen by pressing the **+** key for 1 second.



② Select **"PRMTR"** from the menu with the **Jog** key.

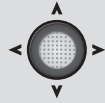

③ Open the setting screen by pressing the **Jog** key.

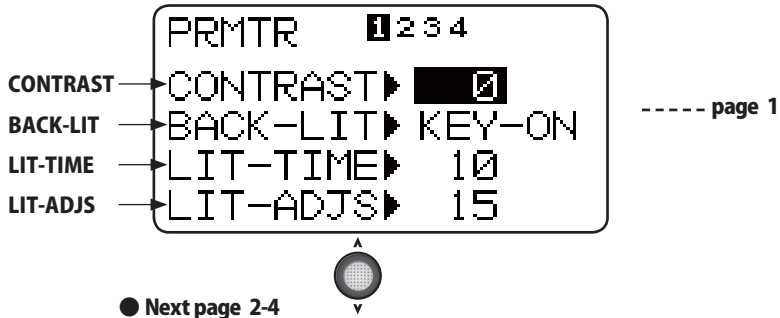

----- page 1

Battery alarm (BATT ALM)

Battery alarm vibration (BATT VIB)

Buzzer tone (BUZ-TONE)

Home display (HOME-DSP)

Telemetry mode (TLM MODE)

Telemetry unit (UNIT)

Speech language (SPEECH)

Speech volume (VOLUME)

Stick position alarm (STK ALRM)

----- page 2

----- page 3

----- page 4

LCD contrast

① Select the **"CONTRAST"** item and change numerical value (contrast) by pressing the **+** key or **-** key.

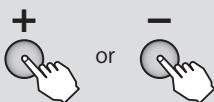

Selection range : -10 to +10

Default : 0



Back-light / Light-time / Light-adjustment

■ Back-light mode

Select the "BACK-LIT" item and change the mode by pressing the **+ key** or **- key**.



- "ON" : always ON
- "OFF" : always OFF
- "KEY-ON" : It light on after Key operation.

Selection range :
ON, OFF, KEY-ON

■ Light-time

Select the "LIT-TIME" item and change numerical value (time) by pressing the **+ key** or **- key**.

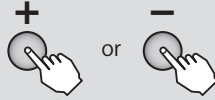

- It is only a case in "KEY-ON" mode here.

Selection range : 1-30(s)
Default : 10(s)

- When you want to return the set value to the initial value, press the **+ key** and **- key** simultaneously.

■ Light-adjustment

Select the "LIT-ADJS" item and change numerical value (brightness) by pressing the **+ key** or **- key**.

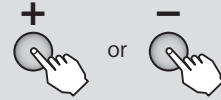

- It is the brightest at 30.

Selection range : 1-30
Default : 15

- When you want to return the set value to the initial value, press the **+ key** and **- key** simultaneously.

Battery alarm voltage

- ① Select the "BATT ALM" item and change the numerical value (voltage) by pressing the **+ key** or **- key**.

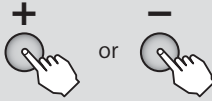

- AA alkaline batteries ⇒ **4.2V DR**
- Futaba HT5F1800B ⇒ **5.0V Ni**
- Futaba FT2F2100BV2 ⇒ **5.8V Fe**

Selection range :
4.2V 4.6V 5.0V 5.4V 5.8V
6.2V 6.6V 7.0V 7.4V

*The voltage drop of a rechargeable battery and a dry cell battery is different. When using a rechargeable battery, always change the voltage.

Battery alarm voltage vibration

- ① Select the "BATT VIB" item and change the ON or OFF by pressing the **+ key** or **- key**.



- ON ⇒ The battery alarm of a transmitter is told with vibration.

Selection range :
ON, OFF

Buzzer tone

- ① Select the "BUZ-TONE" item and change the numerical value (tone) by pressing the **+ key** or **- key**. The higher the numerical value the higher the tone.



Selection range :
OFF, 1-100

- When you want to return the set value to the initial value, press the **+ key** and **- key** simultaneously.



Home display

- ① Select the **"HOME-DSP"** item and change the mode by pressing the + key or – key.



- **"Futaba"** : Display about a Futaba logo.
- "TIMER"** : Display about the timer.
- "U-NAME"** : Display about a user name.
- "RX BAT"** : Display about the receiver battery voltage. (Only T-FHSS Air mode)

Selection range :
Futaba, TIMER, U-NAME,
RX BATT

Default : Futaba

Jog key UP/DOWN

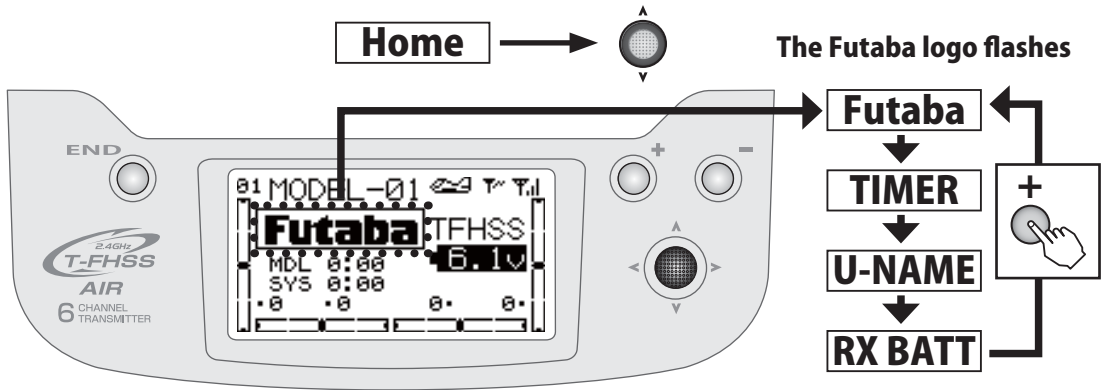

Common function

Telemetry mode

- ① Select the **"TLM MODE"** item and change the mode by pressing the + key or – key.

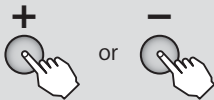

Selection range :
ACT, INH

Telemetry unit

- ① Select the **"UNIT"** item and change the mode by pressing the + key or – key.



Selection range :
METER, YARD

Speech language

- ① Select the **"SPEECH"** item and change the language by pressing the + key or – key.

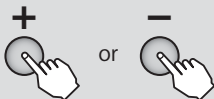

Selection range :
Japanese, English



Speech volume

- ① Select the "SPEECH-VOLUME" item and change the volume by pressing the **+** key or **-** key.



Selection range :
HIGH, LOW

Stick position alarm

An alarm (single beep) can be sounded at the specified throttle stick position.

- Alarm function ON/OFF can be set by switch.

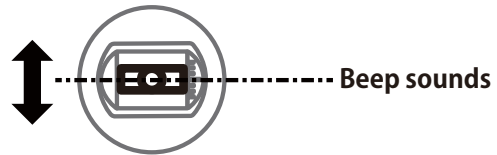

Select "Parameter"

Press the Jog key to the side and select page 4.

- Select the item with the Jog key.

(STK POSI ALRM)

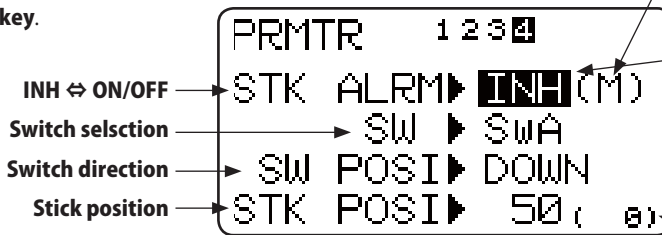

When the THR stick is set to the specified position.

- **Parameter** setting is not reset. However, STK POSI ALRM, and the Telemetry mode on which (M) was displayed are resettable.

- When INH is selected, the function cannot be used. When ON or OFF is selected, the function is activated. ON and OFF changes are linked to the switch.

- The number in parenthesis is the current throttle stick position.

- ① Stick position is chosen by Jog key.

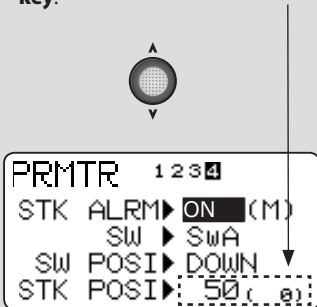

- ② Set the throttle stick to the position at which you want to generate the alarm.

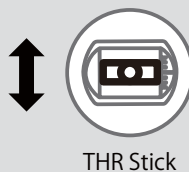

THR Stick

- ③ When the Jog key is held down the alarm sounds at that position.



Memorize the position at which the beep is to sound.



P.MIX

Program mixing

(Common)

Function

Mixing that can independently customize 4 functions can be used. Programmable mixing is used to remove bad tendencies of the aircraft and make operation pleasant. In addition to mixing between arbitrary channels, trim addition, offset, and switch setting functions.

P.MIX 1-3 (normal type)

The following functions can be set for programmable mixing 1 to 3:

【Mixing Channel】

- Use this function by changing the channel because the master channel and slave channels initial setting is a temporary combination.
- When OFS was selected as the master channel, the mixing rate setting applies to slave only. When a mixing rate is set, slave servo operation is offset by that amount.
- A VR as well as a channel, can be selected as the master channel.

【Trim selection】

- Whether or not mixing includes master channel trim operation can be selected.

【Mixing reference point change】

- The master channel mixing reference point can be shifted.

【Switch selection】

- The programmable mixing ON/OFF switch can be selected. The switches that can be selected are switches A to D and the throttle stick.
- The switch operating direction can be set. When a 2 position switch was selected, up /down can be set, and when a 3 position switch was selected, up/up and down /up / and center/center/center and down /down can be selected. When the throttle stick was selected, the ON/OFF position and operation direction can be set. When "NULL" is selected, mixing is always ON.

P. MIX 4 (curve type)

Programmable mix 4 allows setting of the mixing rate by 5 point curve.

OFS and VR use and trim selection by normal type master channel setting described above are impossible, but switch selection is possible.

Method

Calling the setting screen

- ① Call the menu screen from the home screen by pressing the **+** key for 1 second.



- ② Select **"P.MIX"** from the menu with the **Jog** key.

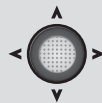

- ③ Open the setting screen by pressing the **Jog** key.





P.MIX Selection

■ Calling the setting screen

- Use the **Jog key** to select the P.MIX number you want to use.
- Call the setting screen by pressing the **Jog key**.

- **P.MIX 1-3** (normal type)
- **P.MIX 4** (curve type)

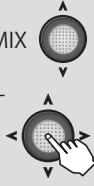

(P.MIX 1-3)

P.MIX

NOR: 1 ▶ **AIL→RUD**

2 ▶ INH

3 ▶ INH

CRV: 4 ▶ RUD→AIL

to P.MIX 1-3 set up screen

to P.MIX 4 set up screen

(P.MIX1-3 set up screen)

P.MIX1

RATE▶ 0% MIX▶ INH

OFFST▶ 0% TRM▶ OFF

(0%)

MASTR▶ AIL SW▶ SWA

SLAVE▶ RUD POSI▶ NULL

Mixing rate adjustment

Offset

Master CH selection

Slave CH selection

Function activation

- When INH is selected, the function cannot be used. When ON or OFF is selected, the function is activated. ON and OFF changes are linked to the switch.

Trim ON/OFF

Switch selection

Switch direction

● Select the item with the **Jog key**.

(Master CH Current position)

P.MIX1-3

■ Function activation

- Select the MIX item and select ON or OFF by pressing the **+ key** or **- key**.

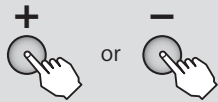

- When you do not want to use the function select INH.

■ Master/Slave channel selection

- Select the MASTR channel you want to use by pressing the **+ key** or **- key**.
- Select the Slave channel you want to us by pressing the **+ key** or **- key**.

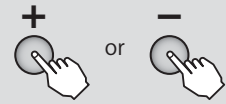

- A VR as well as channels 1 to 6, can be specified as the master channel. In addition, when OFS was selected as the master channel, slave servo operation is offset.

■ Mixing rate adjustment

- Select the RATE item and adjust the mixing rate by pressing the **+ key** or **- key** for each direction of the stick, etc. selected at the master channel.

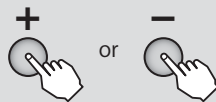

Range : -100 to +100%
Default : 0%

- When you want to return the set value to the initial value, press the **+ key** and **- key** simultaneously.

(Changing the ON/OFF Switch)

■ ON/OFF Switch selection

- Select the "SW" item and then select the switch by pressing the **+ key** or **- key**.



Selection range : SwA-SwD
THR

■ Switch ON direction setting

- Select the "POSI" item and select the switch ON direction by pressing the **+ key** or **- key**.

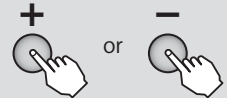

- 2P SW : **NULL (always ON), UP, DOWN**
- 3P SW : **NULL (always ON), UP, UP&DN, UP&CT, CENTR, CT&DN, DOWN**

- THR stick: Hold the stick at the ON/OFF point and set the ON/OFF position by pressing the **Jog key** for 1 second. (If the **Jog key** is pressed for 1 second when the position was set, it returns to the NULL state.) The switch ON direction can also be selected by pressing the **+ key** or **- key**.



(Changing the mixing reference point)

■ **Mixing reference point setting**

- ① Select the "OFFST" item and hold the master side stick or VR in the position you want to set and set the new reference point by pressing the **Jog key**.



Range : -100 to +100%
(THR only 0-100%)

Default : 0%

(Including trim operation)

■ **Trim ON/OFF setting**

- ① Select the "TRM" item and select ON or OFF by pressing the **+ key** or **- key**.

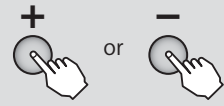

Range : OFF, ON

Default : OFF

- When you do not want to include trim in mixing select OFF.

CAUTION

- At the end of setting, check that the mixing function is performed normally.

Common function

(P.MIX4 set up screen)

- Select the item with the **Jog key**.



5Point curve setting

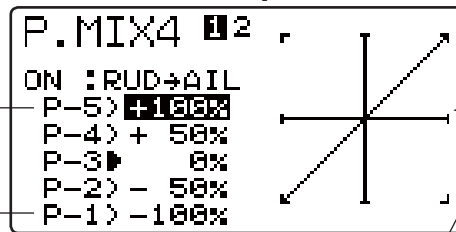

- The set curve is displayed on a graph.

Function activation
Master CH select
Slave CH select

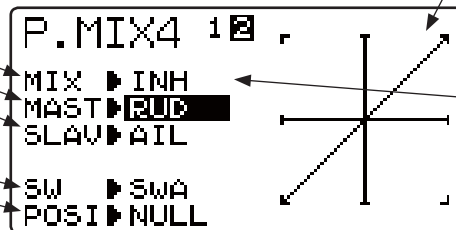

- When INH is selected, the function cannot be used. When ON or OFF is selected, the function is activated. ON and OFF changes are linked to the switch.

P.MIX4

Refer to the P.MIX1-3 setting method described previously for settings other than the 5 point curve setting described below.

■ **5point curve setting**

- ① Select the setting item (P-1 to P-5) of each point with the **Jog key** and set the amount of movement of each point by pressing the **+ key** or **- key**.

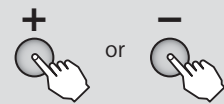

Range : -100 to +100%

Default : 0%

CAUTION

- At the end of setting, check that the mixing function is performed normally.



AUX CH

AUX Channel

(Common)

Function

Auxiliary channel function (AUX CH): defines the relationship between the transmitter controls and the receiver output for channels 5-8.

⚠ Remember that if you assign primary control of a channel to a switch which you later use for other functions (like dual/triple rates or airbrakes), every time you use that other function you will also be moving the auxiliary channel.

Method

Calling the setting screen

① Call the menu screen from the home screen by pressing the **+** key for 1 second.



② Select **"AUX CH"** from the menu with the **Jog** key.

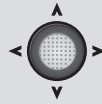

③ Open the setting screen by pressing the **Jog** key.

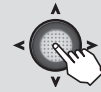

● Select the item with the **Jog** key.

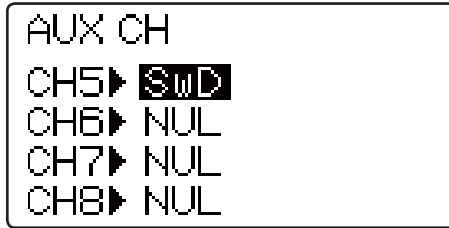

Common function

AUX Channel

① A channel is chosen by **Jog** key.



Selection range : CH5-8

② Select the **"SW"** item and then select the switch by pressing the **+** key or **-** key.

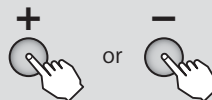

Selection range : NUL, SwA-SwD, VR



SERVO Servo monitor / Servo test (Common)

Function

The servo display/servo test function displays the CH1 to CH8 servo output bar graph and tests servo operation.

- The servo display function can be used for a simple operation check of such functions as the mixing function.
- When the servo test function is turned on, the servo moves to the left and right at the set period. A

variable speed LNR (linear) mode or fixed speed JMP (jump) mode can be selected. This can be used to check the servo, etc. Operation ON/OFF can also be selected for each channel.

CAUTION

- ⚠ Using the servo test will move the servos to their full throw. Do not use this with linkages installed. Using it may damage the servo and linkage.

Method

Calling the setting screen

① Call the menu screen from the home screen by pressing the **+** key for 1 second.



② Select **"SERVO"** from the menu with the **Jog** key.

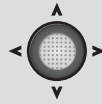

③ Open the setting screen by pressing the **Jog** key.

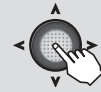

Common function

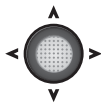

- Select the setting item with the **Jog** key.

(Servo Monitor)

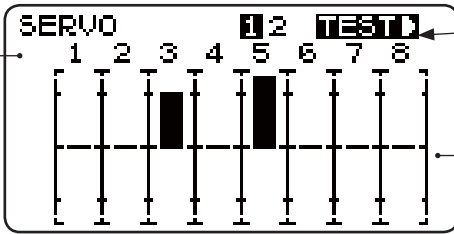

- Switching to the servo test screen
- Switch the screen by selecting **TEST** and operating the jog key to the left and right.
- The servo operating position of each channel is displayed on a bar graph.

(Servo Test)

Servo test ON/OFF

Channel Select

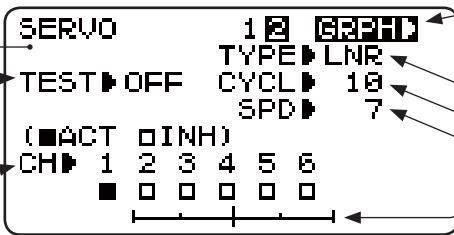

- Screen change
- Where **"GRPH"** is chosen, a **Jog** key is pressed in right or left.
- Type Select
- Cycle Select
- Speed setting
- Operation of a servo test

Servo test

■ Type/cycle/speed setting

① Select the setting item (TYPE, CYCL, SPD) with the Jog key and set the item by pressing the **+** key or **-** key.

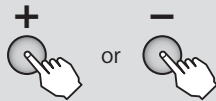

(Range / Default)

TYPE : **LNR, JMP** / LNR

CYCL : **1-100** / 10 (full speed at 1)

SPD : **1-100** / 7 (full speed at 100)

■ Channel selection

② Select the channel you want to test with the **Jog** key and select ACT/INH by pressing the **+** key or **-** key.



Selection range : **ACT, INH**

Default : **INH** (only CH1 is ACT)

■ Servo test start/stop

③ Select the **"TEST"** item with the **Jog** key and start/stop the servo test by pressing the **+** key or **-** key.

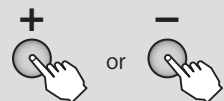

Selection range : **ON, OFF**
Default : **OFF**



TLMTRY Telemetry (Common)

Function

This screen displays and sets the various information from the receiver. An alarm and vibration can be generated depending on the information. For example, a drop in the voltage of the receiver battery housed in the aircraft can be reported by an alarm.

- This function can only be used in the T-FHSS Air mode. The S-FHSS system cannot use telemetry.
- Telemetry sensors sold separately can be mounted in the aircraft to display a variety of information. (Receiver voltage does not require a sensor.)
- The telemetry function cannot be used if the telemetry mode of the parameters is not ACT.
- When 2 receivers are used with 1 transmitter, the telemetry function cannot be used.

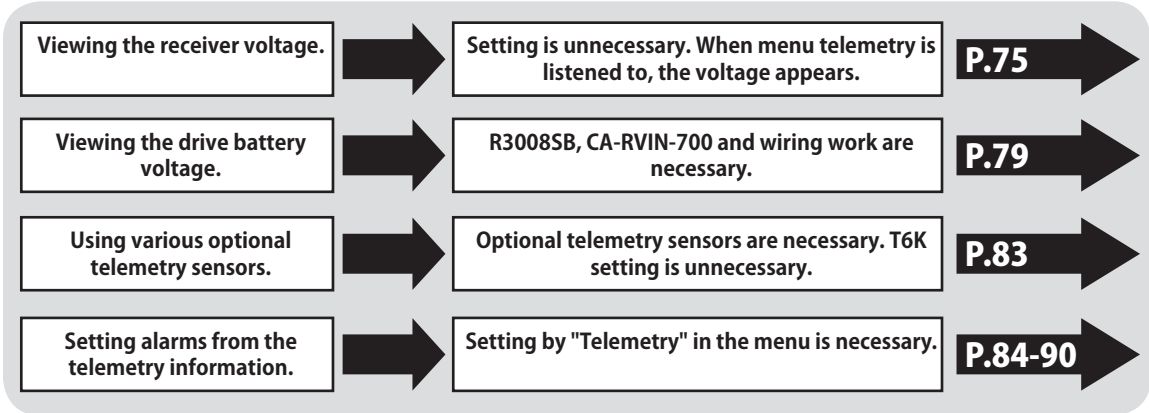

Common function

RX-BATT

- **Viewing the receiver voltage.**
In the initial state, the receiver voltage is displayed at the transmitter.

Display

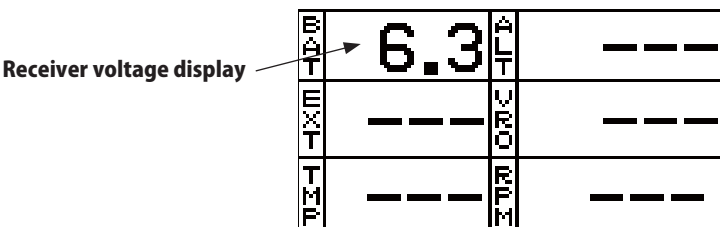
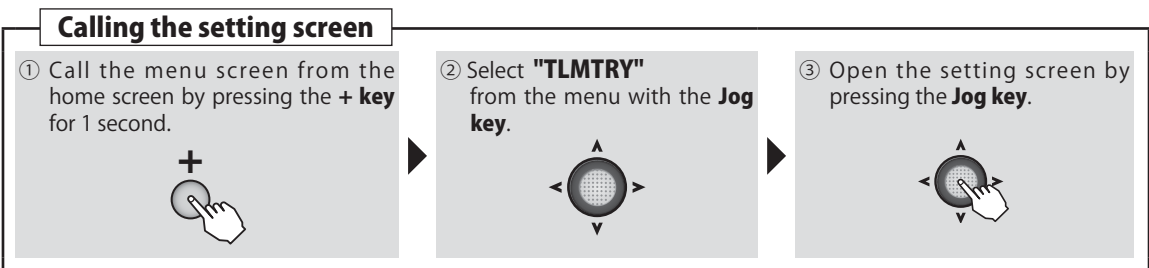

- How to display receiver voltage on a home screen.
PARAMETER
↓
HOME-DSP
↓
"RX BATT" is chosen by + key or - key.



● Viewing the receiver voltage maximum and minimum values.

In the initial state, the receiver voltage maximum and minimum values are displayed in the transmitter. (Value until reset)

Display

Calling the setting screen

① Select "RX-BATT" from the telemetry screen with the **Jog key**.



② Open the setting screen by pressing the **Jog key**.



Receiver voltage MIN

Receiver voltage display

Receiver voltage MAX

```

RX-BATT
MIN/MAX= 6.3V / 6.3V
(ALARM) (VIB) (LIMIT)
DN▶ INH ▶OFF ▶ 5.0V
SPEECH▶ INH SW▶ NULL
  
```

MIN/MAX reset

① Select "MIN/MAX" from the RX-BATT screen with the **Jog key**.



② Date reset by pressing the **Jog key** for 1 second.



- A confirmation "beep" sounds when complete.

Common function

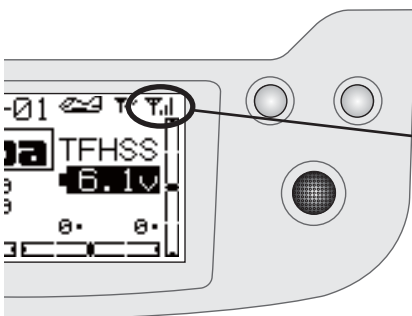

- Receiver → Transmitter. The reception of the signal from the receiver to the transmitter is shown. This does not affect flight.

⚠ WARNING

- ⊘ Do not stare at or set the transmitter setting screen while flying.
 - Losing sight of the aircraft during flight is very dangerous.
 - When you want to check the information during flight, call the telemetry screen before flight and have the screen checked by someone other than the operator.



● Setting receiver voltage alarm.

Use this setting to sound an alarm when the receiver battery voltage drops dangerously low. VIB (vibration) that vibrates the transmitter at the same time can also be set.

Method

Calling the setting screen

① Select "RX-BATT" from the telemetry screen with the **Jog key**.



② Open the setting screen by pressing the **Jog key**.



DN (down) shows that an alarm is generated when the voltage drops below the set voltage.

```

RX-BATT                               6.3V
MIN/MAX= 6.3V / 6.3V
(ALARM) (VIB) (LIMIT)
DN INH OFF 5.0V
SPEECH INH SW NULL
    
```

Alarm set

① In the RX-BATT screen state, select (ALARM) from the menu with the **Jog key**.

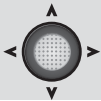

② Select the "ACT" by pressing the **+ key** or **- key**.

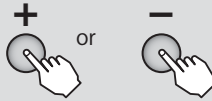

Vibration set

① In the RX-BATT screen state, select (VIB) from the menu with the **Jog key**.



② Select the "TYP1-TYP3" by pressing the **+ key** or **- key**.

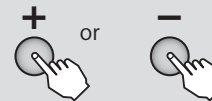

"VIB" types

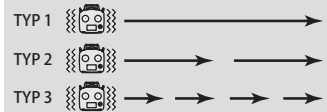

Alarm voltage set

① In the RX-BATT screen state, select (LIMIT) 0.0V from the menu with the **Jog key**.

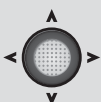

② Select the voltage by pressing the **+ key** or **- key**.

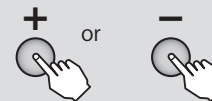

Selection range :
3.5V-8.4V

● When you want to set 5.0V, press the **+ key** and **- key** simultaneously.



● Listening to the receiver voltage by speech.

The receiver voltage can be heard verbally from the transmitter with a commercial earphone (3.5 φ plug). The speech function can be turned on and off with the specified switch.

Method

Calling the setting screen

① Select "RX-BATT" from the telemetry screen with the **Jog key**.



② Open the setting screen by pressing the **Jog key**.



```

RX-BATT
                                6.3V
MIN/MAX= 6.3V/ 6.3V
(ALARM) (VIB) (LIMIT)
DN▶ INH ▶OFF ▶ 5.0V
SPEECH▶ INH SW▶ NULL
  
```

Speech
ACT/INH

Selects the switch
that turns the speech
function on and off.

Common function

Speech

① In the RX-BATT screen state, select (SPEECH) from the menu with the **Jog key**.

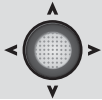

② Select the "ACT" by pressing the **+ key** or **- key**.

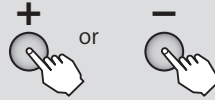

Switch

① In the RX-BATT screen state, select (SW) from the menu with the **Jog key**.

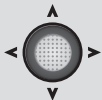

In "NULL", a speech always turns on.

② Select the switch by pressing the **+ key** or **- key**.

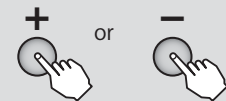

Selection range :
NULL, SWA-SWD

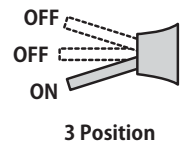
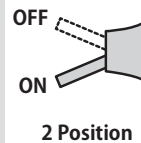



EXT-VOLT

When connected as shown in the figure, the voltage of the drive battery in the aircraft and another power supply battery can be displayed at the T6K.

- **R3008SB Receiver, CA-RVIN-700** (external voltage input cable sold separately) is necessary.
- Soldered wiring work is necessary.

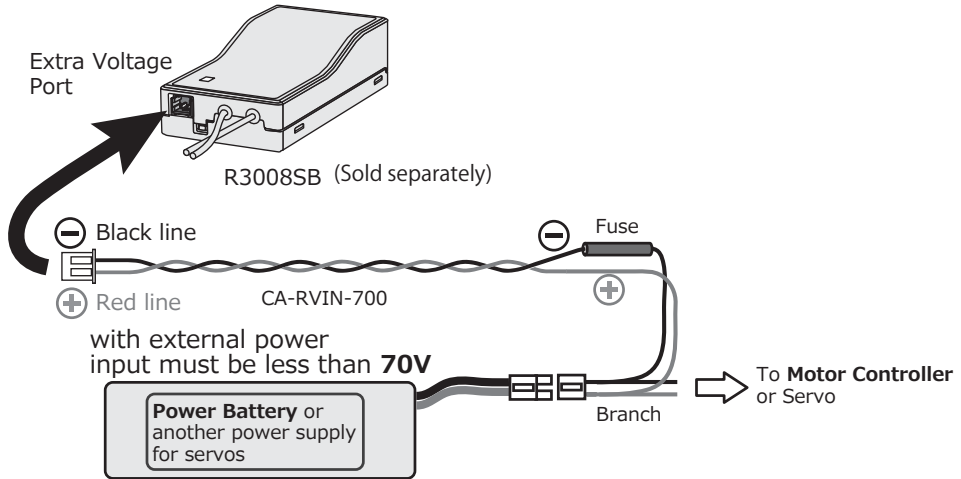

● EXT-Voltage display

When connected as shown in the figure, the drive battery voltage is displayed at the transmitter.

Method

Calling the SENSOR screen

- Call the menu screen from the home screen by pressing the **+ key** for 1 second.
- Select **"SENSOR"** from the menu with the **Jog key**.
- Open the setting screen by pressing the **Jog key**.

EXT start

- In the **SENSOR** screen state, select **"EXT ▶ OFF"** from the menu with the **Jog key**.
- Select the **"R3008SB"** by pressing the **+ key** or **- key**.

SENSOR Screen

SENSOR		1 2
TEMP ▶	SBS-01T/TE	
RPM ▶	SBS-01RB/O/M	
ALTI ▶	SBS-01A/02A	
CURR ▶	SBS-01C	
EXV ▶	SBS-01V	
EXT ▶	R3008SB	



Display

Calling the setting screen

① Call the menu screen from the home screen by pressing the **+** key for 1 second.



② Select **"TELEMETRY"** from the menu with the **Jog key**.

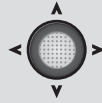

③ Open the setting screen by pressing the **Jog key**.

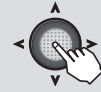

EXT-Voltage display

EXT-VOLT	6.3	---
EXT-VOLT	0.0	---
EXT-VOLT	---	---

● EXT-Voltage MIN/MAX

In the initial state, the EXT-voltage maximum and minimum values are displayed at the transmitter. (Value until reset)

Common function

Calling the setting screen

① Select **"EXT-VOLT"** from the telemetry screen with the **Jog key**.



② Open the setting screen by pressing the **Jog key**.



EXT-Voltage MIN

EXT-Voltage display

EXT-Voltage MAX

EXT-VOLT	8.8V
MIN/MAX=	8.8V / 8.8V
(ALARM) (VIB) (LIMIT)	
DN ▶ INH ▶ OFF ▶	5.8V
SPEECH ▶ INH SW ▶	NULL

MIN/MAX reset

① In the **EXT-VOLT** screen state, select **(MIN/MAX)** from the menu with the **Jog key**.



② Date reset by pressing the **Jog key** for 1 second.



- A confirmation "beep" sounds is complete.



● EXT-Voltage alarm set up

This setting will sound an alarm when the EXT-voltage drops dangerously low. VIB (vibration) that vibrates the transmitter at the same time can also be set.

Method

Calling the setting screen

① Select "EXT-VOLT" from the telemetry screen with the **Jog key**.



② Open the setting screen by pressing the **Jog key**.



```
EXT-VOLT
                8.8V
MIN/MAX= 8.8V/ 8.8V
(ALARM) (VIB) (LIMIT)
DN▶ INH ▶OFF ▶ 5.0V
SPEECH▶ INH SW▶ NULL
```

DN (down) shows that an alarm is generated when the voltage drops below the set voltage.

Alarm set

① In the EXT-VOLT screen state, select (ALARM) from the menu with the **Jog key**.

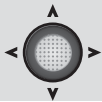

② Select the "ACT" by pressing the **+ key** or **- key**.

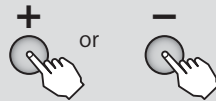

Vibration set

① In the EXT-VOLT screen state, select (VIB) from the menu with the **Jog key**.

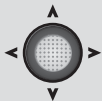

② Select the "TYP1-TYP3" by pressing the **+ key** or **- key**.

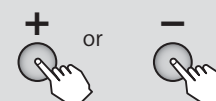

"VIB" types

If the following types are selected, the transmitter will vibrate during the warning.

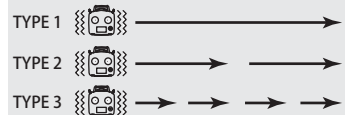

Alarm voltage set

① In the EXT-VOLT screen state, select (LIMIT) from the menu with the **Jog key**.

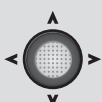

② Select the voltage by pressing the **+ key** or **- key**.

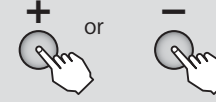

Selection range :

0.0V-70.0V

● When you want to set 5.0V, press the **+ key** and **- key** simultaneously.



● Listening to the EXT-voltage by speech.

The EXT- voltage can be heard verbally from the transmitter with a commercial earphone (3.5mm plug). The speech function can be turned on and off with the specified switch.

Method

Calling the setting screen

① Select "EXT-VOLT" from the telemetry screen with the **Jog key**.



② Open the setting screen by pressing the **Jog key**.



```

EXT-VOLT
          8.8V
MIN/MAX= 8.8V/ 8.8V
(ALARM) (VIB) (LIMIT)
DN INH OFF 5.8V
SPEECH INH SW NULL
  
```

Speech
ACT/INH

Speech ON/OFF Switch
selection

Common function

Speech

① In the EXT-VOLT screen state, select (**SPEECH**) from the menu with the **Jog key**.

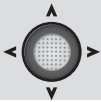

② Select the "ACT" by pressing the **+** key or **-** key.

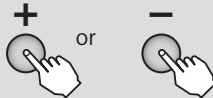

Switch set

① In the EXT-VOLT screen state, select (**SW**) from the menu with the **Jog key**.

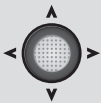

In "NULL", a speech always turns on.

② Select the switch by pressing the **+** key or **-** key.

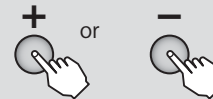

Selection range :
NULL, SWA-SWD

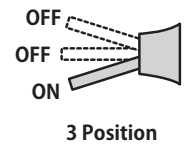
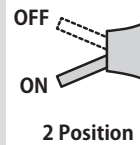



Various telemetry sensors (optional) information display and alarm setting

Various telemetry sensors (sold separately) are connectable to the S.BUS2 port of the R3006SB through a 3-way hub and relay terminals. The information of sensors connected at initialization can be viewed as long as 2 or more of the same kind of sensor are not used (for example, 2 temperature sensors).

- Sensors that can be used with the T6K: Futaba SBS-01T/TE, SBS-01RM, SBS-01RO, SBS-01A/02A, SBS-01C, SBS-01V
- Robbe sensors that can be used with the T6K: Robbe TEMP125, VARIO-1712, VARIO-1672 (Setting change is needed in a SENSOR screen.)

*Futaba does not sell Robbe sensor.

Sensor Connection

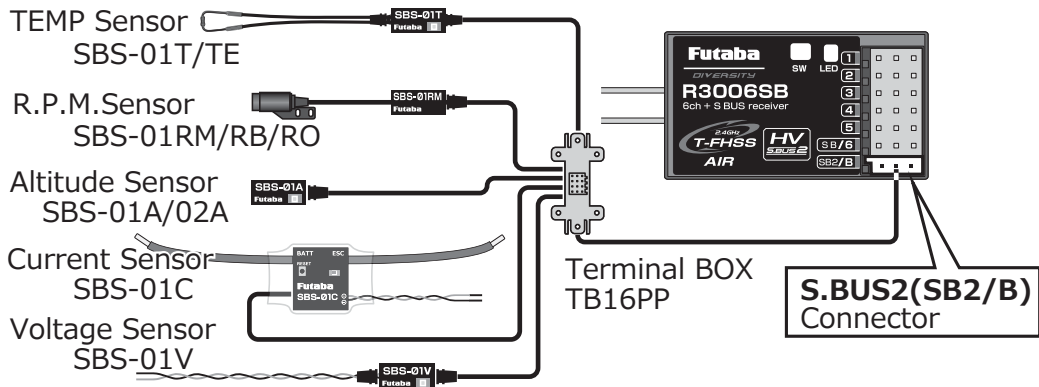

*Refer to the manual of each sensor for the mounting instruction to the model of sensor.

Method

Sensor information can be viewed by calling telemetry from the menu and calling the connected sensor display page. The detailed setting screen of that sensor can be called by selecting and pressing the sensor you want to select with the Jog key.

- Refer to the receiver battery (RX-BATT) item for a description of key operation.

- ① Select "TELEMETRY" from the menu with the **Jog key**.

BATT	6.3	TEMP	0
EXT	0.0	RPM	0
ALT	37	VAR	1995

- ② The sensor item of your choice is chosen by **Jog key**, and **Jog key** is pressed.

BATT	6.3	TEMP	0
EXT	0.0	RPM	0
ALT	37	VAR	1995

↓
Sensor set up



TEMP : Display of SBS-01T/TE(Optional), and alarm setup

*A temperature sensor must be installed in the aircraft.

TEMP is a screen which displays/sets up the temperature information from an optional temperature sensor.

The temperature of the model (engine, motor, battery etc.) which is flying can be displayed.

If it becomes higher or lower than the setting an alarm and/or vibration will ALARM you.

- Conversion of a display unit is performed by "TLM UNIT" of "PARAMETER".

- Select [TMP] in the TELEMETRY screen and access the setup screen shown below by pressing the Jog key.

- "UP" will show that an alarm will start when the temperature rises above the set value.

- "DN" will show that an alarm will start when the temperature drops below the set value.

- You can hear the temperature through an earphone or headset, by activating the Speech function.

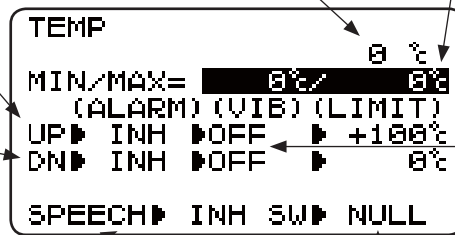

- Temperature

- The maximum and the minimum when powering ON are shown.

- Maximum and minimum date reset by pressing the **Jog key** for 1 second.

"VIB" type

If the following types are selected, the transmitter will vibrate during the warning.

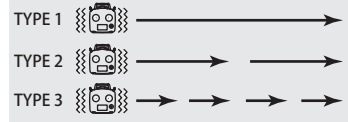

- Switch selection

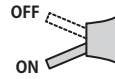

2 Position

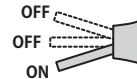

3 Position

ALARM set : Hot warning

1. Move the cursor to the UP:(ALARM) item.
2. Select the ACT mode by press the +-key.
3. Move the cursor to the UP:(LIMIT)[value]item.
4. Adjust the rate by press the +-key.
Initial value: +100°C
Adjustment range: -20°C to 200°C
(UP:(LIMIT) ≥ DN:(LIMIT))

*When the + - keys are pressed simultaneously, the rate is reset to the initial value.

(To terminate the input and return to the original state, touch the END key.)

ALARM set : Low-temperature warning

1. Move the cursor to the DN:(ALARM) item.
2. Select the ACT mode by press the +-key.
3. Move the cursor to the DN:(LIMIT)[value]item.
4. Adjust the rate by press the +-key.
Initial value: 0°C
Adjustment range: -20°C to 200°C
(UP:(LIMIT) ≥ DN:(LIMIT))

*When the + - keys are pressed simultaneously, the rate is reset to the initial value.

(To terminate the input and return to the original state, touch the END key.)



R.P.M : Display of SBS-01RM/RO/RB (Option), and alarm setup

*A RPM sensor must be installed in the aircraft.

RPM is a screen which displays / sets up the RPM information from an optional RPM sensor.

The RPM of the model (engine, motor, etc.) which is flying can be shown.

If it becomes higher or lower than the setting an alarm and/or vibration will ALARM you.

- Select [RPM] in the TELEMETRY screen and access the setup screen shown below by pressing the Jog key.

- UP: Indicates that the alarm will start when the RPM rises above the set value.
- DN: Indicates that the alarm will start when the RPM falls below the set value.

- You can hear the RPM data through an ear-phone or headset, by Activating the Speech function.

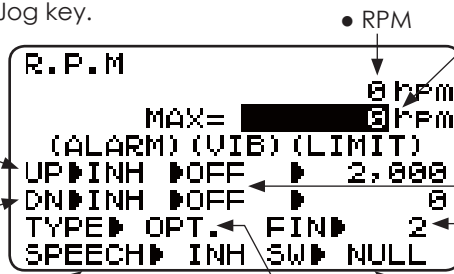

- "MAG.(MAGNETIC)" or "OPT.(OPTICAL)" is set according to the sensor you use.

SBS-01RM, RB : MAGNETIC
SBS-01RO : OPTICAL

- Switch selection

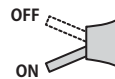

2 Position



3 Position

- The maximum when powering ON are shown.
- Maximum date reset by pressing the Jog key for 1 second.

"VIB" type

If the following types are selected, the transmitter will vibrate during the warning.

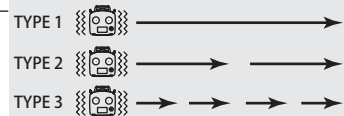

- In "OPTICAL", the number of blades("FIN") of the propeller (r o t o r) your model is entered.
- In "MAGNETIC", the gear ratio of your engine (motor) you are using is entered.

ALARM set : Over rotations

1. Move the cursor to the UP:ALARM item.
2. Select the ACT mode by press the +-key.
3. Move the cursor to the UP:(LIMIT) [value]item.
4. Adjust the rate by press the +-key.
Initial value: 2000rpm
Adjustment range: 0rpm-390,000rpm
(UP:(LIMIT) \geq DN:(LIMIT))

*When the +- keys are pressed simultaneously, the rate is reset to the initial value.

(To terminate the input and return to the original state, touch the END key.)

ALARM set : Under rotations

1. Move the cursor to the DN:ALARM item.
2. Select the ACT mode by press the +-key.
3. Move the cursor to the UP:(LIMIT) [value]item.
4. Adjust the rate by press the +-key.
Initial value: 0rpm
Adjustment range: 0rpm-390,000rpm
(UP:(LIMIT) \geq DN:(LIMIT))

*When the +- keys are pressed simultaneously, the rate is reset to the initial value.

(To terminate the input and return to the original state, touch the END key.)



ALTITUDE : Display of SBS-01A/02A (Option), and alarm setup

*An altitude sensor must be installed in the aircraft.

ALTITUDE is a screen which displays / sets up the altitude information from an optional altitude sensor. The altitude of the model which is flying can be known. If it becomes higher (low) than preset altitude, you can be told by alarm. To show warning by vibration can also be chosen. Data when a power supply is turned on shall be 0 m, and it displays the altitude which changed from there. Even if the altitude of an airfield is high, that shall

be 0 m and the altitude difference from an airfield is displayed. This sensor calculates the altitude from atmospheric pressure. Atmospheric pressure will get lower as you go up in altitude, using this the sensor will estimate the altitude. Please understand that an exact advanced display cannot be performed if atmospheric pressure changes in a weather situation.

● Conversion of a display unit is performed by "TLM UNIT" of "PARAMETER".

● Select [ALTITUDE] in the TELEMETRY screen and access the setup screen shown below by pressing the Jog key.

● The maximum and the minimum when powering ON are shown.
● Maximum and minimum data reset by pressing the Jog key for 1 second.

● "UP" indicates the alarm will start when the altitude reaches above your set value.

● "DN" indicates the alarm will start when the altitude reaches below your set value.

● You can hear the Altitude data through an ear-phone or headset, by Activating the Speech function.

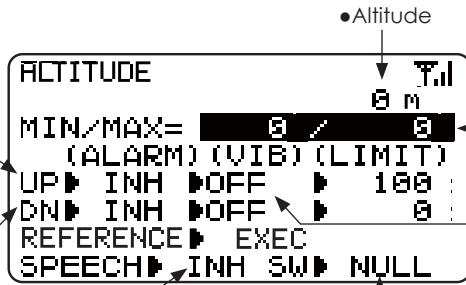

● Switch selection

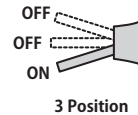
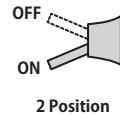

"VIB" type

If the following types are selected, the transmitter will vibrate during the warning.

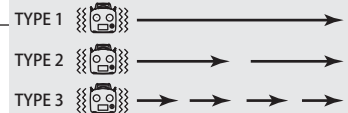

First, the set of a reference is required.

1. The model and transmitter to which the altitude sensor was connected are turned on.
2. Move the cursor to the [REFERENCE] of "EXEC" item.
3. Press the Jog key (1s or more press).

*Atmospheric pressure is changed according to the weather also at the same airfield. You should preset before a flight.

ALARM set : High side

1. Move the cursor to the UP:(ALARM) item.
2. Select the ACT mode by press the +-key.
3. Move the cursor to the UP:(LIMIT)[value]item.
4. Adjust the rate by press the +-key.
Initial value: +200(m)
Adjustment range: -500 to +5000(m)
(UP:(LIMIT) ≥ DN:(LIMIT))

*When the + - keys are pressed simultaneously, the rate is reset to the initial value.

(To terminate the input and return to the original state, touch the END key.)

ALARM set : Low side

1. Move the cursor to the DN:(ALARM) item.
2. Select the ACT mode by press the +-key.
3. Move the cursor to the UP:(LIMIT)[value]item.
4. Adjust the rate by press the +-key.
Initial value: -50(m)
Adjustment range: -500 to +5000(m)
(UP:(LIMIT) ≥ DN:(LIMIT))

*When the + - keys are pressed simultaneously, the rate is reset to the initial value.

(To terminate the input and return to the original state, touch the END key.)



VARIO : Display of SBS-01A/02A (Option), and alarm setup

*An altitude sensor must be installed in the aircraft.

VARIO is a screen which displays / sets up the variometer information from an optional altitude sensor.

The variometer of the model which is flying can be known.

If it becomes higher or lower than the setting an alarm and/or vibration will ALARM you.

● Conversion of a display unit is performed by "TLM UNIT" of "PARAMETER".

● Select [VARIO] in the TELEMETRY screen and access the setup screen shown below by pressing the Jog key.

● The maximum and the minimum when powering ON are shown.

● Maximum and minimum date reset by pressing the **Jog key** for 1 second.

● "UP" indicates the alarm will start when the vario reaches above your set value.

● "DN" indicates the alarm will start when the vario reaches below your set value.

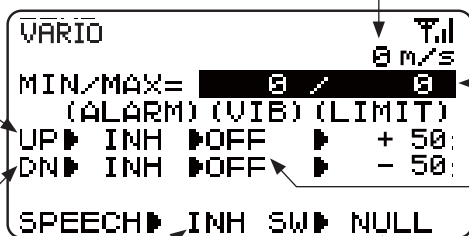

● You can hear the Vario data through an ear-phone or headset, by Activating the Speech function.

● Switch selection

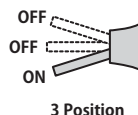
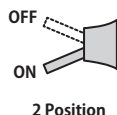

"VIB" type
If the following types are selected, the transmitter will vibrate during the warning.

TYPE 1 →

TYPE 2 →

TYPE 3 →

Common function

ALARM set : Rise side

1. Move the cursor to the UP:(ALARM) item.
2. Select the ACT mode by press the +key.
3. Move the cursor to the UP:(LIMIT)[value]item.
4. Adjust the rate by press the +-key.
Initial value: +50(m/s)
Adjustment range: -150 to +150(m/s)
(UP:(LIMIT) ≥ DN:(LIMIT))

*When the + - keys are pressed simultaneously, the rate is reset to the initial value.

(To terminate the input and return to the original state, touch the END key.)

ALARM set : Low side

1. Move the cursor to the DN:(ALARM) item.
2. Select the ACT mode by press the +key.
3. Move the cursor to the UP:(LIMIT)[value]item.
4. Adjust the rate by press the +-key.
Initial value: -50(m/s)
Adjustment range: -150 to +150(m/s)
(UP:(LIMIT) ≥ DN:(LIMIT))

*When the + - keys are pressed simultaneously, the rate is reset to the initial value.

(To terminate the input and return to the original state, touch the END key.)



CURRENT : Display of SBS-01C (Option), and alarm setup

*A current sensor must be installed in the aircraft.

CURRENT is a screen which displays / sets up the current information from an optional current sensor.

The current of the battery which is flying can be known.

If it becomes higher or lower than the setting an alarm and/or vibration will ALARM you.

● Conversion of a display unit is performed by "TLM UNIT" of "PARAMETER".

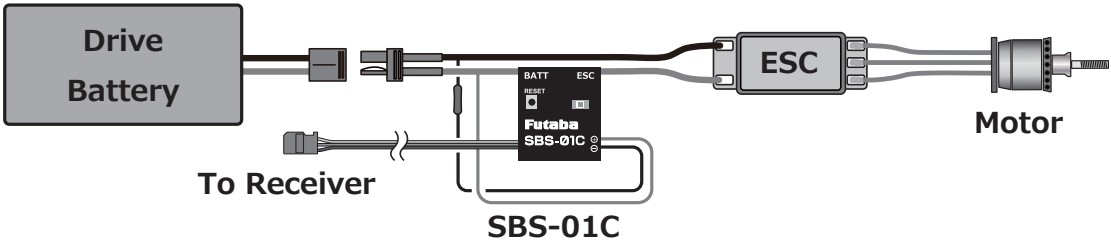

Common function

● Select [CURRENT] in the TELEMETRY screen and access the setup screen shown below by pressing the Jog key.

● The maximum and the minimum when powering ON are shown.

● Maximum and minimum date reset by pressing the Jog key for 1 second.

● "UP" indicates the alarm will start when the current reaches above your set value.

● "DN" indicates the alarm will start when the current reaches below your set value.

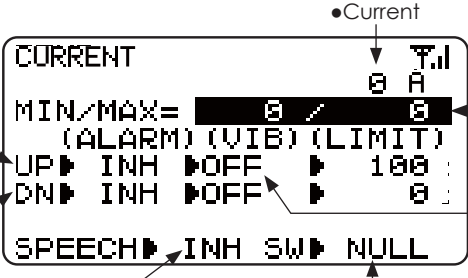

"VIB" type
If the following types are selected, the transmitter will vibrate during the warning.

TYPE 1 → → → →

TYPE 2 → → → →

TYPE 3 → → → →

● You can hear the current data through an ear-phone or headset, by Activating the Speech function.

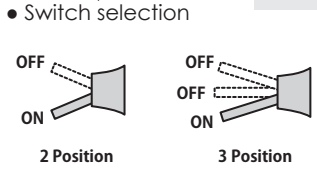

ALARM set : Up side

1. Move the cursor to the UP:(ALARM) item.
2. Select the ACT mode by press the +-key.
3. Move the cursor to the UP:(LIMIT)[value]item.
4. Adjust the rate by press the +-key.
Initial value: 100(mAh)
Adjustment range: -150 to +150(mAh)
(UP:(LIMIT) ≥ DN:(LIMIT))

*When the +- keys are pressed simultaneously, the rate is reset to the initial value.
(To terminate the input and return to the original state, touch the END key.)

ALARM set : Down side

1. Move the cursor to the DN:(ALARM) item.
2. Select the ACT mode by press the +-key.
3. Move the cursor to the UP:(LIMIT)[value]item.
4. Adjust the rate by press the +-key.
Initial value: 0(mAh)
Adjustment range: -150 to +150(mAh)
(UP:(LIMIT) ≥ DN:(LIMIT))

*When the +- keys are pressed simultaneously, the rate is reset to the initial value.
(To terminate the input and return to the original state, touch the END key.)



VOLTAGE : Display of SBS-01V (Option), and alarm setup

*A voltage sensor must be installed in the aircraft.

VOLTAGE is a screen which displays / sets up the voltage information from an optional voltage sensor.

The voltage of the battery which is flying can be known.

If it becomes higher or lower than the setting an alarm and/or vibration will ALARM you.

● Conversion of a display unit is performed by "TLM UNIT" of "PARAMETER".

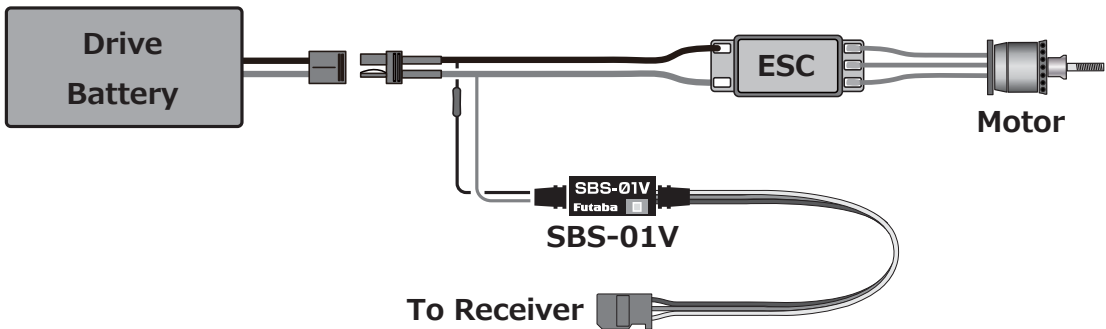

● Select [VOLTAGE] in the TELEMETRY screen and access the setup screen shown below by pressing the Jog key.

● The maximum and the minimum when powering ON are shown.

● Maximum and minimum date reset by pressing the Jog key for 1 second.

VOLTAGE

Voltage

0.0 V

MIN/MAX= 0.0V / 0.0V

(ALARM) (VIB) (LIMIT)

DN INH OFF 0.0V

SPEECH INH SW NULL

"VIB" type

If the following types are selected, the transmitter will vibrate during the warning.

TYPE 1

TYPE 2

TYPE 3

● "DN" indicates the alarm will start when the voltage reaches below your set value.

● You can hear the current data through an ear-phone or headset, by Activating the Speech function.

● Switch selection

OFF

ON

2 Position

OFF

OFF

ON

3 Position

Common function

ALARM set : Down side

1. Move the cursor to the DN:(ALARM) item.
2. Select the ACT mode by press the +-key.
3. Move the cursor to the UP:(LIMIT)[value]item.
4. Adjust the rate by press the +-key.
Initial value: 0(V)
Adjustment range: 0-100(V)

*When the + - keys are pressed simultaneously, the rate is reset to the initial value.

(To terminate the input and return to the original state, touch the END key.)



CAPACITY : Display of SBS-01C (Option), and alarm setup

*A current sensor must be installed in the aircraft.

CAPACITY is a screen which displays / sets up the consumption capacity information from an optional current sensor.

The consumption capacity of the battery which is flying can be known.

If it becomes higher or lower than the setting an alarm and/or vibration will ALARM you.

● Conversion of a display unit is performed by "TLM UNIT" of "PARAMETER".

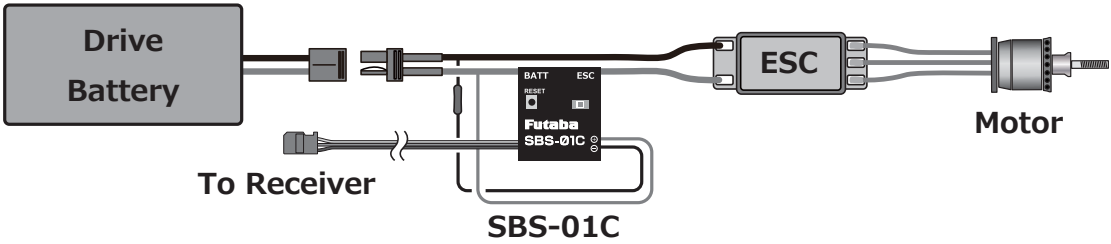

Common function

● Select [CAPACITY] in the TELEMETRY screen and access the setup screen shown below by pressing the Jog key.

● The maximum and the minimum when powering ON are shown.

● Maximum and minimum date reset by pressing the Jog key for 1 second.

● Consumption capacity

● "UP" indicates the alarm will start when the capacity reaches above your set value.

● "DN" indicates the alarm will start when the capacity reaches below your set value.

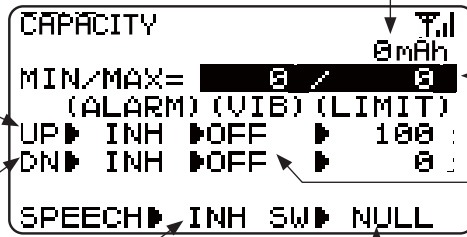

"VIB" type
If the following types are selected, the transmitter will vibrate during the warning.

TYPE 1 → → → →

TYPE 2 → → → →

TYPE 3 → → → →

● You can hear the current data through an ear-phone or headset, by Activating the Speech function.

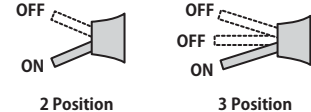

ALARM set : Up side

1. Move the cursor to the UP:(ALARM) item.
2. Select the ACT mode by press the +-key.
3. Move the cursor to the UP:(LIMIT)[value]item.
4. Adjust the rate by press the +-key.
Adjustment range: -32000 to +32000(mAh)
(UP:(LIMIT) ≥ DN:(LIMIT))

*When the +- keys are pressed simultaneously, the rate is reset to the initial value.
(To terminate the input and return to the original state, touch the END key.)

ALARM set : Down side

1. Move the cursor to the DN:(ALARM) item.
2. Select the ACT mode by press the +-key.
3. Move the cursor to the DN:(LIMIT)[value]item.
4. Adjust the rate by press the +-key.
Adjustment range: -32000 to +32000(mAh)
(UP:(LIMIT) ≥ DN:(LIMIT))

*When the +- keys are pressed simultaneously, the rate is reset to the initial value.
(To terminate the input and return to the original state, touch the END key.)



SENSOR Sensor (Common)

Function

This screen registers the telemetry sensors used with the transmitter. When a Futaba SBS-01T/E, SBA-01RO/RM/RB, SBS-01A/02A, SBS-01C and SBS-01V sensor is used, this setting is unnecessary and the sensor can be used by simply connecting it to the S.BUS2 port of the receiver.

When using a sensor to which the slot number was changed by other transmitters or Robbe sensor (TEMP125, VARIO-1712, 1672), they must be registered here.

[What is a slot?]

Servos are classified by CH, but **sensors** are classified in units called "slots". There are **slots** from **No. 1** to **No. 31**. **Altitude sensors** units may use **multiple slots**. T6K can use 1 of sensor respectively. Any more sensor can't be used.

Method

Calling the setting screen

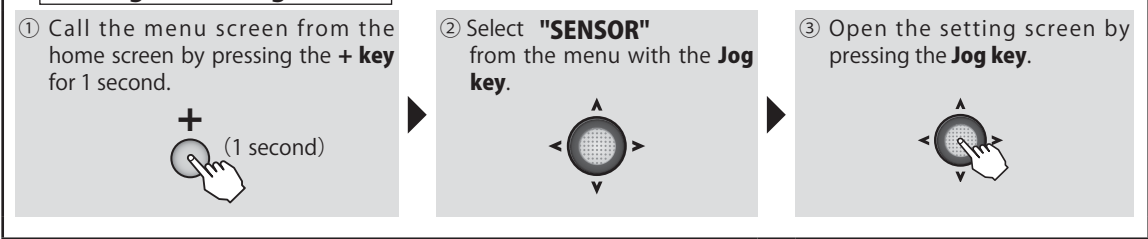

Change the sensor

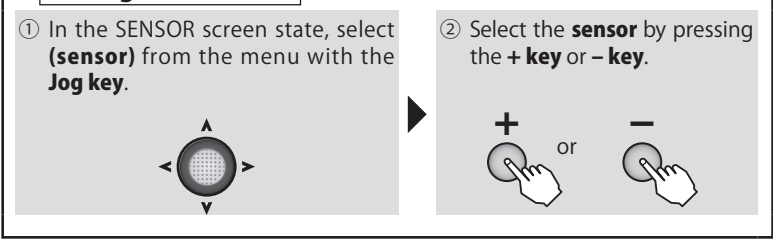

● The "SENSOR" of a menu is chosen, and **Jog key** press.

● The kind of sensors.

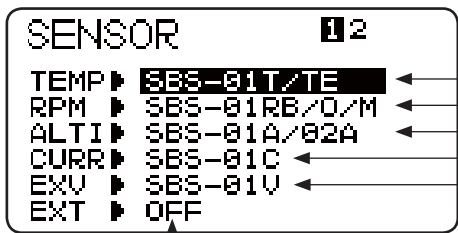

- SBS-01T, SBS-01TE is used.
- SBS-01RO, SBS-01RM, SBS-01RB is used.
- SBS-01A, SBS-02A is used.
- SBS-01C is used.
- SBS-01V is used.

● OFF → R3008SB : EXT battery voltage can be indicated.

● **R3008SB Receiver, CA-RVIN-700** (external voltage input cable sold separately) is necessary.

● Soldered wiring work is necessary.

Common function



● **REGISTER (When using sensor to which the slot number was changed by other transmitters.)**

This function resets a starting slot of a sensor and registers with a transmitter.

Connect the sensor as shown in the figure and register it by the following procedure.

Sensor connect

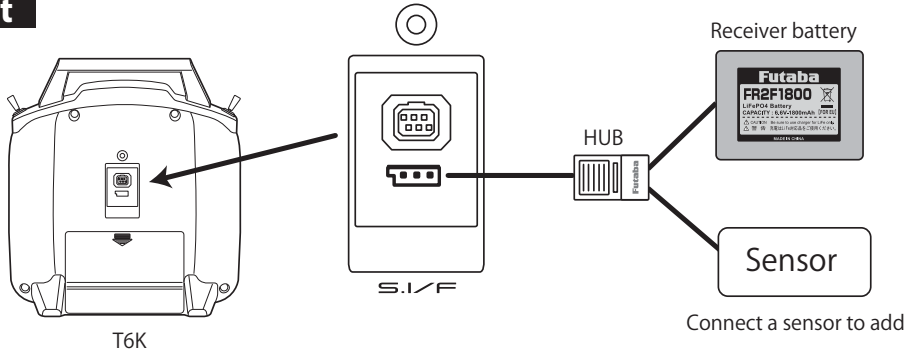

Method

Calling the setting screen

① Call the menu screen from the home screen by pressing the **+ key** for 1 second.



② Select **"SENSOR"** from the menu with the **Jog key**.

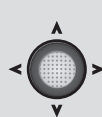

③ Open the setting screen by pressing the **Jog key**.

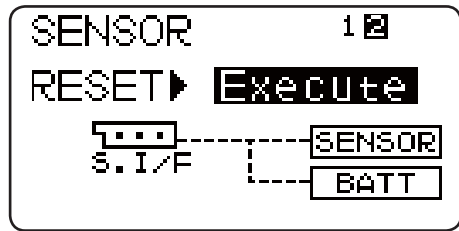
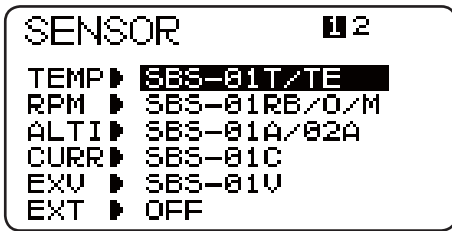

Common function

Sensor register

① SENSOR page 2 is chosen by **Jog key**.



② Connect a sensor and a battery to the transmitter.

③ Press the **Jog key** for 1 second.



● Confirmation message **"sure?"** blinks.

④ Press the **Jog key**.



● A confirmation **"beep"** sounds when complete.

● **"COMU-ERROR"** : It is failure of register. Check a sensor and connection.



S.BUS

S.BUS servo link

(Common)

Function

An S.BUS(2) servo can memorize the channel and various settings you input. Servo setting can be performed on the T6K screen by wiring the servo as shown in the figure.

- * With some S.BUS(2) servos, there are some functions which cannot be used. If a function cannot be used, the display screen will change. (Only the function which can be used by a servo is displayed.)
- * After reading completion, with connection of the above figure, if a stick is moved, the test of operation of the servo can be operated and carried out.

Method

Calling the setting screen

① Call the menu screen from the home screen by pressing the **+** key for 1 second.



② Select **"S.BUS"** from the menu with the **Jog** key.

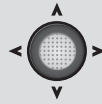

③ Open the setting screen by pressing the **Jog** key.

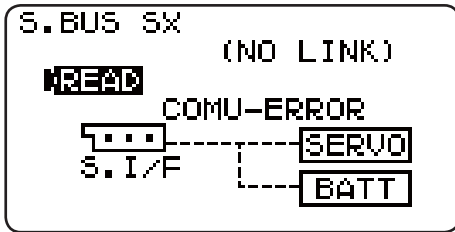

④ Connect a S.BUS servo to set up.

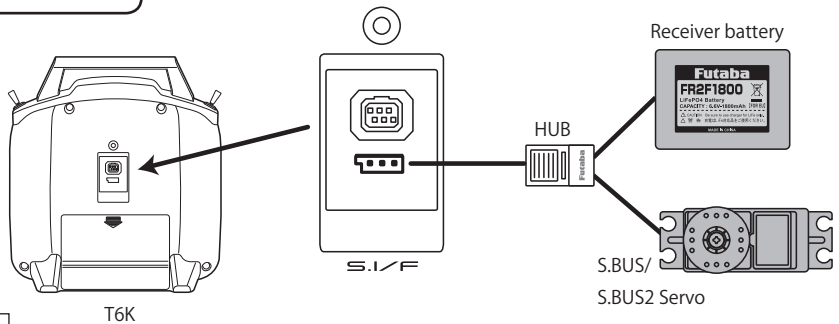

S.BUS Servo setting

⑤ **"READ"** is chosen by **Jog** key, Press the **Jog** key for 1 second.



⑥ READ is completed and the item in which data of S.BUS servo and a setup are possible is displayed.

* **"COMU-ERROR"** :
It is failure of READ. Check a servo and connection.

⑦ S.BUS servo is set up.

⑧ **"WRITE"** is chosen and **Jog** key is pressed for 1 second.



The writing is done when **"Complete"** is shown.

Next page S.BUS servo function

Common function



S.BUS Servo Description of function of each parameter

*There are a function which can be used according to the kind of servo, and an impossible function.

```

S.BUS SX      1 2
ID= 042-00069
READ WRITE RESET
COMPLETE!
CHAN▶ 1  DEAD▶ 0.25
                REVE▶ NORM
NEUT▶ 0.00
EPA▶ 100.0(L/R)100.0

```

```

S.BUS SX      1 2
ID= 042-00069
READ WRITE RESET
STRE▶ 4.0  SPED▶ INH
BOST▶ 10%  STAR▶ INH
DAMP▶ 80   SMOT▶ ON
BSTM▶ OFF

```

ID = [ID]

Displays the ID of the servo whose parameters are to be read. It cannot be changed.

CHAN ▶ [Channel]

Channel of the S.BUS system assigned to the servo. Always assign a channel before use.

NEUT ▶ [Neutral Offset]

The neutral position can be changed. When the neutral offset is large value, the servo's range of travel is restricted on one side.

EPA ▶ [Travel Adjust]

The left and right travels centered about the neutral position can be set independently.

DEAD ▶ [Dead band]

The dead band angle at stopping can be specified.

[Relationship between dead band set value and servo operation]

Small → Dead band angle is small and the servo is immediately operated by a small signal change.

Large → Dead band angle is large and the servo does not operate at small signal changes.

(Note) If the dead band angle is too small, the servo will operate continuously and the current consumption will increase and the life of the servo will be shortened.

REVE ▶ [Reverse]

The direction in which the servo rotates can be changed.

STRE ▶ [Stretcher]

The servo hold characteristic can be set. The torque which attempts to return the servo to the target position when the current servo position has deviated from the target position can be adjusted.

This is used when stopping hunting, etc., but the holding characteristic changes as shown below.

[Relationship between stretcher and servo operation]

Small → Servo holding force becomes weaker.

Large → Servo holding force becomes stronger.

(Note) When this parameter is large, the current consumption increases.



BOST ▶ [Boost]

The minimum current applied to the internal motor when starting the servo can be set. Since a small travel does not start the motor, it essentially feels like the dead band was expanded. The motor can be immediately started by adjusting the minimum current which can start the motor.

[Relationship between boost set value and servo operation]

Small → Motor reacts to a minute current and operation becomes smooth.

Large → Initial response improves and output torque increases. However, if the torque is too large, operation will become rough.

DAMP ▶ [Damper]

The characteristic when the servo is stopped can be set.

When smaller than the standard value, the characteristic becomes an overshoot characteristic. If the value is larger than the standard value, the brake is applied before the stop position.

Especially, when a large load is applied, overshoot, etc. are suppressed by inertia and hunting may occur, depending on the conditions. If hunting (phenomena which cause the servo to oscillate) occurs even though the Dead Band, Stretcher, Boost and other parameters are suitable, adjust this parameter to a value larger than the initial value.

[Relationship between damper set value and servo operation]

Small → When you want to overshoot. Set so that hunting does not occur.

Large → When you want to operate so that braking is not applied. However, it will feel like the servo response has worsened.

(Note) If used in the hunting state, not only will the current consumption increase, but the life of the servo will also be shortened.

BSTM ▶ ON/OFF [Boost ON/OFF]

OFF : It is the boost ON at the time of low-speed operation.(In the case of usual)

ON : It is always the boost ON.(When quick operation is hope)

SPED ▶ [Speed Control]

Speeds can be matched by specifying the operating speed. The speed of multiple servos can be matched without being affected by motor fluctuations. This is effective for load torques below the maximum torque.

However, note that the maximum speed will not be exceed what the servo is capable of even if the servos operating voltage is increased.

STAR ▶ [Soft Start]

Restricts operation in the specified direction the instant the power is turned on. By using this setting, the first initial movement when the power is turned on slowly moves the servo to the specified position.

SMOT ▶ [Smoother]

This function changes smoothness of the servo operation relative to stick movement changes. Smooth setting is used for normal flight. Select the "OFF" mode when quick operation is necessary such as 3D.



M TRANS Model transfer

(Common)

Function

Transmission of model data is possible with T6K transmitters. Data transfer is performed by the radio. The MDL-TRANS function works with the current model you are using in the transmitter. As for the receiving transmitter, any data on the current model that is receiving the information will be over-written.

*T6K does not carry out normal operation during data transfer.

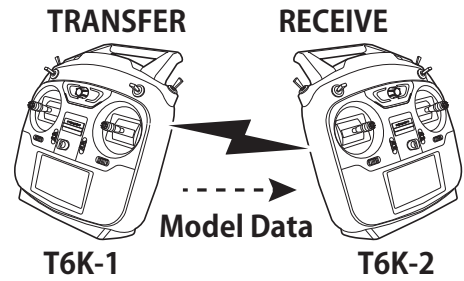

Method

Calling the setting screen

① Call the menu screen from the home screen by pressing the **+ key** for 1 second.



② Select **"M TRANS"** from the menu with the **Jog key**.

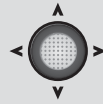

③ Open the setting screen by pressing the **Jog key**.



Common function



Execution of transmission/reception

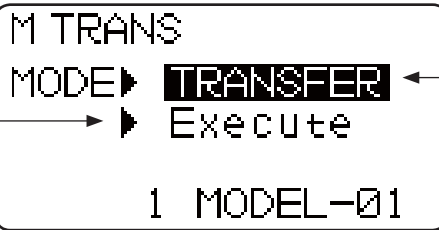

MODE :
TRANSFER (T6K of data origin) /
RECEIVE (T6K which receives data)

Model transfer

● MDL-TRANS between two T6K radios should be performed within 2-meter range.

① In each T6K, the **+ or - key** is pressed and it is made **"TRANSFER"** and **"RECEIVE"**.

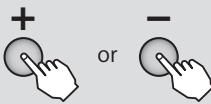

● **"TRANSFER"** : T6K of data origin
"RECEIVE" : T6K which receives data

Selection range : **TRANSFER, RECEIVE**

② Select **"Execute"** with the **Jog key**.



③ Hold down the **Jog key** [each T6K].



● **"Complete"** is displayed and the mode transfer is finished.

CAUTION

⚠ Always check servo direction prior to every flight as an additional precaution to confirm proper model date, hook ups, and radio function.

NOTE: MDL-TRANS between two T6K radios should be performed within a 2-meter range.

● If data is not being transmitted, the receiving transmitter returns to normal operation 10 seconds after execution. At this time, **"Failure"** (not transmitting) is displayed.



TIMER

Timer

(Common)

Function

The timer is convenient during a competition to set the specified amount of time or the flying time on a full tank of fuel.

- The timers can be set for each model. Since the timers can be set to match the model, they do not have to be reset each time the model is changed.
- The type of timer can be selected from among up (UP), down (DOWN), up THR integrate (DN-UP-INT) and down THR integrate (DN-TH-INT). The up timer is counted up from 0 and the elapsed time is displayed on the screen. The down timer is counted down from the set time and the remaining time is displayed on the screen. The down stop timer stops the count at 0. Each timer can be set up to 99

minutes 59 seconds.

- Switches A to D, throttle stick (ST-THR), or power switch (PWR-SW) can be selected as the start/stop switch (START). The ON/OFF direction can also be set. However, when the power switch was selected, the timer starts when the power switch is turned on.
- When the timer you want to reset is selected with the Jog key and the Jog key is pressed for 1 second at the home screen, the timer is reset. Switches A to D can be selected as the reset switch (RESET). The ON/OFF direction can also be set.
- The up/down timer audible alarm indicates the time by a beep every second, continuous beeping at 2 second intervals from 20 seconds before the set time, and a continuous beeping at a 1 second interval from 10 seconds before the set time.

Method

Calling the setting screen

- 1 Call the menu screen from the home screen by pressing the **+ key** for 1 second.



- 2 Select **"TIMER"** from the menu with the **Jog key**.

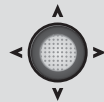

- 3 Open the setting screen by pressing the **Jog key**.



- Select the item with the **Jog key**.

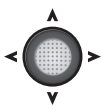

- Time set up
- Mode selection
- ON Switch selection
- Reset Switch selection

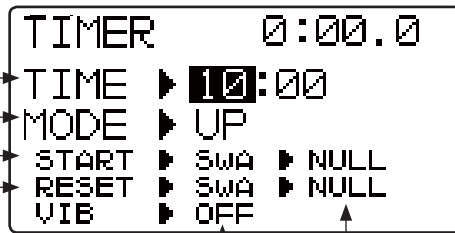

Vibration selection Switch direction

- When the throttle switch is selected at switch selection, hold the throttle stick in the position you want to set the ON/OFF point at ON direction setting and set the ON/OFF position by pressing the Jog key for 1 second. The timer is turned ON at points higher than this position. The ON direction can be switched by pressing the **+ key** or **- key**.

Timer

Mode selection

- 1 Select timer mode from the **"MODE"** with the **+ or - key**.

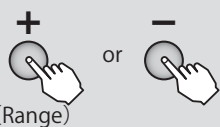

(Range)
UP, DOWN, DN-STP

Timer time setting

- 2 Set the time by pressing the **+ key** or **- key** at each TIME (minutes):(second) item.

(Range)
0-99 minutes 59 seconds

Switch selection and ON direction setting

- 3 Select the switch by pressing the **+ key** or **- key** at the START or RESET item and set the ON direction by pressing the **+ key** or **- key** at the ON direction setting item.

(Switch setting range)

START: SwA-D, THR, PWR

RESET: SwA-D

(Switch ON direction)

3P SW: NULL (normally off), UP, UP&D, UP&C, CNTR, C&DN, DOWN

2P SW: NULL, UP, DOWN

Common function



Vibration set

- ① In the **TIMER** screen state, select **(VIB)** from the menu with the **Jog key**.

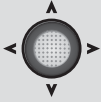

- ② Select the **"TYP1-TYP3"** by pressing the **+ key** or **- key**.

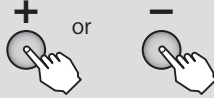

"VIB" types

If the following types are selected, the transmitter will vibrate during the warning.

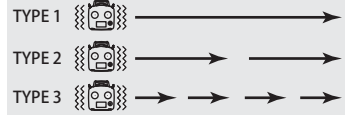

Displaying the timer on the home screen

The set timer can be displayed on the home screen. (When a user name is not set, the Futaba logo is displayed.) When the home screen display is changed to timer by PARAMETER, the set timer is displayed.

Common function

Calling the setting screen

- ① Call the menu screen from the home screen by pressing the **+ key** for 1 second.



- ② Select **"PRMTR"** from the menu with the **Jog key**.

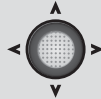

- ③ Open the setting screen by pressing the **Jog key**.



Parameter

- ① Select **"HOME-DSP"** from the parameter 2 page with the **Jog key**.

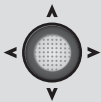

- ② Select **"TIMER"** by pressing the **+ key** or **- key**.



- ③ **End** setting by pressing the **END key**.





Integration Timer (UP-TH-INT, DN-TH-INT)

INT (integration) Timer is the function which changes progress of a timer according to the location of the throttle stick. When the throttle stick is raised for faster speed, the speed of the timer usually increases. With the throttle stick at mid-range speed, the timer speed decreases (to 50%). When the throttle is positioned at low end, the timer's progress stops. It's possible to set it in the time which fits power consumption of your fuselage.

● Alarm (Vib)

The integration Timer audible alarm indicates the time by a beep from 10% and 0% before the set time.

*The consumption of the battery/fuel is different depending on the conditions, so use an INT Timer as reference.

*The INT (integration) time is different from the actual elapsed time.

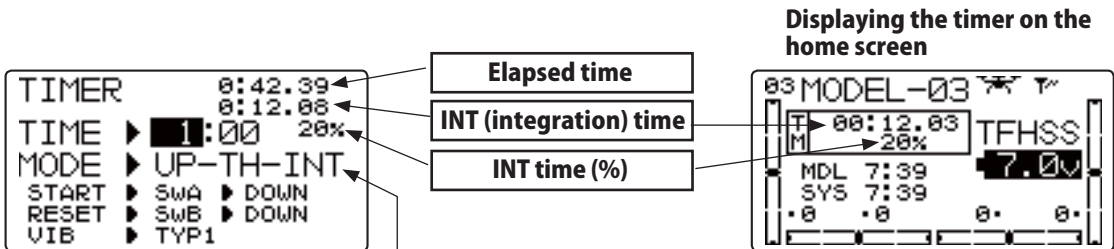
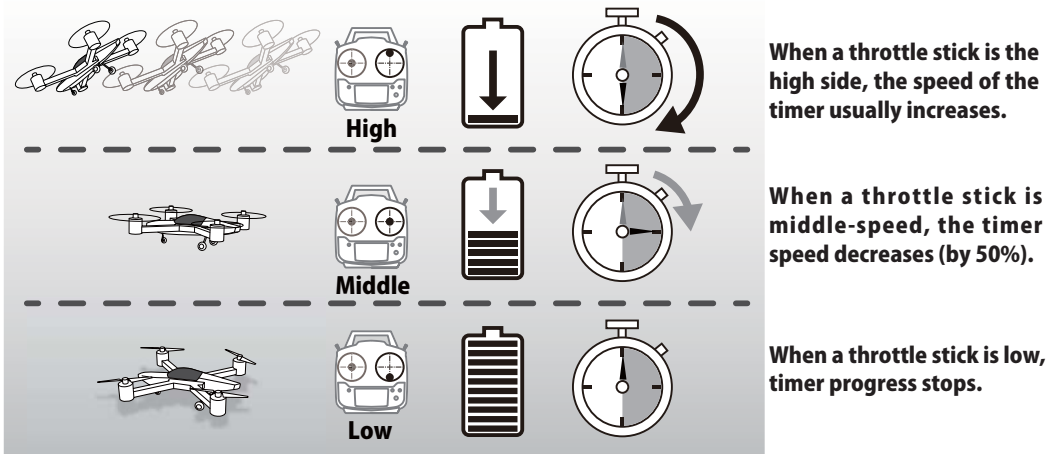

- **UP-TH-INT**: Count up integration timer
- **DN-TH-INT**: Count down integration timer

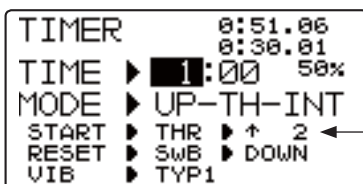

● Example

When it's connected with the throttle stick, a START of a timer can be used more easily.

The setting example which starts an INT timer when a throttle stick exceeds 2%.



TRAINER Trainer

(Common)

Function

Since the channel and operation mode used in training can be selected, the training difficulty can be set to match the student's level.

The trainer function can be used by connecting the instructor's transmitter to the student's transmitter using a special trainer cord (sold separately). Student operation is possible by instructor switch operation. If the student enters a dangerous situation, control can be immediately switched to the instructor.

- Four operation modes can be selected at each channel.
- The trainer switch is set to switch D.

When the trainer function is used, cancel the function assigned to the switch D. THR-HOLD of a helicopter can't be used.

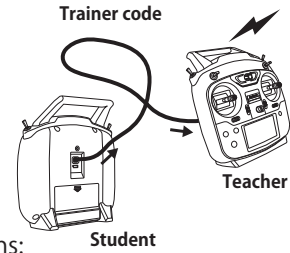

CAUTION

Use the trainer function under the following conditions:

- When the instructor uses a T6K transmitter, set the student's transmitter modulation to PPM (for conventional frequency transmitter). (When the student uses a T6K transmitter, the modulation mode does not have to be changed. A PPM signal is always output from the trainer jack.)
- Before flight always confirm that all the instructor and student channels operate normally as set.
- Always insert the trainer cord as far as it will go and take measures so that the cord will not work loose during use.
- Always remove the high frequency module of the student's transmitter. (For module type)
- Never turn on the student's transmitter power switch.

Trainer function operation modes

- FNC mode: The channel set to this mode can be controlled by the student using the mixing set at the instructor's transmitter. ***Student settings are returned to their initial value in advance. Next, reverse function makes all channels normal.**
- NOR mode: The channel set to this mode is controlled by signals from the student's transmitter. (The instructor and student settings must be the same.)
- OFF mode: The channel set to this mode cannot be controlled by the student. It can only be controlled by the instructor.

However, channels not provided at the student's transmitter are controlled by the instructor regardless of the above settings.

When other models are selected, the trainer function is deactivated, but the channel settings remain.

Example of use

- When the FUNC mode is set at the stick channel, helicopter stick operation training is possible even with a 4EX transmitter (4 channels for aircraft).
- Control by the instructor is possible by setting only the training channel matched to the student's level to the NORM mode and setting the other channels to the OFF mode.

◆ Trainer Cords

Instructor	Student	Trainer Cords
6K	10C, 9C, 7C, 6EX, 4EX	T12FG (FUTM4405)
	18MZ, 18SZ, 14MZ, 14SG, FX-22, 12Z, 12FG, 8FG, 6K , 8J, 6J	T12FG (FUTM4405) and 9C (FUTM4415) Trainer Cords
18MZ, 18SZ, 14MZ, 14SG, FX-22, 12Z, 12FG, 8FG, 10C, 9C, 7C, 8J, 6J, 4EX	6K	



Method

Calling the setting screen

① Call the menu screen from the home screen by pressing the **+ key** for 1 second.



② Select **"TRAINER"** from the menu with the **Jog key**.

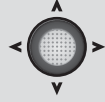

③ Open the setting screen by pressing the **Jog key**.



(Trainer function)

● Select the item with the **Jog key**.

Function activation

Channel Select

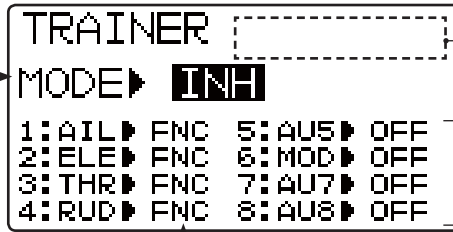

● If a trainer cable was connected, it indicates **"ON LINE"**.

● Channel setting mode display

● Select CH mode Display

< ChannelDisplay >

AIRPLANE (2AIL1FLP)	HELICOPTER	GLIDER (2AIL2FLP)	MULTICOPTER
1: A11 (Aileron1)	1: AIL (Aileron)	1: A11 (Aileron1)	1: AIL (Aileron)
2: ELE (Elevator)	2: ELE (Elevator)	2: ELE (Elevator)	2: ELE (Elevator)
3: THR (Throttle)	3: THR (Throttle)	3: FL3 (Flap3)	3: THR (Throttle)
4: RUD (Rudder)	4: RUD (Rudder)	4: RUD (Rudder)	4: RUD (Rudder)
5: FLP (Flap)	5: GYR (Gyro)	5: FL5 (Flap5)	5: AUX
6: A16 (Aileron6)	6: PIT (Pitch)	6: A16 (Aileron6)	6: MOD (Mode)
7: AUX	7: AUX	7: AUX	7: AUX
8: AUX	8: AUX	8: AUX	8: AUX

Trainer function

■ Function activation

① Select the **"OFF"** by pressing the **+ key** or **- key**.

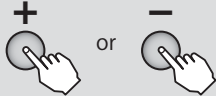

● When you do not want to use the function select INH.

■ Mode setting

② The mode of the channel of hope is chosen by pressing the **+ key** or **- key**.

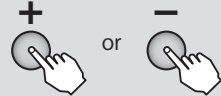

Selection range : **OFF, NOR, FNC**

⚠ The switch D isn't supposed to have the important function about a flight.

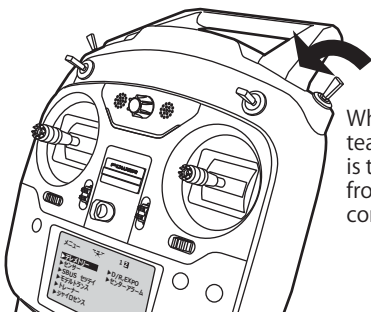

When the switch D of teacher's transmitter is turned on at the front, it'll be student's control.

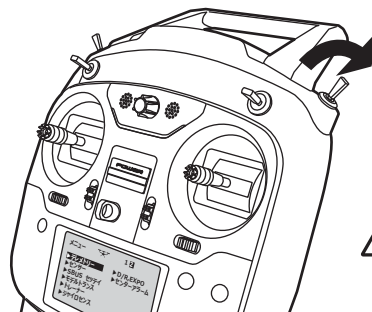

When the switch D of teacher's transmitter is turned off, it'll be teacher's control.

⚠ The switch D isn't the return switch, so be careful.



Airplane Function

The setting screen of each function is called from the following menu. The function when the model type was set to airplane (AIRPLANE) is displayed here.

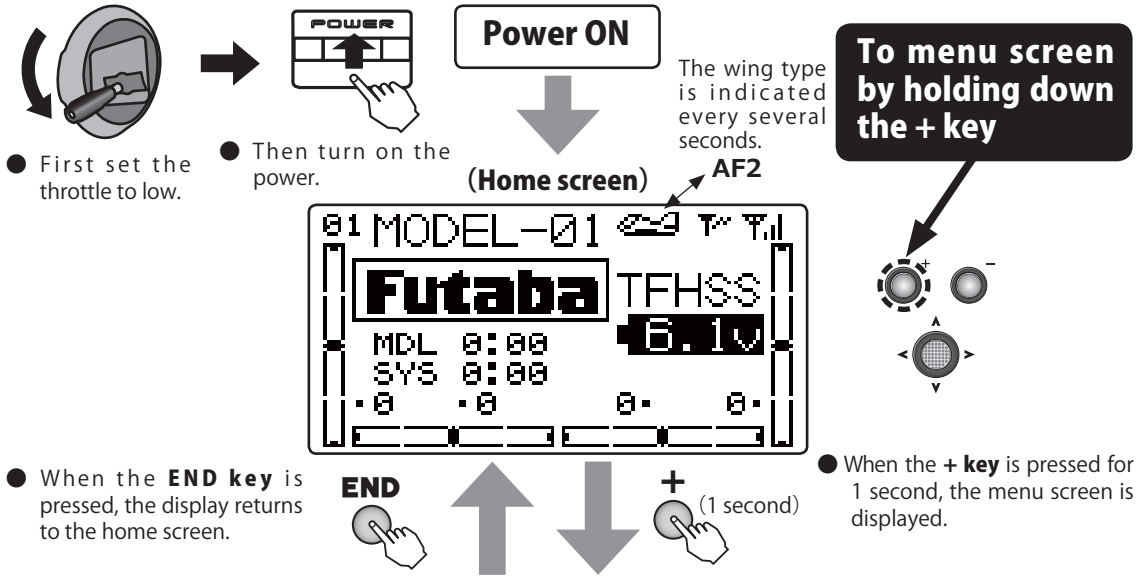

MENU

MENU 1/4

MENU 1 2 3 4

- ▶ MDL SEL ▶ E POINT
- ▶ MDL TYP ▶ TRIM
- ▶ MDL NAM ▶ SUB TRM
- ▶ F/S ▶ REVERS

MENU 2/4

MENU A-1 1 2 3 4

- ▶ PRMTR ▶ TLMTRY
- ▶ P. MIX ▶ SENSOR
- ▶ AUX CH ▶ S. BUS
- ▶ SERVO ▶ M TRANS

MENU 3/4

MENU 1 2 3 4

- ▶ TIMER ▶ DR EXP
- ▶ TRAINR ▶ THR CRV
- ▶ THR CUT ▶ IDL DWN

MENU 4/4

MENU 1 2 3 4

- ▶ AIL DIF ▶ EL → FLP
- ▶ V-TAIL ▶ FLP → EL
- ▶ CAMBER
- ▶ AIR BRK

(Selection)

- Move the cursor (highlighted) up and down and to the left and right with the **Jog key** and select the function. The cursor can be moved over several pages.

(Calling the setting screen)

- Press the **Jog key** to open the setting screen.



■ The menu items can be changed according to the WING type. For example, if WING type is 1AIL, since the item blinks, reference only the item of the WING type used.
Relevant WING type display → **WING TYPE** **1AIL** **1AIL1FLP** **2AIL** **2AIL1FLP** **ELEVON**

Refer to "**Common Functions**" previously described for a description of this function.

■ **Function**

◆ **MENU 1/4**

MDL SEL	P.52
MDL TYP	P.55
MDL NAM	P.57
F/S	P.59
E POINT	P.61
TRIM	P.62
SUB TRM	P.63
REVERS	P.64

◆ **MENU 2/4**

PRMTR	P.65
P.MIX	P.70
AUX CH	P.73
SERVO	P.74
TLMTRY	P.75
SENSOR	P.91
S.BUS	P.93
M TRANS	P.96

◆ **MENU 3/4**

TIMER	P.97
TRAINER	P.100
THR CUT	P.104
DR EXP	P.106
THR CRV	P.108
IDL DWN	P.109
GYRO	P.110

Airplane

◆ **MENU 4/4**

AIL DIF	P.111
V TAIL	P.112
CAMBER	P.113
AIR BRK	P.114
EL → FLP	P.116
FLP → EL	P.117
ELEVON	P.118

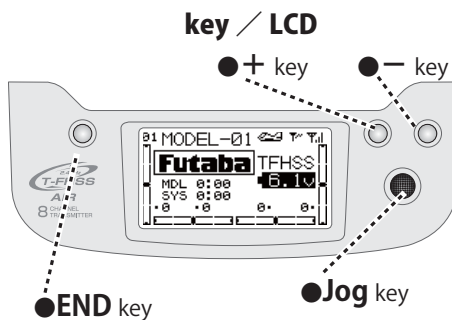



THR CUT Throttle cut (AIRPLANE)

WING TYPE **1TAIL 1AIL1FLP 2AIL 2AIL1FLP ELEVON**

Function

This function cuts (stops) the engine or motor by stick operation. At throttle operation, the rate is adjusted to the position which completely cuts the throttle servo or ESC when the throttle is operated. When THR CUT is active, the throttle position is held regardless of the throttle stick position.

is reset. When the throttle stick is higher than the set throttle position, the throttle cut function is not reset even if the switch is set to OFF. Set to a safe throttle position (slow side). (NOR/ESC mode the next page referring.)

- The throttle position when the function is reset can be set so the motor will not unexpectedly run at high speed when the throttle cut function

- Function operation can be selected from among switches A-D.
- Set the throttle cut function for safety also.

Method

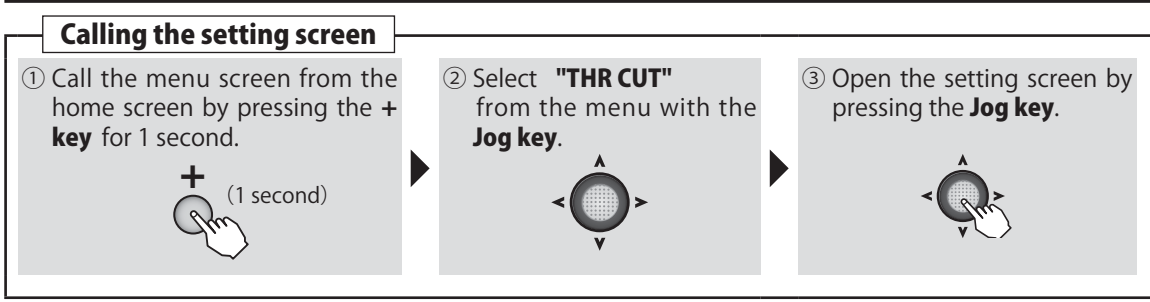

Airplane



THR CUT MIX ▶ INH

Mode ▶ NOR

Cut Position rate ▶ 0%

Throttle Position ▶ 15% (0%)

Switch selection ▶ SWA ▶ NULL

Activating the function

- When not using this Function select INH. The display of On/Off is shown when active and assigned to a switch.
- Adjusts the rate to the position that completely cuts the throttle servo or ESC.
- The value in parentheses is the current throttle stick position.

- Select the setting item with the **Jog key**.
- Sets the ON/OFF direction of the selected switch.
 - 2P SW : NULL, UP, DOWN
 - 3P SW : NULL, UP, UP&D, UP&C, CNTR, C&DN, DOWN

Throttle Cut

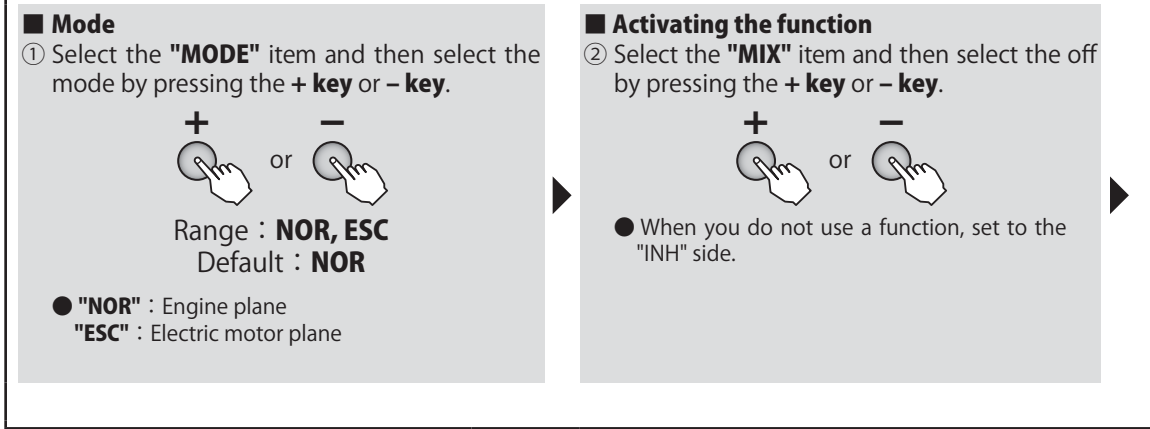



Throttle Cut

Switch selection

③ Select the "SW" item and then select the switch by pressing the **+ key** or **- key**.

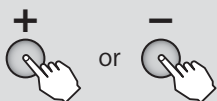

Range : **SwA-SwD**

Default : **SwA**

Switch direction

④ Select the "POSI" by pressing the **+ key** or **- key** at the ON direction selection item.

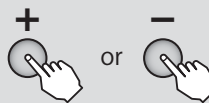

Range :

- 2P SW : **NULL, UP, DOWN**
- 3P SW : **NULL, UP, UP&D, UP&C, CNTR, C&DN, DOWN**

Cut Position rate

⑤ Select the "RATE" item and then select the cht position by pressing the **+ key** or **- key** (motor stop).

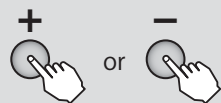

- It adjusts to the position where an engine is cut.

Range : **-30 to +30%**

Default : **0%**

- When you want to return the set value to the initial value, press the **+ key** and **- key** simultaneously.

Function Throttle Position

⑥ Select the "THR" item and then select the position by THR stick is lowered and **Jog key** is pressed for 1 second.



- Set to a safe low throttle position.

Range : **0-100%**

Default : **15%**

NOR MODE (Engine)

THR CHT



Cut switch ON



THR stick Low

(It's possible to do positional change.)

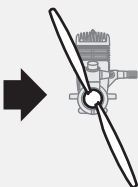

Engine stop

Release



Cut switch OFF



THR stick Low

(It's possible to do positional change.)



THR Active

ESC MODE (Motor)

THR CHT



Cut switch ON

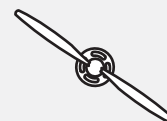

Motor Stop

Release



THR stick middle-high
(Besides the low)

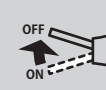

Cut switch OFF

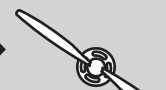

Motor Stop



THR stick Low



Cut switch OFF



Low→High



Start

(It's possible to do positional change.)



DR EXP

Dual rate / EXPO

(AIRPLANE)

WING TYPE 1AIL 1AIL1FLP 2AIL 2AIL1FLP ELEVON

Function

D/R

The aileron, elevator and rudder channel control surface angle can be switched in 2(3) steps

- The control surface angle is adjusted by each direction of the switch. The direction of each switch can be set individually.

EXP

This function makes operation more pleasant by changing the operating curve so that servo movement is sluggish or sensitive relative to stick operation near the aileron, elevator, throttle, and rudder neutral position. Adjustments can be made in 2(3) steps according to the control surface angle.

- The "-" side makes servo movement sluggish and the "+" side makes servo movement sensitive near the neutral position. Exponential is applied to entire throttle servo travel. When the "+" side is increased, the slow side becomes sluggish and the high side becomes sensitive.
- Setting corresponding to each rate of dual rate (D/R) is possible. (Except throttle) The direction of each switch and the left and right (up and down) direction of each channel can be set individually.

Switch selection (SW)

Switches A to D can be selected as the aileron channel, elevator channel, and rudder channel dual rate (exponential) switch.

- Default : Aileron : SwitchD / Elevator : SwitchA / Rudder : SwitchB

Method

Calling the setting screen

① Call the menu screen from the home screen by pressing the + key for 1 second.



② Select "DR EXP" from the menu with the Jog key.

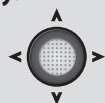

③ Open the setting screen by pressing the Jog key.

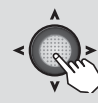

Airplane

● Channel selection/Select the setting item with the Jog key.

● The channel under selection is underlined.

(Switch Direction)

● The dual rate and exponential settings are displayed by a curve.

< Channel >
 1 : Aileron
 2 : Elevator
 3 : Throttle
 4 : Rudder

(D/R and EXPO rate display)
 Top row ; Left side / down
 Bottom row ; Right side / up

Select the (←) ↔ (→) L,R/U,D with the stick.

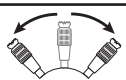



D/R

- ① A channel is chosen by **Jog key**.



Range : **1, 2, 4**

- ② Adjust the rate by moving the cursor to D/R with the **Jog key**, switching the dual rate switch to the direction you want to set, moving the stick to the left (down) or right (up) side and pressing the **+ key** or **- key**.



Range :
0-140%
Default : **100%**

- When you want to return the set value to the initial value, press the **+ key** and **- key** simultaneously.

Adjust the rate of each direction of the dual rate switch and stick by repeating step

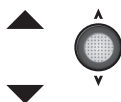

- Moving to another setting item of the same channel is possible by **Jog key**.

EXPO

- ① Select the "**EXP**" item and then select the channel with the **Jog key**.



Range : **1-4**

- ② Adjust the rate by moving the cursor to EXP with the **Jog key**, switching the dual rate switch to the direction you want to set, moving the stick to the left (down) or right (up) side and pressing the **+ key** or **- key**.



Range :
-100 to +100%
Default : **0%**

- When you want to return the set value to the initial value, press the **+ key** and **- key** simultaneously.

Adjust the rate of each direction of the dual rate switch and stick by repeating step

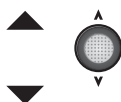

- Moving to another setting item of the same channel is possible by **Jog key**.

Switch Change

- ① Select the "**SW**" item and then select the channel with the **Jog key**.



Range : **1, 2, 4**

- ② A switch is chosen by **+ key** or **-key**.



Range : **SwA-SwD**



THR CRV Throttle curve (AIRPLANE)

WING TYPE **1AIL 1AIL1FLP 2AIL 2AIL1FLP ELEVON**

Function

This function sets a 5 point throttle curve so that the engine/motor speed relative to movement of the throttle stick is the optimum value for flight.

- A curve can be set for each switch position.

However, this function cannot be used when the throttle EXP function was set. When this function is set, the throttle EXP function cannot be used.

Method

Calling the setting screen



Airplane

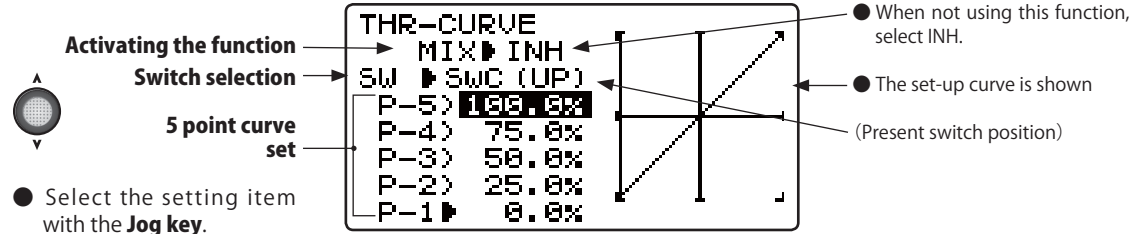

Throttle curve

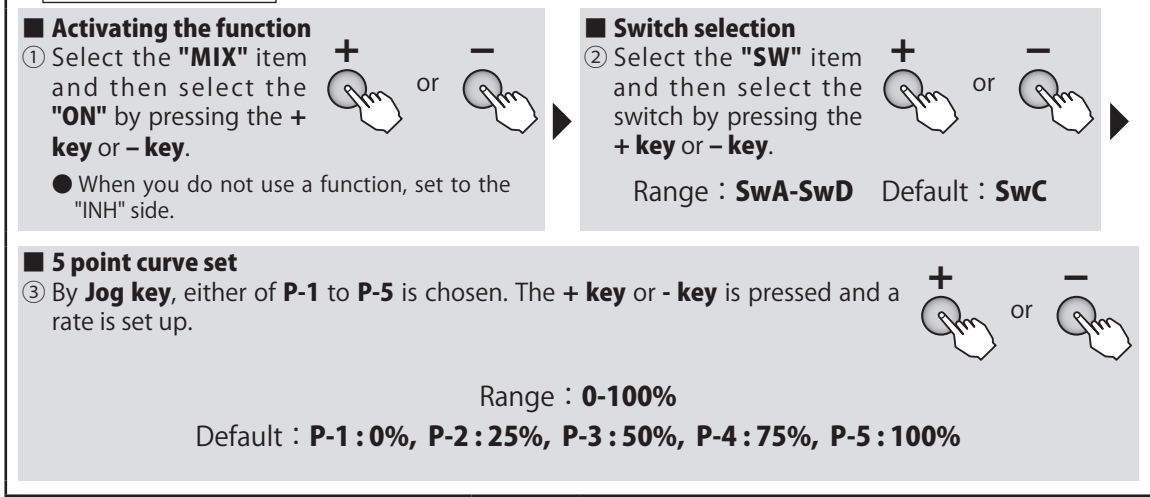



IDL DWN Idle down

(AIRPLANE)

WING TYPE 1AIL 1AIL1FLP 2AIL 2AIL1FLP ELEVON

Function

This function is linked to the air brake switch and gear switch and lowers the engine idle. It is used when engine idle is set high to prevent the engine from stalling during flight and you want to lower engine idle when landing.

- The amount engine idle is lowered can be set.
- At idling down operation, the stop lever adjusts the idle down amount.
- Function operation can be selected from among switches A-D. The switch direction can also be selected.

Method

Calling the setting screen

① Call the menu screen from the home screen by pressing the **+** key for 1 second.



② Select "IDL DWN" from the menu with the **Jog key**.

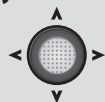

③ Open the setting screen by pressing the **Jog key**.

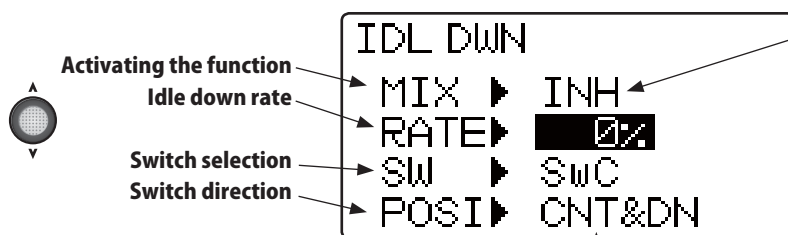
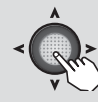

● When not using this Function select INH. The display of On/Off is shown when active and assigned to a switch.

● Select the setting item with the **Jog key**.

● Sets the ON/OFF direction of the selected switch.

○ 2P SW : NULL, UP, DOWN

○ 3P SW : NULL, UP, UP&DWN, UP&CNT, CENTER, CNT&DN, DOWN

Idle down

Activating the function

① Select the "MIX" item and then select the on or off by pressing the **+** key or **-** key.

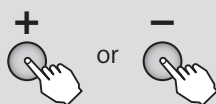

● When you do not use a function, set to the "INH" side.

Switch selection

② Select the "SW" item and then select the switch by pressing the **+** key or **-** key.

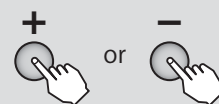

Range : SwA-SwD Default : SwC

Switch direction

③ Select the "POSI" by pressing the **+** key or **-** key at the ON direction selection item.

Range :

● 2P SW : NULL, UP, DOWN

● 3P SW : NULL, UP, UP&DWN, UP&CNT, CENTER, CNT&DN, DOWN

Idle down rate

④ Select the "RATE" item and then adjust the idle down rate by pressing the **+** key or **-** key.

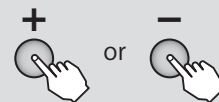

Range : 0-40%

Default : 0%

● When you want to return the set value to the initial value, press the **+** key and **-** key simultaneously.

● The idle down amount is usually 10%-20%. Hold down the aircraft and set the throttle switch to the maximum slow position while the engine is running and adjust the idle drop amount while turning the switch on and off.



GYRO

Gyro sensor

(AIRPLANE)

WING TYPE

1TAIL

2AIL

Function

This function is dedicated mixing for switching the gyro sensitivity and gyro mode (AVCS/NORMAL) of Futaba airplane use gyros.

- The sensitivity switch can be selected and the sensitivity of each direction of the switch can be set. (Switches A to D) If the airplane stalls during flight, the gyro will lose control of the plane's

attitude. From the standpoint of safety, we recommend that the OFF (0%) position also be set using a 3 position switch.

- T6K only 1 channel gain control.
- 3 axes gyro of gain can't be controlled independently.

Method

Calling the setting screen

① Call the menu screen from the home screen by pressing the + key for 1 second.



② Select "GYRO" from the menu with the Jog key.

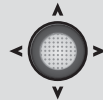

③ Open the setting screen by pressing the Jog key.



Activating the function

Switch position

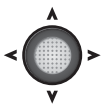

- Select the setting item with the Jog key.

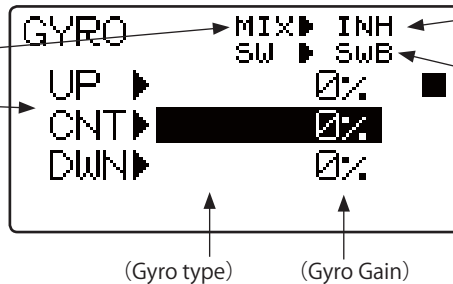

- When not using this function, select INH.

Gain switch selection

(Current switch operating direction)

- Switches to the sensitivity setting screen of each switch direction when the Jog key is pressed.



GYRO setup

■ Activating the function

① Select the "MIX" item and then select the "ON" by pressing the + key or - key.

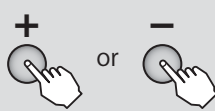

- When you do not use a function, set to the "INH" side.

■ Gain switch selection

② Select the "SW" item and then select the switch by pressing the + key or - key.

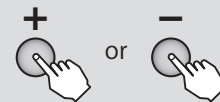

Range : SwA-SwD Default : SwB

■ Gyro mode and gain setting

③ UP, CNT, DWN, shows the switch position. Set the respective positional gain and mode.

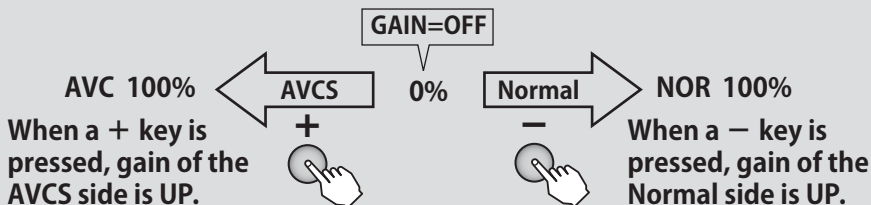



AIL DIF Aileron differential

(AIRPLANE)

WING TYPE

2AIL 2AIL1FLP

Function

The left and right aileron differential can be adjusted independently. This function is restricted to 2 servo aileron.

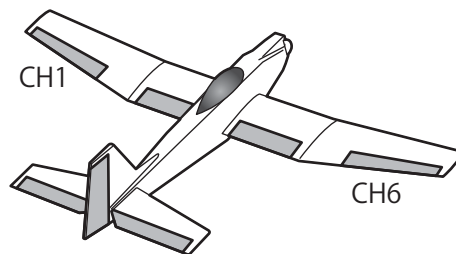

Method

Calling the setting screen

① Call the menu screen from the home screen by pressing the **+** key for 1 second.



② Select **"AIL DIF"** from the menu with the **Jog key**.

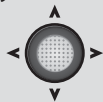

③ Open the setting screen by pressing the **Jog key**.



AIL DIF

	(L)	(R)
Aileron1 (CH1) rate → AIL1	+100	+100
Aileron6 (CH6) rate → AIL6	+100	+100

(Aileron)
L : Aileron stick Left side rate
R : Aileron stick Right side rate

● Select the setting item with the **Jog key**.

Select the Left/Right with the **aileron stick**.

Aileron Differential

■ Activating the function

① Select the **"2AIL"** or **"2AIL1FLP"** by WING type (MDL TYP).

■ Aileron rate

② Select the **"AIL1"** item and move the aileron stick to the left and right and adjust the travel of each servo by pressing the **+** key or **-** key.

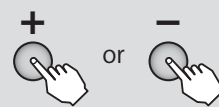

Range : **-120 to +120%**
Default : **+100%**

● When you want to return to the initial value, press the **+** key and **-** key simultaneously. However, when the polarity is changed only the number returns to the initial value.

(Adjust the **"AIL6"** item in the same way as ②.)

Airplane



V-TAIL (AIRPLANE)

WING TYPE 1AIL 1AIL1FLP 2AIL 2AIL1FLP

Function

This mixing is used with V tail aircraft that combine the elevator and rudder functions.

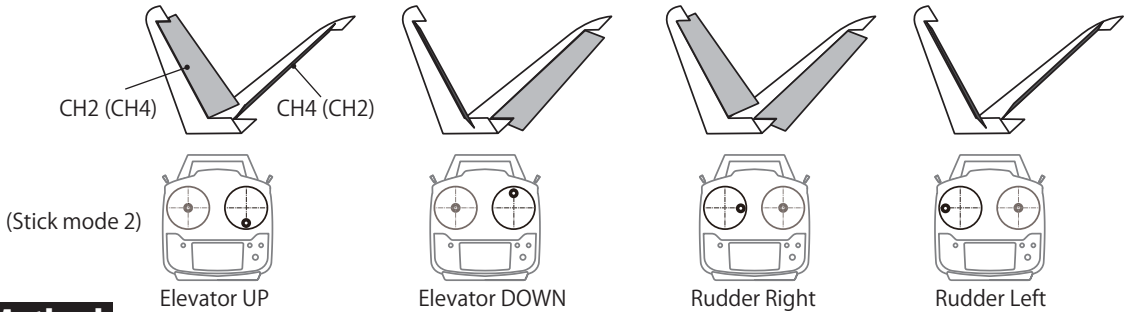

Method

Calling the setting screen

- Call the menu screen from the home screen by pressing the **+** key for 1 second.
- Select **"V-TAIL"** from the menu with the **Jog** key.
- Open the setting screen by pressing the **Jog** key.

Airplane

Activating the function

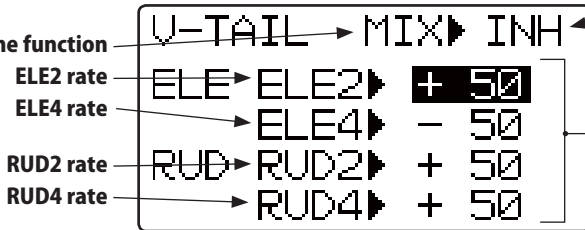

● When INH is selected, the function cannot be used. To use the function, select ACT.

● Select the setting item with the **Jog** key.

V-TAIL

Activating the function

- Select the **"MIX"** item and then select the **"ACT"** by pressing the **+** key or **-** key.

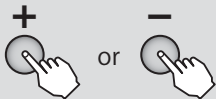

● When you do not use a function, set to the "INH" side.

Rate adjustment

- Select the value item and then adjust the mixing rate by pressing the **+** key or **-** key.

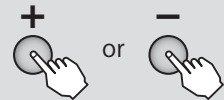

Range : **-100 to +100%**
 Default : **+50%**
 (only **ELE4** : **-50%**)

● When you want to return the set value to the initial value, press the **+** key and **-** key simultaneously. However, polarity does not return.

NOTE : We recommend that setting be performed while moving the stick and checking the amount of movement. If the amount of movement is too large, elevator and rudder operation will be compounded and the servo travel range will be exceeded and a dead band in which the servo will not operate may be created.



(GLIDER)

CAMBER Camber

WING TYPE

1AIL1FLP

2AIL

2AIL1FLP

ELEVON

Function

The up/down travel of each flap/aileron (flaps: FLP5, ailerons: AIL1/6) can be adjusted independently for each servo according to the wing type. The camber operates by switch A.

- The axis of each flap can be shifted
- The control switch can be changed

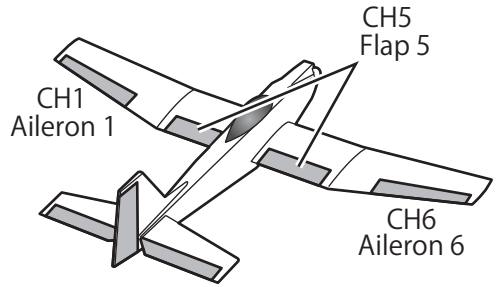

Method

Calling the setting screen

① Call the menu screen from the home screen by pressing the **+** key for 1 second.



② Select **"CAMBER"** from the menu with the **Jog key**.

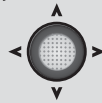

③ Open the setting screen by pressing the **Jog key**.

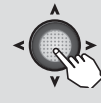

CAMBER		(UP)	(CNT)	(DWN)
● Switch position	→			
● Aileron 1	→ AIL1	0	0	0
● Aileron 6	→ AIL6	0	0	0
● Elevator	→ ELE	0	0	0
● Flap	→ FLP	0	0	0
● Activating the function	→ MIX	INH		
● Switch selection	→ SW	SWA	(DWN)	

● Current switch position

- Select the setting item with the **Jog key**.
- The value is changed by **+** key or **-** key.

Airplane



AIR BRK Air brake (AIRPLANE)

Function **WING TYPE** 1AIL1FLP 2AIL 2AIL1FLP ELEVON

This function is used when the air brake is necessary during landing and is turned on and off by switch D (initial setting).

- Normally when the ailerons are used as a brake, they are raised (UP side)
- When the operation mode is "OFST" (offset), the air brake is controlled by switch operation. When the operation mode is "LINR" (linear), the air brake is operated linearly at switch ON and from the control stick set position.

- If the "LINR" mode was selected, the throttle stick controls CH3 and the air brake operation, but it can be separated from CH3 operation. CH 3 control can be switched from stick to stick or to VR knob. However, when other than stick was selected, the throttle trim and function reverse functions cannot be used.
- When used in the "LINR" mode, adjust the travel with the throttle stick at the maximum slow side (braking amount maximum).

(Example)

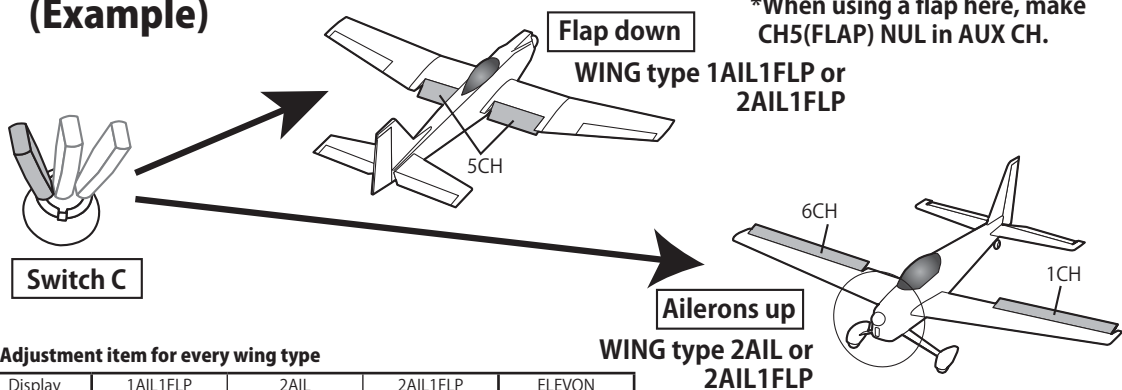

● Adjustment item for every wing type

Display	1AIL1FLP	2AIL	2AIL1FLP	ELEVON
AIL1(1CH)	----	Aileron1	Aileron1	----
ELEV(2CH)	Elevator	Elevator	Elevator	Elevator
FLAP(5CH)	Flap	----	Flap	Flap
AIL6(6CH)	----	Aileron6	Aileron6	----

Method

Calling the setting screen



Activating the function

Rate set

Elevator delay rate set

```

AIR-BRK
-rate= CH3
AIL1 MIX INH
ELEV - 10% SW SWC
FLAP + 50% DOWN
AIL2 MOD OFST
-delay
ELEV 0%
                    
```

3CH Control set (LINR mode)

- When not using this Function select INH. The display of On/ Off is shown when active and assigned to a switch.
- Switch selection**
- Switch direction**
- Mode**

- Select the setting item with the **Jog key**.
- When the "LINR" operation mode was selected, the current throttle stick position is displayed at the operation reference point and in the bottom row parentheses.



Air brake

■ Activating the function

- ① Select the "MIX" item and then select the "ON" or "OFF" by pressing the **+ key** or **- key**.

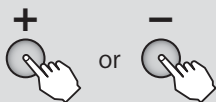

- When you do not use a function, set to the "INH" side.

■ Rate set

- ② Select the "rate" item and adjust the servo travel by pressing the **+ key** or **- key**.



Range : **-100 to +100%**
Default : **+50% (ELEV only -10%)**

- When you want to return the set value to the initial value, press the **+ key** and **- key** simultaneously. However, polarity does not return.

■ Delay Rate set

- ③ Select the "delay" item and adjust the elevator operation delay by pressing the **+ key** or **- key**.



- The amount of delay is large at 100%.

Range : **0-100%** Default : **0%**

- When you want to return the set value to the initial value, press the **+ key** and **- key** simultaneously.

(In the case of change of a switch)

■ Switch selection

- ① Select the "SW" item and then select the switch by pressing the **+ key** or **- key**.

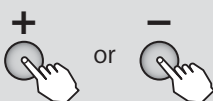

Range : **SwA-SwD**
Default : **SwD**

■ Switch direction

- ② Select the ON direction by pressing the **+ key** or **- key** at the ON direction selection item.

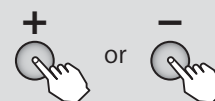

Range :

- 2P SW : **NULL, UP, DOWN**
- 3P SW : **NULL, UP, UP&DN, UP&CT, CENTR, CT&DN, DOWN**

(In the case of change of a mode)

■ Mode

- ① Select the "MOD" item and select the operation mode by pressing the **+ key** or the **- key**.

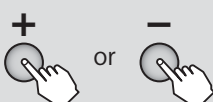

Range : **OFST, LINR**
Default : **OFST**

■ Operation reference point setting ("LINR" mode only)

- ② Select the operation reference point setting item newly displayed at the bottom row of "MOD" and hold the throttle stick at the air brake start point and set the reference point by pressing the **Jog key** for 1 second.

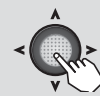

Range : **0-100%**

(When 3CH control is changed at the time of "LINR")

■ "LINR" mode 3CH control

- ① Select the "CH3" item and select control by pressing the **+ key** or **- key**.

Range : **THR, SwA-SwD, VR**
Default : **THR**



EL → FLP Elevator → Flap mixing (AIRPLANE)

WING TYPE 1AIL1FLP 2AIL1FLP ELEVON

Function

This mixing is used when you want to apply mixing from elevator to flap. Usually, mixing is such that the flap are lowered by raising the elevator. When used with Fun Fly and other aircraft, small loops are possible.

- The up side and down side rates can be adjusted.

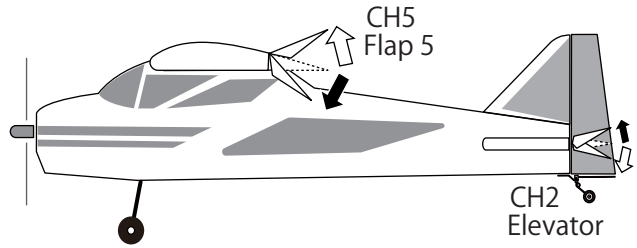

Method

Calling the setting screen

- ① Call the menu screen from the home screen by pressing the **+** key for 1 second.



- ② Select "EL → FLP" from the menu with the **Jog key**.

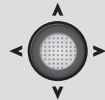

- ③ Open the setting screen by pressing the **Jog key**.

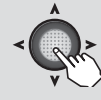

Select the ↑ / ↓ with the elevator stick.

Mixing rate → RATE ▶ + 50 (+) + 50 (+)

Activating the function → MIX ▶ INH

Switch selection → SW ▶ SwD

Switch direction → POSI ▶ UP

(Elevator up side rate)

(Elevator down side rate)

● When not using this Function select INH. The display of On/Off is shown when active and assigned to a switch.

● Sets the ON/OFF direction of the selected switch.

○ 2P SW : NULL, UP, DOWN

○ 3P SW : NULL, UP, UP&DWN, UP&CNT, CENTER, CNT&DN, DOWN

Airplane

Elevator → Flap Mixing

■ Activating the function

- ① Select the "MIX" item and then select the **ON** or **OFF** by pressing the **+** key or **-** key.
 - When you do not use a function, set to the "INH" side.

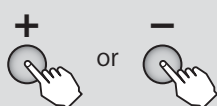

■ Switch selection

- ② Select the "SW" item and then select the switch by pressing the **+** key or **-** key.

Range : SwA-SwD

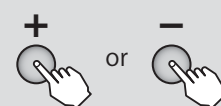

■ Switch direction

- ③ Select the "POSI" by pressing the **+** key or **-** key at the **ON** direction selection item.

Range :

 - 2P SW : NULL, UP, DOWN
 - 3P SW : NULL, UP, UP&DWN, UP&CNT, CENTER, CNT&DN, DOWN

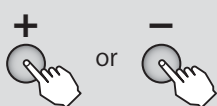

■ Mixing rate

- ④ Select the "RATE" item and then adjust the mixing rate by pressing the **+** key or **-** key.

Range : -100 to +100% Default : +50%

 - When you want to return the set value to the initial value, press the **+** key and **-** key simultaneously. However, polarity does not return.
 - RATE ↑ / ↓ cursor position operates and chooses an elevator stick.

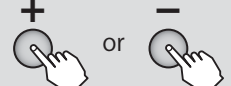



FLP → EL Flap → Elevator mixing (AIRPLANE)

WING TYPE 1AIL1FLP 2AIL1FLP ELEVON

Function

This mixing is used to compensate for pitch changes (elevator direction) at flap operation.

- When the mixing direction is reversed by the linkage adjustment is possible by changing the rate polarity.
- The mixing reference point can be shifted. (OFFSET)

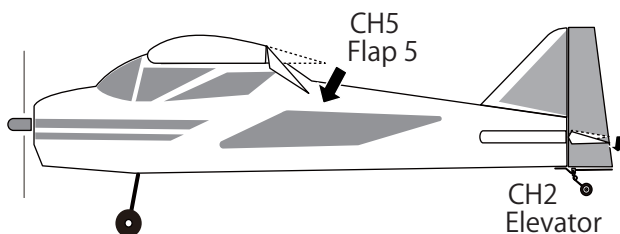

Method

Calling the setting screen

① Call the menu screen from the home screen by pressing the **+** key for 1 second.



② Select "FLP → EL" from the menu with the **Jog key**.

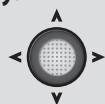

③ Open the setting screen by pressing the **Jog key**.

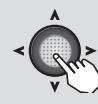

Activating the function

Mixing rate

Mixing offset rate

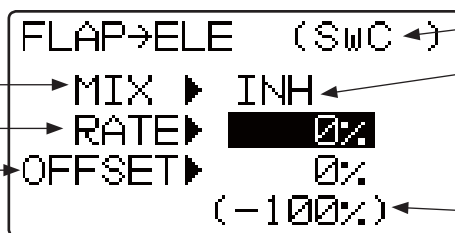

- The movement switch is common with flap CH.
- When not using this function, select INH.

(Present flap operating position)

- Select the setting item with the **Jog key**.

Flap → Elevator Mixing

■ Activating the function

① Select the "MIX" item and then select the "ON" by pressing the **+** key or **-** key.

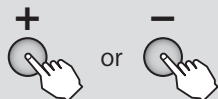

- When you do not use a function, set to the "INH" side.

■ Mixing rate

② Select the "RATE" item and then adjust the mixing rate by pressing the **+** key or **-** key.

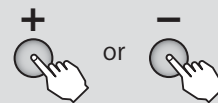

Range : -100 to +100%
Default : 0%

- When you want to return the set value to the initial value, press the **+** key and **-** key simultaneously.

(When changing the mixing reference point)

■ Mixing reference point offset setting

① Select the "OFFSET" item and turn the Flap CH to the point you want to make the mixing reference point and set the reference point by pressing the **Jog key** for 1 second.



Range : -100 to +100% Default : 0%



ELEVON Elevon (AIRPLANE)

Function WING TYPE ELEVON

This mixing is used with delta wing, tail-less, and disk shaped airplanes that combine the aileron and elevator functions.

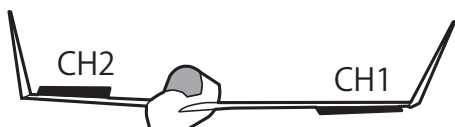
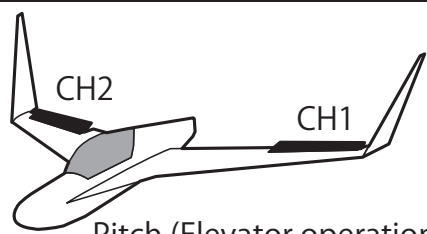

Connect the CH1 servo to the left aileron and the CH2 servo to the right aileron.

- The aileron and elevator travel can be adjusted individually.



Method

Calling the setting screen

- ① Call the menu screen from the home screen by pressing the **+** key for 1 second. 
- ② Select "ELEVON" from the menu with the **Jog** key. 
- ③ Open the setting screen by pressing the **Jog** key. 

Airplane



	(L)	(R)
Aileron1 (CH1) rate	AIL1 ▶ +100	+100
Aileron2 (CH2) rate	AIL2 ▶ +100	+100
Elevator2 (CH1) rate	ELE1 ▶ +100	
Elevator1 (CH2) rate	ELE2 ▶ -100	

Select the Left/Right with the aileron stick. 

(Aileron rate)
L : Aileron stick Left side rate
R : Aileron stick Right side rate
(Elevator rate)

- Select the setting item with the **Jog** key.

ELEVON

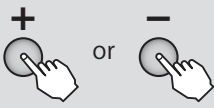
- **Activating the function**
 - ① Select the "ELEVON" by WING type (MDL TYP).
- **Rate set**
 - ② Select the "RATE" item and then adjust the mixing rate by pressing the **+** key or **-** key. 

Range : -120 to +120%
Default : +100%
(only ELE1 : -100%)

 - When you want to return the set value to the initial value, press the **+** key and **-** key simultaneously. However, polarity does not return.

NOTE : We recommend that setting be performed while moving the stick and checking the amount of movement. If the amount of movement is too large, elevator and aileron operation will be compounded and the servo travel range will be exceeded and a dead band in which the servo will not operate may be created.

HELICOPTER Function



The setting screen of each function is called from the following menu. The function when the model type was set to helicopter is displayed here.

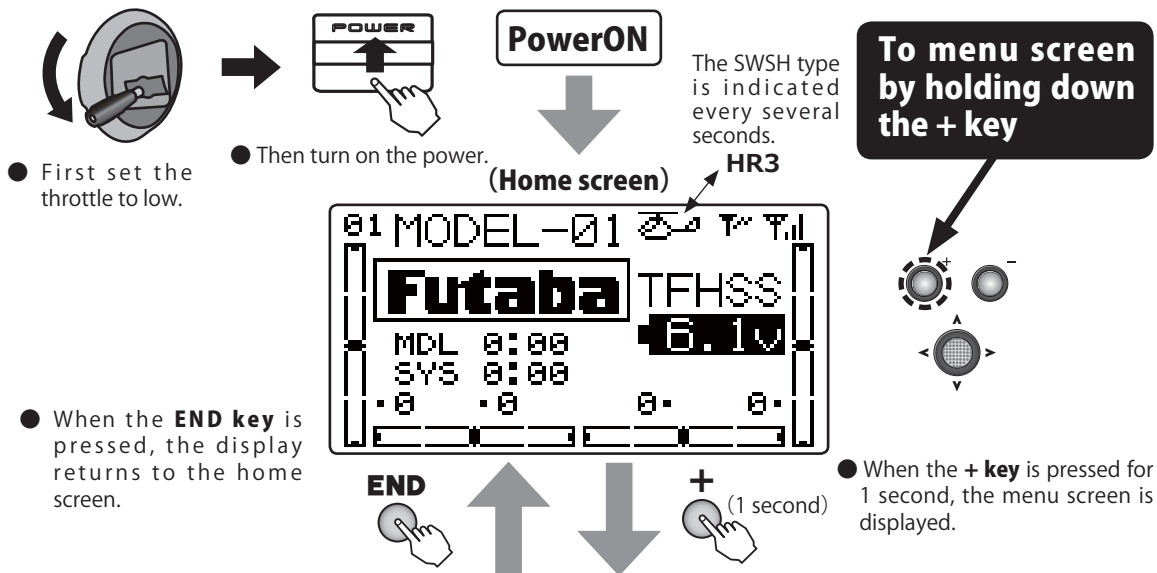

MENU

MENU 1/4

MENU 2/4

MENU 3/4

MENU 4/4

MENU 1 2 3 4
▶ MDL SEL ▶ E POINT
▶ MDL TYP ▶ TRIM
▶ MDL NAM ▶ SUB TRM
▶ F/S ▶ REVERS

MENU 1 2 3 4
▶ PRMTR ▶ TLMTRY
▶ P. MIX ▶ SENSOR
▶ AUX CH ▶ S. BUS
▶ SERVO ▶ M TRANS

MENU 1 2 3 4
▶ TIMER ▶ DR EXP
▶ TRAINR ▶ OFFSET
▶ CONDIT ▶ DELAY
▶ THR CUT ▶ GYRO

MENU 1 2 3 4
▶ SWH AFR ▶ REVO MX
▶ SWH MIX ▶ TH HOLD
▶ THR CRV ▶ HOV THR
▶ PIT CRV ▶ HOV PIT

(Selection)

● Move the cursor (highlighted) up and down and to the left and right with the Jog key and select the function. The cursor can be moved over several pages.

(Calling the setting screen)

● Press the Jog key to open the setting screen.

Helicopter

119



Refer to "**Common Functions**" previously described for a description of this function.

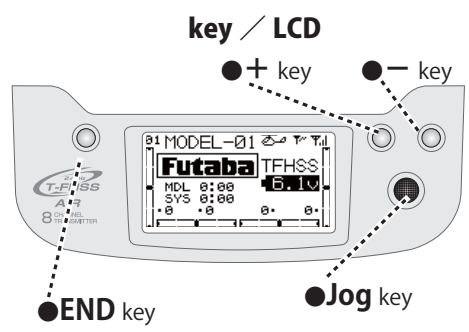

■ **Function**

◆ **MENU 1/4**

MDL SEL	P.52
MDL TYP	P.55
MDL NAM	P.57
F/S	P.59
E POINT	P.61
TRIM	P.62
SUB TRM	P.63
REVERS	P.64

◆ **MENU 2/4**

PRMTR	P.65
P.MIX	P.70
AUX CH	P.73
SERVO	P.74
TLMTRY	P.75
SENSOR	P.91
S.BUS	P.93
M TRANS	P.96

◆ **MENU 3/4**

TIMER	P.97
TRAINER	P.100
CONDIT	P.121
THR CUT	P.122
DR EXP	P.124
OFFSET	P.126
DELAY	P.127
GYRO	P.128

◆ **MENU 4/4**

SWH AFR	P.129
SWH MIX	P.130
THR CRV	P.132
PIT CRV	P.134
REVO MX	P.136
TH HOLD	P.138
HOV THR	P.139
HOV PIT	P.140

Helicopter

(Condition switching at each setting screen)

- Press the jog button for 1 second. When setting conditions with the following function, each setting can be made by switching the condition by pressing the **Jog key** for 1 second. D/R, EXPO, Throttle curve, Pitch curve, OFFSET, Swash MIX



CONDIT Condition select (Idle-up • Throttlehold) (HELICOPTER)

Function

The condition switches (idle up 1/2 and throttle hold switch) are not operative at initial setting. Switch setting is performed in advance with the condition select function.

• Initially set to idle up 1: SwC (center), idle up 2: SwC (down), throttle hold: SwD (down).

Method

Calling the setting screen

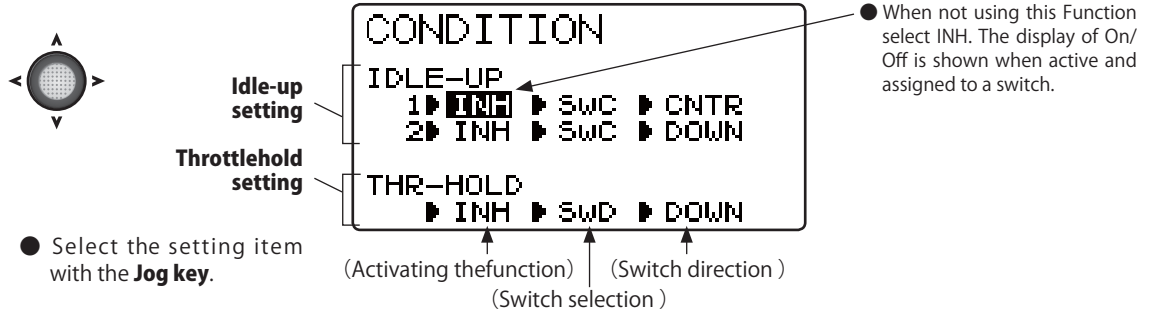
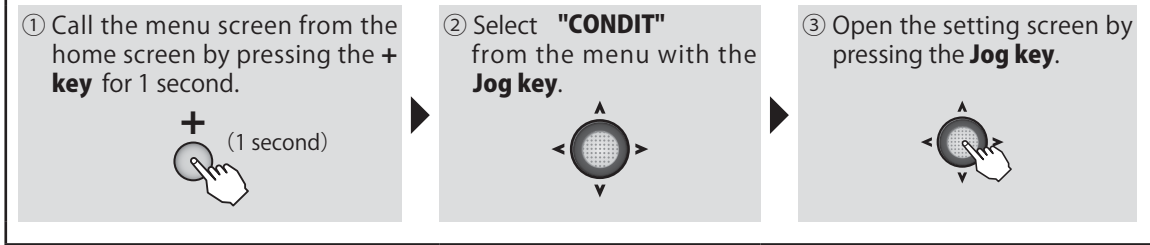

● Select the setting item with the **Jog key**.

Condition select

■ **Activating the function**

① Select the "INH" item of the condition you want to use and set it to "ON" or "OFF" by pressing the **+ key** or **- key**.

● Set conditions you do not want to use to "INH".

(In the case of change of a switch)

■ **Switch selection**

② A cursor is moved to "Switch selection" and a switch is changed by **+ key** or **- key**.

Range : **SwA-SwD**
Default : **SwC** (IDLE-UP1), **SwC** (IDLE-UP2), **SwD** (THR-HOLD)

■ **Switch direction**

③ A cursor is moved to "Switch direction" and a switch direction is changed by **+ key** or **- key**.

Range :
● 2P SW : **NULL, UP, DOWN**
● 3P SW : **NULL, UP, UP&D, UP&C, CNTR, C&DN, DOWN**

Helicopter



THR CUT Throttle cut (HELICOPTER)

Function

This function cuts (stops) the engine or motor by stick operation. At throttle operation, the rate is adjusted to the position which completely cuts the throttle servo or ESC when the throttle is operated. When THR CUT is active, the throttle position is held regardless of the throttle stick position.

is reset. When the throttle stick is higher than the set throttle position, the throttle cut function is not reset even if the switch is set to OFF. Set to a safe throttle position (slow side). (NOR/ESC mode the next page referring.)

- The throttle position when the function is reset can be set so the motor will not unexpectedly run at high speed when the throttle cut function

- Function operation can be selected from among switches A-D.
- Set the throttle cut function for safety also.

Method

Calling the setting screen

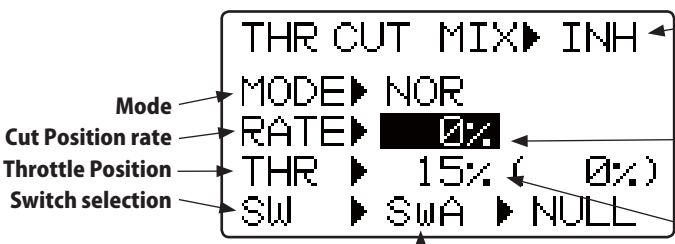
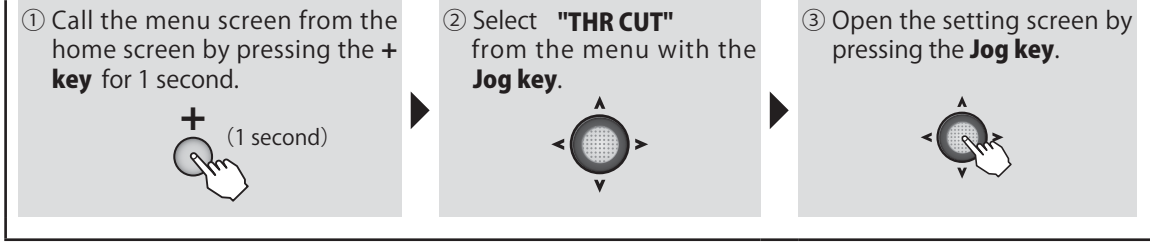

Activating the function

- When not using this Function select INH. The display of On/Off is shown when active and assigned to a switch.
- Adjusts the rate to the position that completely cuts the throttle servo or ESC.
- The value in parentheses is the current throttle stick position.

- Select the setting item with the Jog key.
- Sets the ON/OFF direction of the selected switch.
 - 2P SW : NULL, UP, DOWN
 - 3P SW : NULL, UP, UP&D, UP&C, CNTR, C&DN, DOWN

Throttle Cut

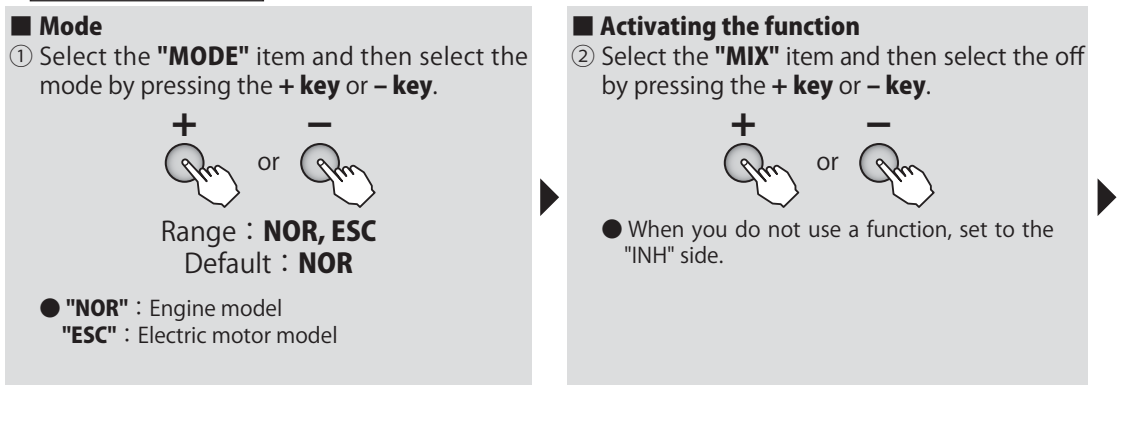

Mode

① Select the "MODE" item and then select the mode by pressing the + key or - key.

+ or -

Range : NOR, ESC
Default : NOR

- "NOR" : Engine model
- "ESC" : Electric motor model

Activating the function

② Select the "MIX" item and then select the off by pressing the + key or - key.

+ or -

- When you do not use a function, set to the "INH" side.

Helicopter



Throttle Cut

Switch selection

③ Select the "SW" item and then select the switch by pressing the **+ key** or **- key**.

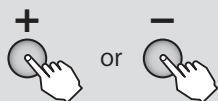

Range : **SwA-SwD**

Default : **SwA**

Switch direction

④ Select the "POSI" by pressing the **+ key** or **- key** at the ON direction selection item.

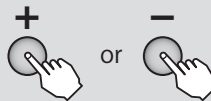

Range :

- 2P SW : **NULL, UP, DOWN**
- 3P SW : **NULL, UP, UP&D, UP&C, CNTR, C&DN, DOWN**

Cut Position rate

⑤ Select the "RATE" item and then select the cht position by pressing the **+ key** or **- key** (motor stop).

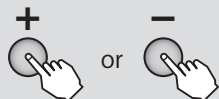

- It adjusts to the position where an engine is cut.

Range : **-30 to +30%**

Default : **0%**

- When you want to return the set value to the initial value, press the **+ key** and **- key** simultaneously.

Function Throttle Position

⑥ Select the "THR" item and then select the position by THR stick is lowered and **Jog key** is pressed for 1 second.



- Set to a safe low throttle position.

Range : **0-100%**

Default : **15%**

NOR MODE (Engine)

THR CHT



Cut switch ON

THR stick Low

(It's possible to do positional change.)

Engine stop

Release



Cut switch OFF

THR stick Low

(It's possible to do positional change.)

THR Active

ESC MODE (Motor)

THR CHT

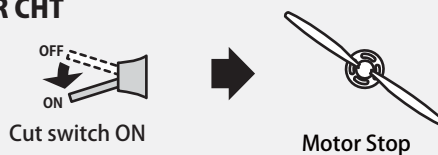

Cut switch ON

Motor Stop

Release

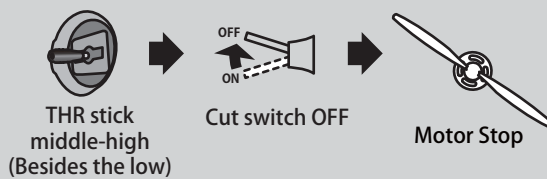

THR stick middle-high
(Besides the low)

Cut switch OFF

Motor Stop

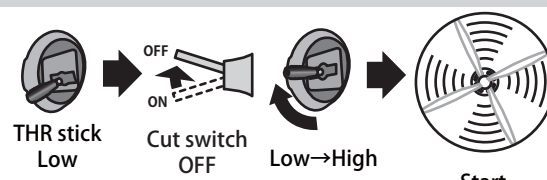

THR stick Low
(It's possible to do positional change.)

Cut switch OFF

Low to High

Start



DR EXP Dual rate / EXPO (HELICOPTER)

Function

D/R

The aileron, elevator and rudder channel control surface angle can be switched in 2 (3) steps

- The control surface angle is adjusted by each direction of the switch or condition. The left and right (up and down) direction of each switch can be set individually.

EXP

This function makes operation more pleasant by changing the operating curve so that servo movement is sluggish or sensitive relative to stick operation near the aileron, elevator, and rudder neutral position. Adjustments can be made in 2 (3) steps according to the control surface angle.

- The "-" side makes servo movement sluggish and the "+" side makes servo movement sensitive near the neutral position.
- Setting corresponding to each rate of dual rate (D/R) is possible. (Except throttle) The direction of each switch and the left and right (up and down) direction of each channel can be set individually.

Switch selection (SW)

Switches A to D can be selected as the aileron channel, elevator channel, and rudder channel dual rate (exponential) switch.

- Select : Switch A-Switch D / condition : Cond
- Default : Aileron : Switch D / Elevator : Switch A / Rudder : Switch B

Method

Calling the setting screen

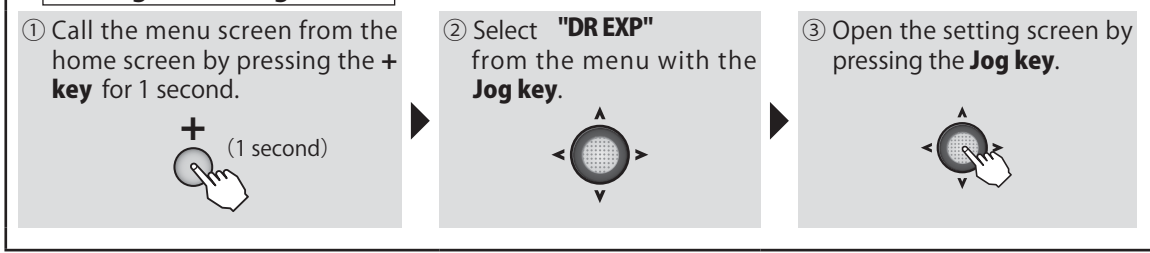

Helicopter

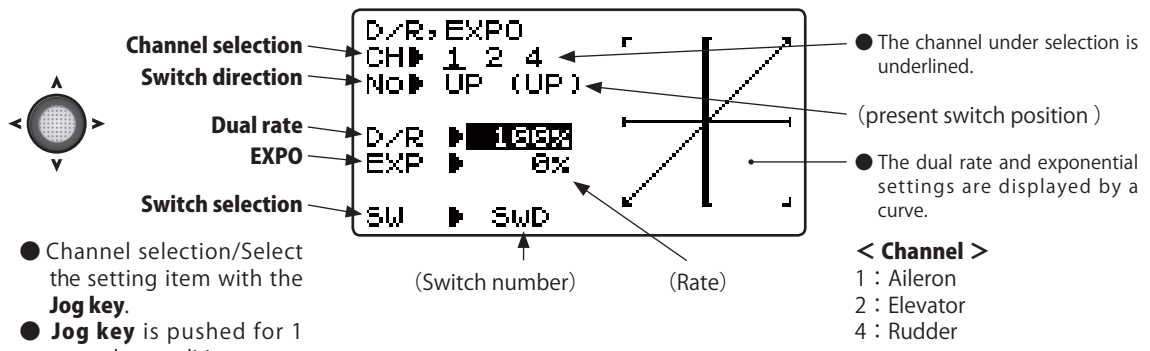

- Channel selection/Select the setting item with the **Jog key**.
- **Jog key** is pushed for 1 second, a condition screen will change.



Dual rate

■ Channel selection

- ① A channel is chosen by **Jog key**.



Range : 1, 2, 4

■ Switch direction

- ② Select the "No" item and then select the switch direction or condition by pressing the **+ key** or **- key**.

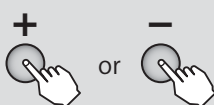

■ D/R Setup of rate

- ③ Select each function item of "D/R" and set the rate by pressing the **+ key** or **- key**.



Range : 0-140% Default : 100%

- When you want to return the set value to the initial value, press the **+ key** and **- key** simultaneously.

Adjust the rate of each direction of the dual rate switch and stick by repeating step

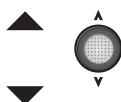

- Moving to another setting item of the same channel is possible by **Jog key**.

EXPO

■ Channel selection

- ① A channel is chosen by **Jog key**.



Range : 1, 2, 4

■ Switch direction

- ② Select the "No" item and then select the switch direction or condition by pressing the **+ key** or **- key**.



■ EXP Setup of rate

- ③ Select the "EXP" item and then adjust the rate by pressing the **+ key** or **- key**.



Range : -100 to +100%、Default : 0%

- When you want to return the set value to the initial value, press the **+ key** and **- key** simultaneously.

Adjust the rate of each direction of the dual rate switch and stick by repeating step

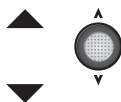

- Moving to another setting item of the same channel is possible by **Jog key**.

Switch Change

■ Channel selection

- ① Select the "SW" item and then select the channel with the **Jog key**.



Range : 1, 2, 4

■ Switch selection

- ② A switch or Cond is chosen by **+ key** or **- key**.



Range : SwA-SwD, Cond

- When "Cond" is chosen, a setup is possible for every condition.



OFFSET Trim offset (HELICOPTER)

Function

If this trim offset function is used, independent trim adjustments can be made during hovering and in the air. This function can offset the ailerons, elevators, and rudder neutral position by linking to the set switch or condition. A habit that tends to appear from the standpoint of helicopter characteristics when flying at high speed is possible. This function can correct this habit.

different depending on adjustment of the aircraft, decide the setting direction after flight. When the gyro is used in the AVCS mode at the rudder, etc., the offset rate is made 0% (initial setting) to make corrections at the gyro side.

- For a clockwise rotation rotor, since the helicopter tilts to the right during flight, use the offset function to set the swash plate so that the helicopter tilts to the left. Since the direction of the elevators is

- When the switch was selected 1 offset system can be set for a 2 position switch and 2 offset systems can be set for a 3 position switch. Linking to conditions (IDL1,2, HOLD) is also possible.
- When the offset function is on, data adjustment is possible even by digital trim. The trim adjusted rate is input in the air. (When the offset function is ON, the initial screen trim display is linked.)

Method

Calling the setting screen

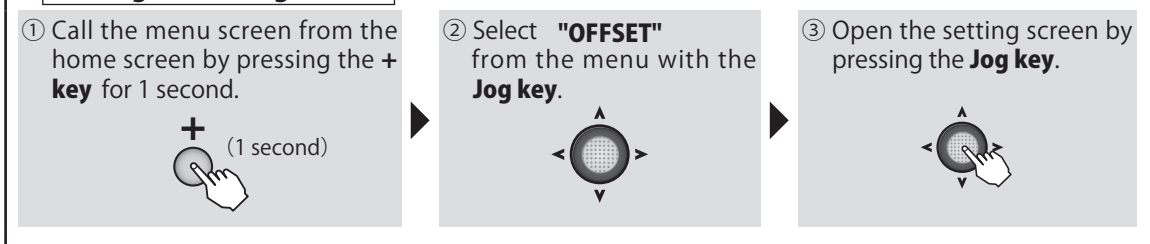

● Select the setting item with the **Jog key**.

Activating the function

Switch direction, Selection of condition

Offset rate

Switch selection

OFFSET	MIX	INH
COND	SW	Cond
AIL	IDL1 (NORM)	0%
ELE		0%
RUD		0%

● When not using this Function select INH. The display of On/Off is shown when active and assigned to a switch.

(Present condition)

● When "Cond" is chosen, if Jog key is pushed for 1 second, it will change to each condition setting screen.

Trim offset

■ **Activating the function**

① Select the "MIX" item and then select the "ON" or "OFF" by pressing the + key or - key.

● When you do not use a function, set to the "INH" side.

■ **Switch selection**

② Select the "SW" item and then select the switch by pressing the + key or - key.

Range : **Cond, SwA-SwD**

■ **Switch direction and condition selection**

③ Select the switch direction and condition you want to set at the switch direction and condition items.

■ **Offset rate**

④ Select the "RATE" item and then adjust the offset rate by pressing the + key or - key.

Range : **-120 to +120%**
Default : **0%**

● When you want to return the set value to the initial value, press the + key and - key simultaneously.

Helicopter



DELAY Delay (HELICOPTER)

Function

This function prevents sudden offset changes when the offset, condition functions are turned on and off.

- Delay can be set at the aileron, elevator, rudder, throttle, and pitch.
- The set delay is common to the offset, and condition functions.

Method

Calling the setting screen

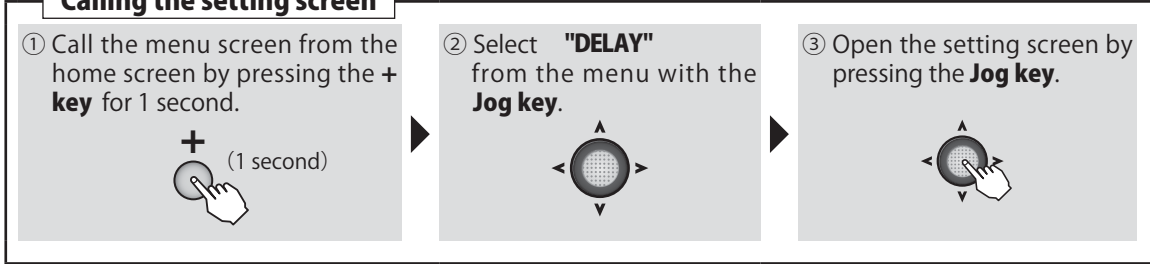

- Select the setting item with the **Jog key**.

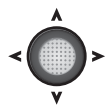

Delay rate

DELAY			
(OFFSET)		(COND)	
AIL▶	<input checked="" type="checkbox"/>	THR▶	<input checked="" type="checkbox"/>
ELE▶	<input type="checkbox"/>	PIT▶	<input type="checkbox"/>
RUD▶	<input type="checkbox"/>		

- The delay is maximum at 100% (slowly).

Delay rate

■ Delay rate setup

- ① Select the **"RATE"** item and then adjust the delay rate by pressing the **+** key or **-** key.

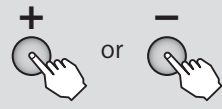

Range : **0-100%**
 Default : **0%**

- When you want to return the set value to the initial value, press the **+** key and **-** key simultaneously.



GYRO

Gyro sensor

(HELICOPTER)

Function

This mixing adjusts the gyro sensitivity from the transmitter. The AVCS gyro (AVC mode) or normal gyro (NOR mode) can be selected.

- The gain can be linked to the condition (Cond) or an arbitrary switch and set.
- When the GY mode was selected, "AVC" or "NOR" is displayed at the gain setting value.

- The sensitivity setting channel can be selected.
- T6K only 1 channel gain control.
- 3 axes gyro of gain can't be controlled independently.

Method

Calling the setting screen

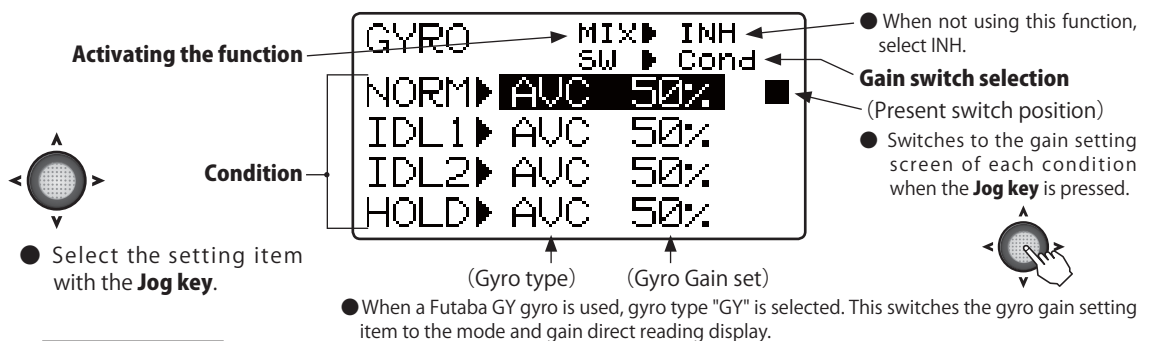

Helicopter

Gyro setup

■ Activating the function

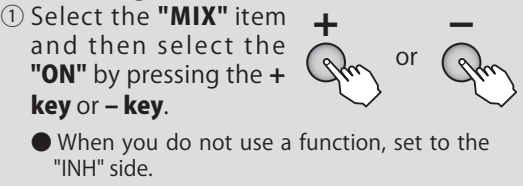

■ Gain switch selection

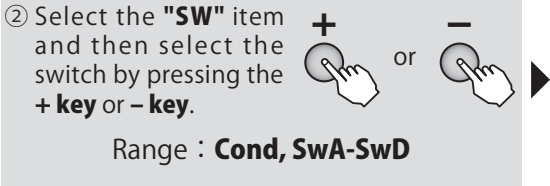

■ Gyro mode and gain setting

③ When choosing **Cond**. → Set a mode and gain every each condition.
When choosing **Switch** → UP, CNT, DWN, shows the switch position. Set the respective positional gain and mode.

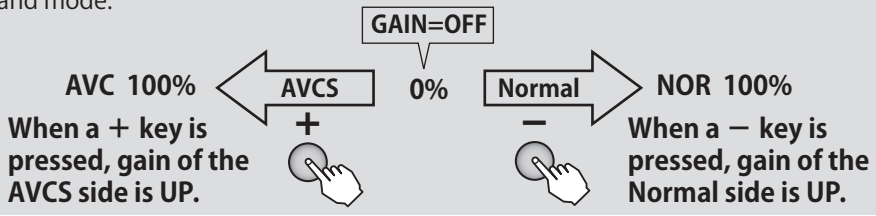



SWH AFR Swash AFR (HELICOPTER)

Function (When swash type is H-1, this setting screen is not displayed.)

This is the adjustable function rate (AFR) function when HR3, H-3, HE3, HN3 or H-2 is selected as the swash type. The ailerons, elevators, and pitch steering angle and direction can be adjusted.

Method

Calling the setting screen

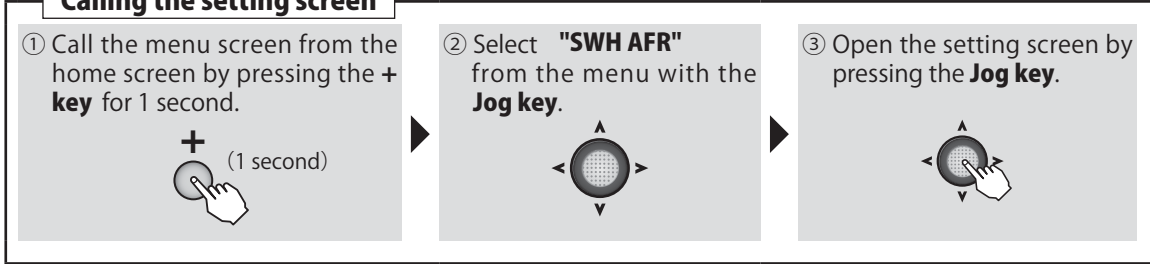

- Select the setting item with the **Jog key**.

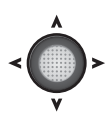

Rete

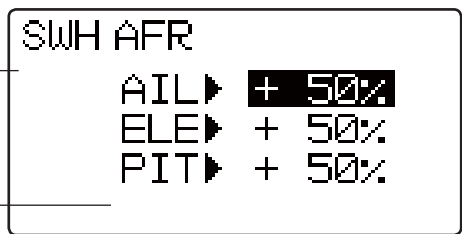

- Depending on the swash type the screen display is different.
- When the polarity is changed, the direction of operation is reversed.

NOTE : If the steering angle is too large, linkage binding may occur .

Swash AFR

■ **Travel adjustment of each function**

① Select each function item of **"RATE"** and set the rate by pressing the **+** key or **-** key.

Range : **-100 to +100%**
Default : **+50%**

● When you want to return the set value to the initial value, press the **+** key and **-** key simultaneously. However, polarity does not return.

Helicopter



SWH MIX Swash mixing (HELICOPTER)

Function

This mixing is used to correct the bad tendencies of the swash plate in the aileron direction and elevator direction relative to aileron, elevator, and pitch operations. It adjusts the rate of the direction that requires correction so that the servo operates

smoothly in the proper direction relative to each operation.

- The correction amount of each condition can be set.
- The left and right (up and down) correction amount can be set for each condition.

Example of use: Using to correct bad roll tendencies

- ① AIL → ELE is set to ON.
- ② INH/ON is common to all conditions. The rate of unused conditions is set to 0%.
- ③ When the nose drops at right roll and the right side rate is adjusted in the "+" direction, the elevators move to the up side when the right aileron is deflected. Left roll can be adjusted by left side rate.

However, since the left and right ailerons polarity and elevators operating direction relationship is reversed; check the correction direction by swash plate operation.

Method

Calling the setting screen



Helicopter

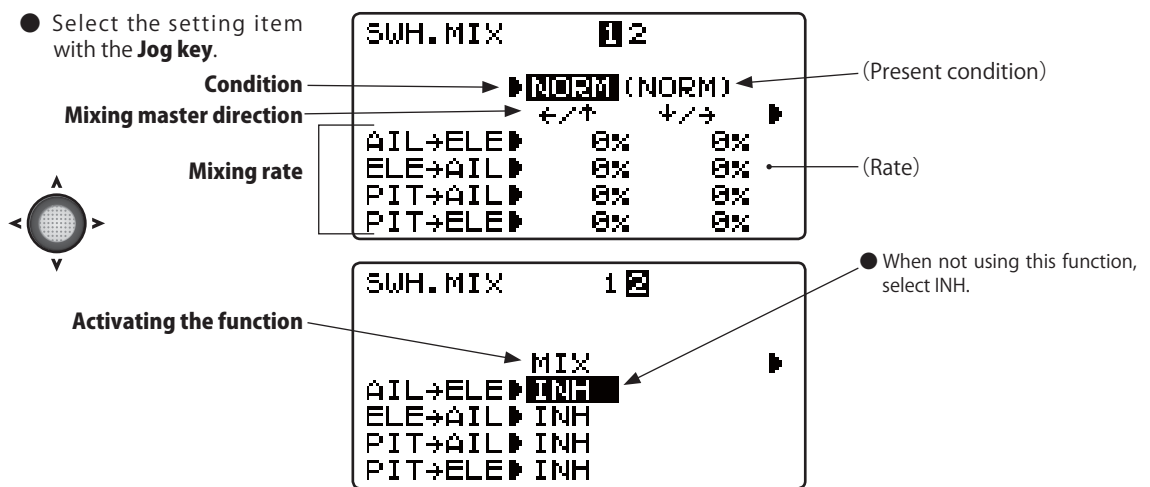



Swash mixing

■ **Activating the function**

① Select the **"MIX"** item and then select the **"ON"** by pressing the **+ key** or **- key**.

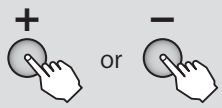

● When you are not using a function, set this to INH.

■ **Setup of rate**

② Select the **"RATE"** item and then adjust the mixing rate by pressing the **+ key** or **- key**.

Range : **-100 to +100%**
Default : **0%**

● When you want to return the set value to the initial value, press the **+ key** and **- key** simultaneously.

● ON/OFF of a function, setup of rate, and a trim, **Jog key** is pushed and setting condition can be chosen.

Range :
NORM, IDL1, IDL2, HOLD





THR CRV Throttle curve (HELICOPTER)

Function

The throttle curve function sets a 5 point curve in relation to the throttle stick movement and adjusts each point over the 0-100% range so that the engine speed is optimum for flight.

- Normal (NOR), idle up 1 (IDL1), idle up 2 (IDL2) throttle curves can be set.
- The normal (NOR), idle up 1 (IDL1), idle up 2 (IDL2) switch can be pre-set at the condition selection screen.

(Normal throttle curve adjustment method)

The normal throttle curve creates a basic throttle curve centered near hovering. This curve is adjusted together with the normal pitch curve so that engine speed is constant and up/down control is easiest. The normal throttle function is always on.

(Idle up 1/2 throttle curve adjustment method)

The idle up curves are set so that the engine maintains a constant speed even when the pitch is reduced during flight. Curves matched to the purpose such as loop, roll and 3D are created and idle up curves 1/2 are by aerobatics.

CAUTION
Operation precautions

⚠ When starting the engine, always set idle up sticks 1/2 to OFF and start the engine at idling.

Method

Calling the setting screen

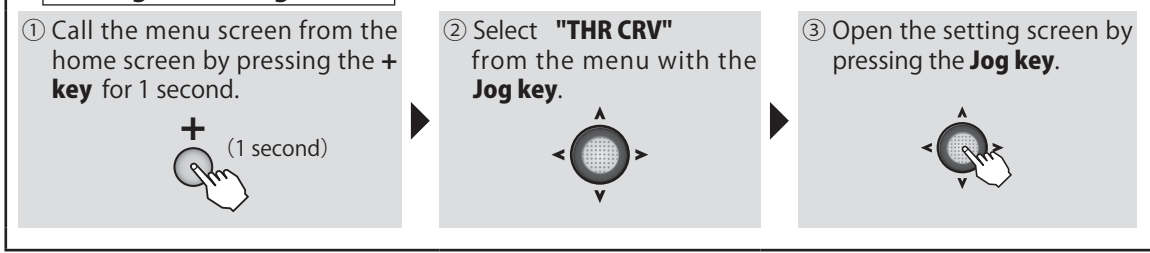

Helicopter

Activating the function

Setting condition

5 point curve rate

● Select the setting item with the **Jog key**.

● When not using this Function select INH. The display of On/Off is shown when active and assigned to a switch. A display when normal is "----"(always ON).

● The THR-CURVE settings are displayed by a curve.

(Rate) (Present condition)



Throttle curve

■ Activating the throttle curves (ID1/2)

① Select the "MIX" item and set to "ON" or "OFF" by pressing the + key or - key.

● For the normal condition, "----" is displayed. (Always ON)

● When you do not want to use an idle up curve, set to "INH".

Range : NOR, ID1, ID2

■ 5 point curve setting

② Select the setting item of each point (P-1 to P-5) with the Jog key and set the travel of each point by pressing the + key or - key.

Range : 0-100%

Default :

P-5: 100%
P-4: 75%
P-3: 50%
P-2: 25%
P-1: 0%

● When you want to return the set value to the initial value, press the + key and - key simultaneously.

■ Curve copying method

① Select the "CND" item and switch to the curve copy mode by pressing the Jog key.

② Press the + key or - key and select the copy destination condition.

③ Copy the condition by pressing the Jog key for 1 second.

● Throttle curve setting examples

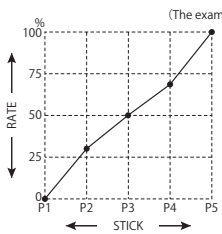

(Normal)

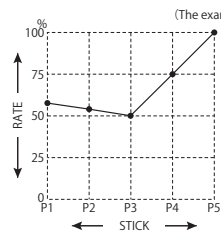

(Idle-up1)

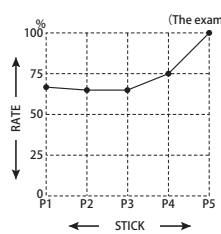

(Idle-up2)

NOTE : Set the actual value of the throttle curve according to the fuselage specifications.

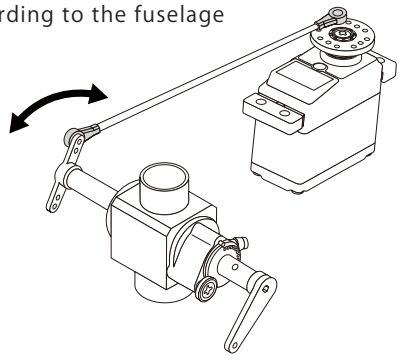



PIT CRV Pitch curve (HELICOPTER)

Function

The pitch curve function allows setting by a 5 point curve in relation to throttle stick movement and adjustment of each point over the -100% to +100% range so that the pitch enters the optimum flight state.

- Normal (NOR), idle up 1 (IDL1), idle up 2 (IDL2), and hold (HLD) pitch curves can be set.
- The normal (NOR), idle up 1 (IDL1), idle up 2 (IDL2), and hold (HOLD) switches can be pre-set at the conditions selection screen.

NOTE : When the hold switch is on, the hold function has priority even though an idle up switch is in any position.

(Normal curve adjustment method)

The normal pitch curve creates a basic pitch curve centered near hovering. This curve is adjusted together with the throttle pitch curve so that engine speed is constant and up/down control is easiest.

(Idle up 1/2 curve adjustment method)

The high side pitch curve sets the maximum pitch that does not apply a load to the engine. The low side pitch curve is created to match the purpose such as loop, roll, and 3D. The idle up 1/2 curves are used by aerobatics.

(Throttle hold curve adjustment method)

The throttle hold curve is used when performing auto rotation dives. Set the intermediate pitch to match the stick work at pitch up.

Method

Helicopter

Calling the setting screen

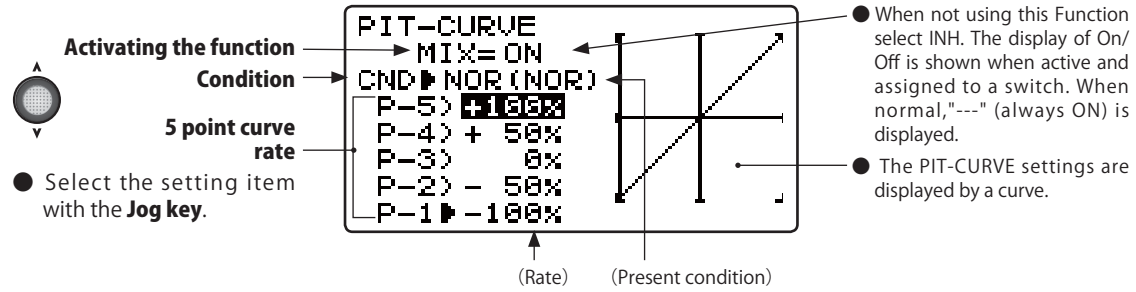
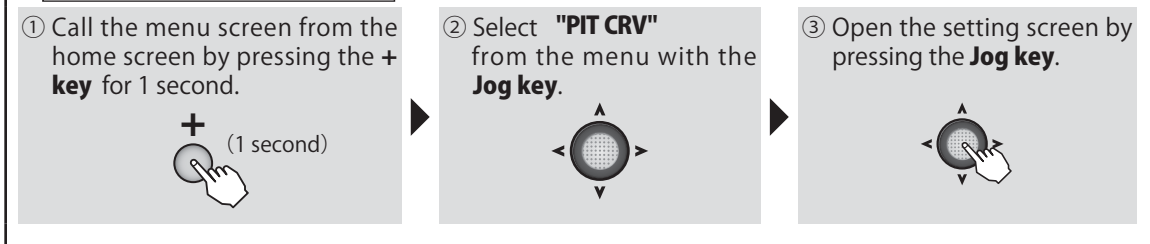



Pitch curve

■ Activating the pitch curves (ID1/2, HLD)

① Select the "MIX" item and then select the "ON" or "OFF" by pressing the **+** key or **-** key.

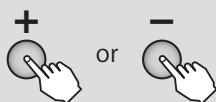

- For the normal condition, "---" is displayed. (Always ON)
- When you do not want to use an idle up, hold curve, set to "INH".

Range : **NOR, ID1, ID2, HLD**

■ 5 point curve setting

② Select the setting item of each point (P-1 to P-5) with the **Jog** key and set the travel of each point by pressing the **+** key or **-** key.

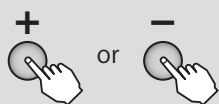

Range : **-100 to +100%**

Default :

P-5: +100%

P-4: +50%

P-3: 0%

P-2: -50%

P-1: -100%

- When you want to return the set value to the initial value, press the **+** key and **-** key simultaneously.

■ Curve copying method

① Select the "CND" item and switch to the curve copy mode by pressing the **Jog** key.



② Press the **+** key or **-** key and select the copy destination condition.



③ Copy the condition by pressing the **Jog** key for 1 second.



● Pitch curve setting examples

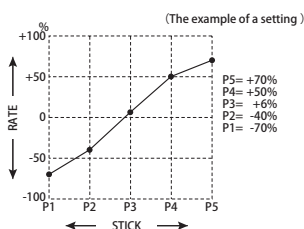

(Normal)

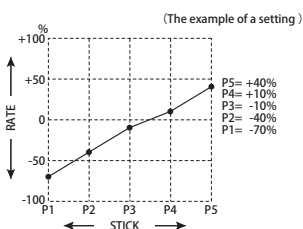

(Idle-up1)

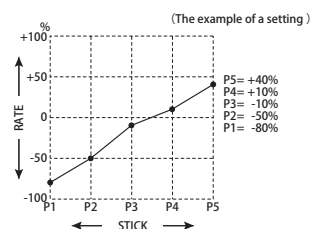

(Idle-up2)

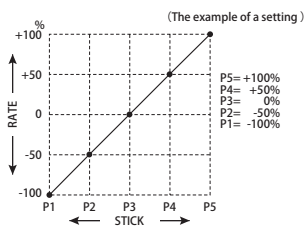

(Hold)

NOTE : Set the actual value of the pitch curve according to the fuselage specifications.

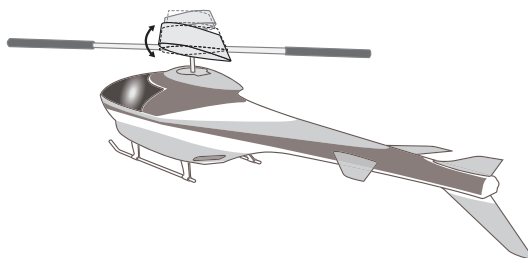



REVO MX Pitch → Rudder (Revolution) mixing (HELICOPTER)

Function

The pitch→rudder mixing function controls the pitch of the tail rotor to suppress the reaction torque (force that attempts to swing the helicopter in the direction opposite the direction of rotation of the main rotor) generated by the main rotor pitch and speed. It is adjusted so that the pitch of the tail rotor is also changed when the main rotor pitch changes and reaction torque appears and so that the nose does not swing to the left and right. However, when the AVCS mode is used with a GY Series gyro, pitch→rudder mixing is unnecessary.

- The normal (NOR) idle up 1/2 (IDL1,2) rates can be set.
 - The high side and low side rates can be adjusted.
 - For a clockwise rotation rotor, the operating direction is set so that the rudder is mixed in the right direction when the pitch becomes plus. For a counterclockwise rotation rotor, the setting is opposite. The operating direction setting reverses the rate polarity.
CW rotation: Low side (LOW) -105, high side (HIGH) +10%
CCW rotation: Low side (LOW) +10%, high side (HIGH) -10%
- *The above values are the initial values. Replace them with the actual setting values.

Adjustment procedure

First, trim at hovering and then adjust the neutral position.

(Normal pitch → rudder mixing)

● Throttle low side (slow while hovering) adjustment

Repeatedly hover from take off and land from hovering at a constant rate matched to your own rhythm, and adjust pitch → rudder mixing so that the nose does not deflect when the throttle is raised and lowered.

If the nose points to the left when landing from hovering or points to the right when taking off, when hovering stabilizes and the stick moves to the neutral position, low side mixing rate is probably too large and when the nose points in the opposite direction, low side rate is probably too small. However, when landing, the direction of the nose may not stabilize depending on the state on the ground. The direction of the nose may also become unstable when rotation of the rotor does not rise.

● Throttle high (up to climbing from hovering and diving hovering) adjustment

Repeat up to climbing from hovering and diving hovering matched to your own rhythm and adjust pitch → rudder mixing so that the nose does not deflect to the left and right when the throttle is raised and lowered. If the nose points to the right when climbing from hovering, the high side mixing rate is too large and if the nose points to the right, the mixing rate is too small. Repeat climbing and diving and make adjustment while taking the balance.

(Idle-up1/2 Pitch → Rudder mixing)

This mixing sets the mixing rate so that the rudder direction is straight forward at high speed flight.

Helicopter

Method

Calling the setting screen

① Call the menu screen from the home screen by pressing the + key for 1 second.



② Select "REVO MX" from the menu with the Jog key.

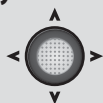

③ Open the setting screen by pressing the Jog key.





Activating the function
Selection of condition
High side Setup of rate
Low side Setup of rate

● Select the setting item with the **Jog key**.

REVO.MIX

MIX ▶ INH (NORM) ←

COND ▶ NORMAL

HIGH ▶ + 20%

LOW ▶ - 20%

(Rate)

● When not using this function, select INH.
 (present switch position)

Pitch → Rudder mixing

■ Activating the function

① Select the "MIX" item and then select the "ON" by pressing the **+ key** or **- key**.

● When you do not use a function, set to the "INH" side.

■ Selection of condition

② Select the "COND" item and selection of condition by pressing the **+ key** or **- key**.

Range : **NORM, IDL1/2**

■ Setup of rate

③ Select each function item of "HI" or "LO" and set the rate by pressing the **+ key** or **- key**.

Range : **-100 to +100%**
 Default(NORM) : **-20%(LOW) +20%(HIGH)**
 Default(IDL1/2) : **0%(LOW) 0%(HIGH)**

● When you want to return the set value to the initial value, press the **+ key** and **- key** simultaneously.

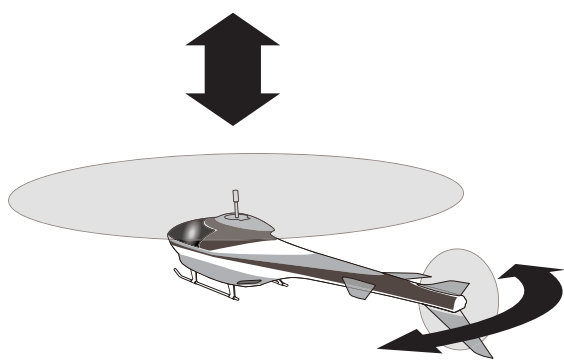



TH HOLD Throttle hold (HELICOPTER)

Function

The throttle hold function fixes or stops the engine throttle position by hold switch operation during an auto rotation dive. Operation can be set within the -50% to +50% range based on the throttle trim position.

The switch is changed at the conditions selection screen. (Initial setting: SwD)

CAUTION
[NOTE]
 ⚠ Priority is given to throttle hold over idle-up.

Method

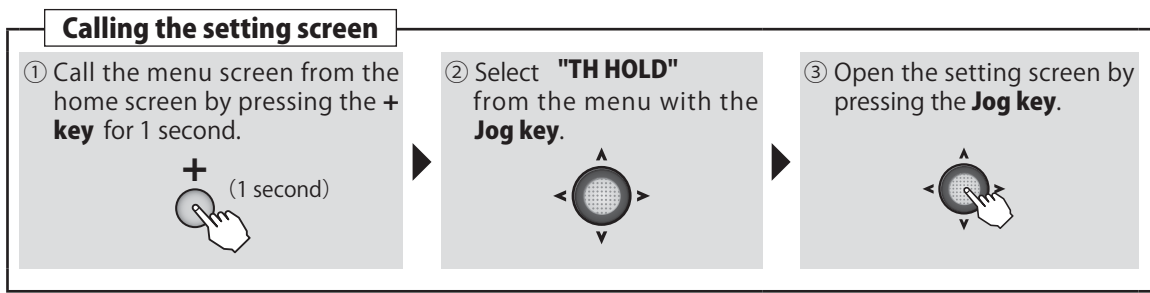

Activating the function → **hold throttle position**

THR HOLD

MIX ▶ INH ←

RATE ▶ 0%

SW ▶ SWD

POSI ▶ DOWN

- Select the setting item with the **Jog key**.
- When not using this Function select INH. The display of On/Off is shown when active and assigned to a switch.

Throttle hold

■ **Activating the function**

① Select the **"MIX"** item and then select the **"ON"** or **"OFF"** by pressing the **+** key or **-** key.

- When you do not use a function, set to the "INH" side.

■ **Hold throttle position**

② Select the **"RATE"** item and then adjust the rate by pressing the **+** key or **-** key.

Range : **-50 to +50%**
Default : **0%**

- When you want to return the set value to the initial value, press the **+** key and **-** key simultaneously.

- Function ACT ↔ INH is linked to condition THR-HOLD, and can be set at any screen.

[Hold position adjustment method]

- When you want to lower the engine idling, set to the "+" direction and adjust so that the carburetor is full open.
- When maintaining idling, set the throttle stick to the slow position and turn the hold switch on and off and set to the number at which the servo does not operate.

NOTE : When connecting the throttle linkage, lower the digital trim to the slowest and adjust so that the carburetor is full open.

Helicopter



HOV THR Hovering throttle (HELICOPTER)

Function

The hovering throttle function trims the throttle near the hovering point.

When the hovering throttle VR is turned clockwise, the speed increases and when it is turned counterclockwise, the speed decreases. Rotor speed changes due to changes in the temperature,

humidity, and other flying conditions can be trimmed. Adjust for the most stable rotor speed. More precise trimming is possible by using this function together with the hovering pitch function.

- The operation condition can be selected from only normal or normal/idle up 1.

Method

Calling the setting screen

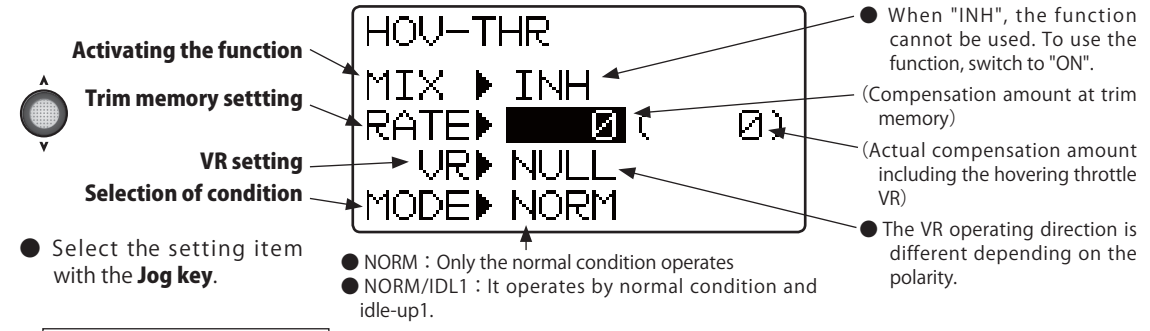
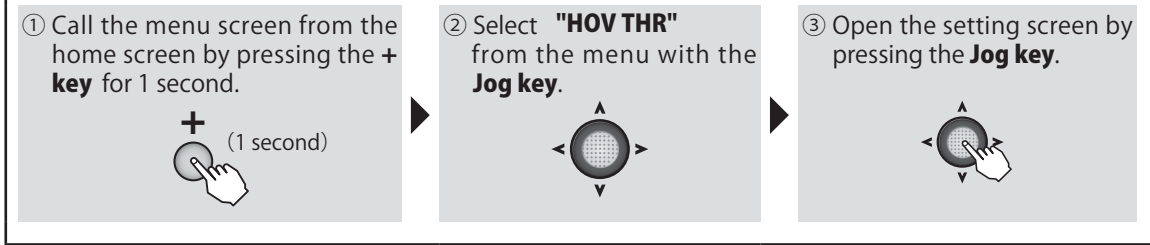

Hovering Throttle

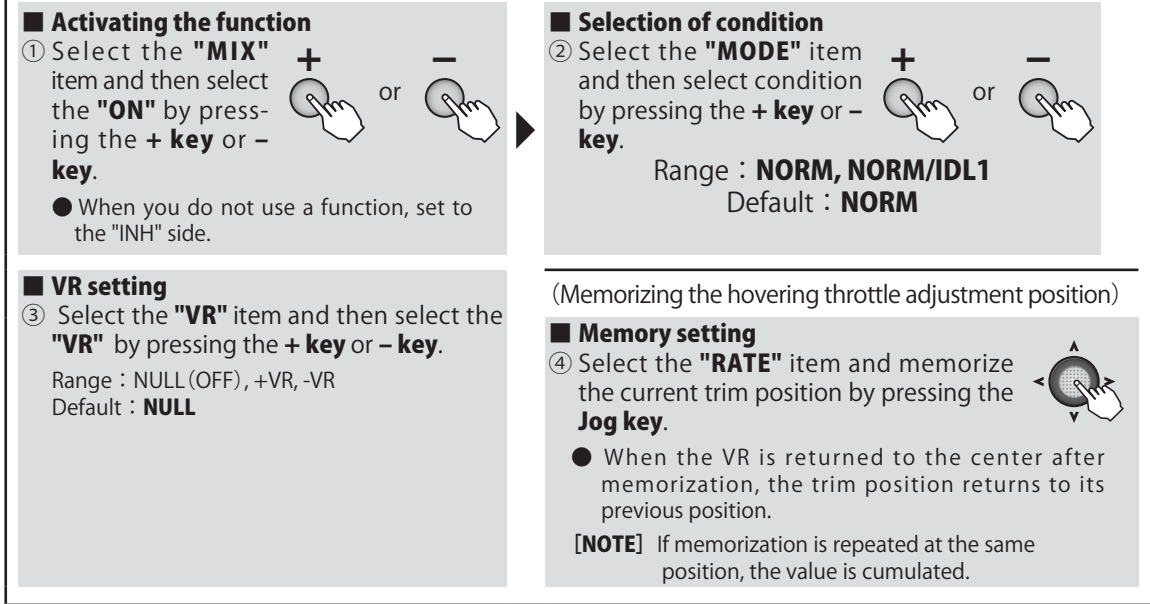

Helicopter



HOV PIT Hovering pitch (HELICOPTER)

Function

The hovering pitch function trims the pitch near the hovering point.

When the hovering pitch VR is turned clockwise, the pitch gets stronger and when it is turned counterclockwise, the pitch gets weaker. Rotor speed changes due to changes in temperature, humidity, and other flying conditions can be trimmed. Adjust for the most stable rotor rotation.

More precise trimming is possible by using this function together with the hovering throttle function.

- The operating condition can be selected from normal only and normal/idle up 1.
- The trim position can be memorized. If it is memorized before the model memory is changed, the original trim state can be retrieved by merely setting the VR to the center when the trim position is recalled.

Method

Calling the setting screen



HOV-PIT

MIX ▶ INH ← OFFSET

RATE ▶ [] ← []

VR ▶ -VR

MODE ▶ NORM

- When "INH", the function cannot be used. To use the function, switch to "ON".
- (Compensation amount at trim memory)
- (Actual compensation amount including the hovering pitch VR)
- The VR operating direction is different depending on the polarity
- Select the setting item with the **Jog key**.
- NORM : Only the normal condition operates
- NORM/IDL1 : It operates by normal condition and idle-up1.

Hovering Pitch

■ **Activating the function**

① Select the **"MIX"** item and then select the **"ON"** by pressing the **+** key or **-** key.

- When you do not use a function, set to the "INH" side.

■ **Selection of condition**

② Select the **"MODE"** item and then select condition by pressing the **+** key or **-** key.

Range : **NORM, NORM/IDL1**
Default : **NORM**

(Memorizing the hovering pitch adjustment position)

■ **VR setting**

③ Select the **"VR"** item and then select the **"VR"** by pressing the **+** key or **-** key.

Range : NULL (OFF), +VR, -VR
Default : **-VR**

■ **Memory setting**

④ Select the **"RATE"** item and memorize the current trim position by pressing the **Jog key**.

- When the VR is returned to the center after memorization, the trim position returns to its previous position.

[NOTE] If memorization is repeated at the same position, the value is cumulated.

Helicopter



Glider function

The setting screen of each function is called from the following menu. The function when the model type was set to glider (2AIL4FLP) is displayed here.

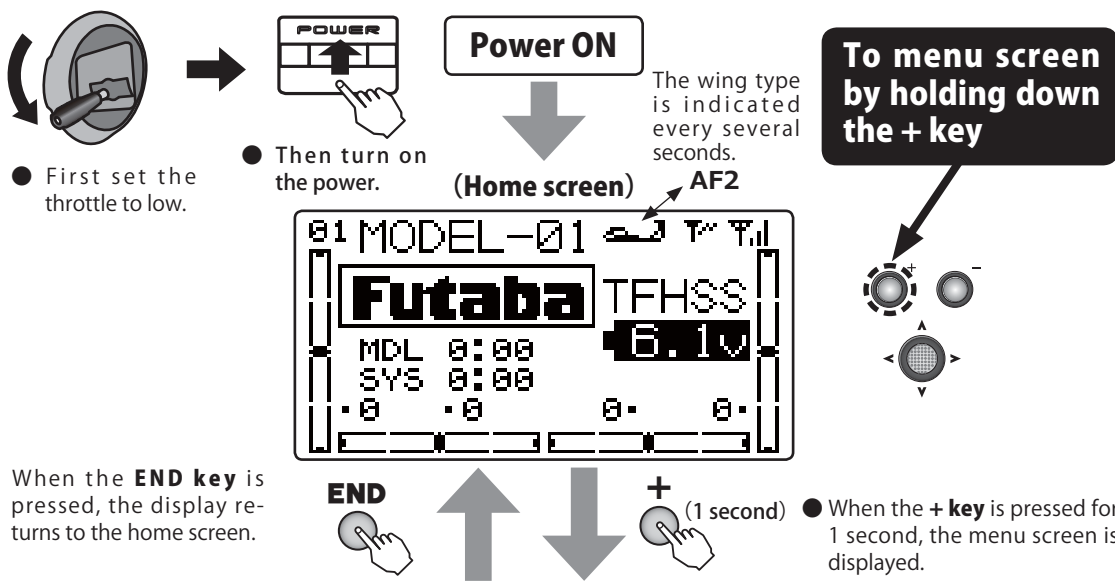

MENU

MENU 1/4

MENU 2/4

MENU 3/4

MENU 4/4

MENU 1 2 3 4

▶MDL SEL ▶E POINT

▶MDL TYP ▶TRIM

▶MDL NAM ▶SUB TRM

▶F/S ▶REVERS

MENU 1 2 3 4

▶PRMTR ▶TLMTRY

▶P.MIX ▶SENSOR

▶AUX CH ▶S.BUS

▶SERVO ▶M TRANS

MENU 1 2 3 4

▶TIMER ▶DR EXP

▶TRAINR

▶CONDIT

MENU 1 2 3 4

▶AIL DIF ▶EL→CMB

▶V-TAIL ▶CMB MIX

▶BUTFLY ▶AL→CMB

▶TRM MIX

(Selection)

● Move the cursor (highlighted) up and down and to the left and right with the **Jog key** and select the function. The cursor can be moved over several pages.

(Calling the setting screen)

● Press the **Jog key** to open the setting screen.

Glider



■ The menu items can be changed according to the WING type. For example, if WING type is 1AIL, since the item blinks, reference only the item of the WING type used.

Relevant WING type display → **WING TYPE 1AIL 1AIL1FLP 2AIL 2AIL1FLP 2AIL2FLP**

Refer to "Common Functions" previously described for a description of this function.

■ Function

◆ MENU 1/4

MDL SEL	P.52
MDL TYP	P.55
MDL NAM	P.57
F/S	P.59
E POINT	P.61
TRIM	P.62
SUB TRM	P.63
REVERS	P.64

◆ MENU 2/4

PRMTR	P.65
P.MIX	P.70
AUX CH	P.73
SERVO	P.74
TLMTRY	P.75
SENSOR	P.91
S.BUS	P.93
M TRANS	P.96

◆ MENU 3/4

TIMER	P.97
TRAINER	P.100
CONDIT	P.143
DR EXP	P.144
MOT SW	P.146
GYRO	P.147

◆ MENU 4/4

AIL DIF	P.148
V TAIL	P.149
BUTFLY	P.150
TRM MIX	P.151
EL → CMB	P.152
CMB MIX	P.154
AL → CMB	P.155

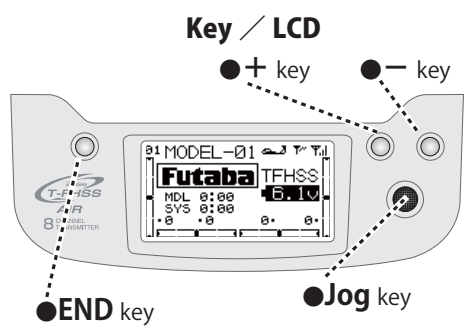



CONDIT Condition (GLIDER)

Function **WING TYPE** 1AIL1FLP 2AIL 2AIL1FLP 2AIL2FLP

The condition function lets you change multiple settings by one switch operation. Different settings can be made immediately by switching 2 conditions.

- The functions that can be changed by condition are:
 - Camber MIX • Butterfly
 - ELE→Camber • ALL→Camber
 - Trim mix

Method

Calling the setting screen

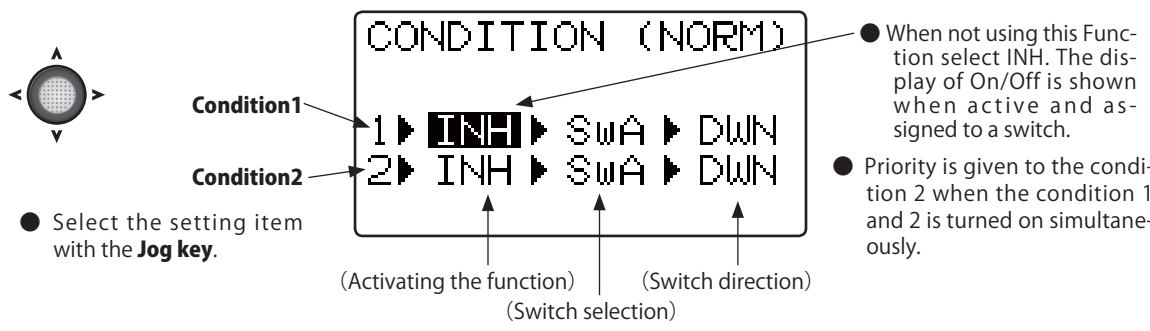
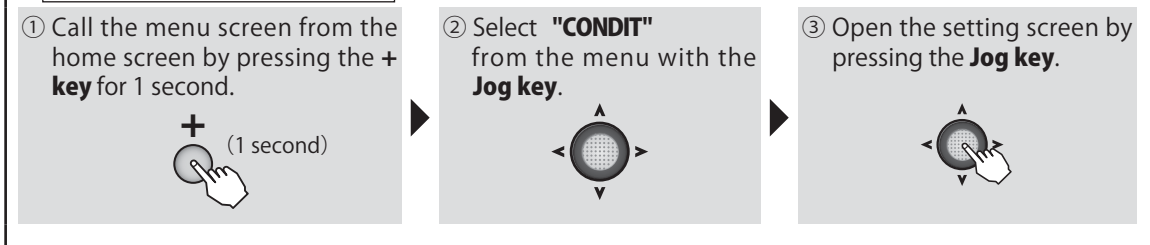

CONDITION

■ Activating the function

① Select the **"INH"** item of the condition you want to use and then set that condition to "ON" or "OFF" by pressing the **+** key or **-** key.

● Set conditions you do not want to use to "INH".

■ Switch selection

② Change the switch by pressing the **+** key or **-** key at the switch selection item.

Range : **SwA-SwD**
Default : **SwA**

■ Switch direction

③ Select the ON direction by pressing the **+** key or **-** key at the ON direction selection item.

Range :

- 2P SW : **NUL, UP, DWN**
- 3P SW : **NULL, UP, U&D, U&C, CNT, C&D, DWN**





DR EXP Dual rate / EXPO (GLIDER)

WING TYPE 1AIL 1AIL1FLP 2AIL 2AIL1FLP 2AIL2FLP

Function

D/R

The aileron, elevator and rudder channel control surface angle can be switched in 2(3) steps

- The control surface angle is adjusted by each direction of the switch. The direction of each switch can be set individually.

EXP

This function makes operation more pleasant by changing the operating curve so that servo movement is sluggish or sensitive relative to stick operation near the aileron, elevator, throttle, and rudder neutral position. Adjustments can be made in 2(3) steps according to the control surface angle.

- The "-" side makes servo movement sluggish and the "+" side makes servo movement sensitive near the neutral position. Exponential is applied to entire throttle servo travel. When the "+" side is increased, the slow side becomes sluggish and the high side becomes sensitive.
- Setting corresponding to each rate of dual rate (D/R) is possible. (Except throttle) The direction of each switch and the left and right (up and down) direction of each channel can be set individually.

Switch selection (SW)

Switches A to D can be selected as the aileron channel, elevator channel, and rudder channel dual rate (exponential) switch.

- Default : Aileron : SwitchD / Elevator : SwitchA / Rudder : SwitchB

Method

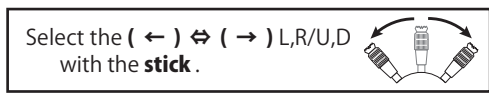
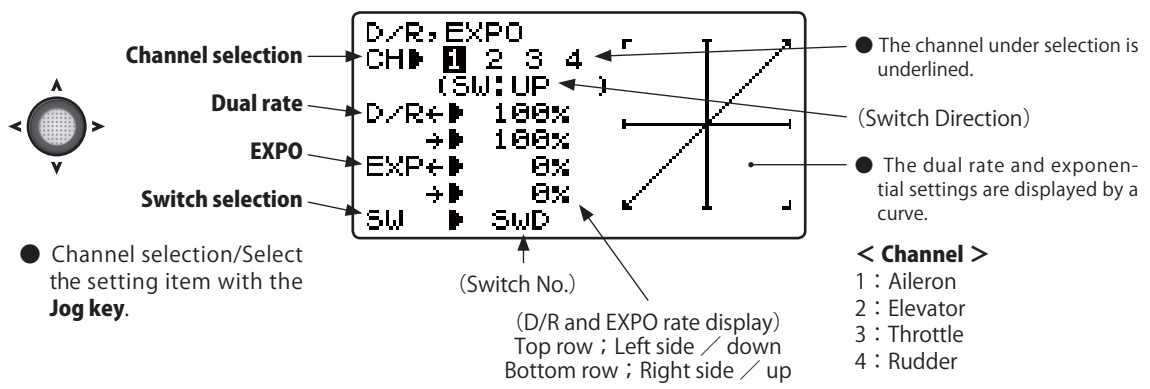
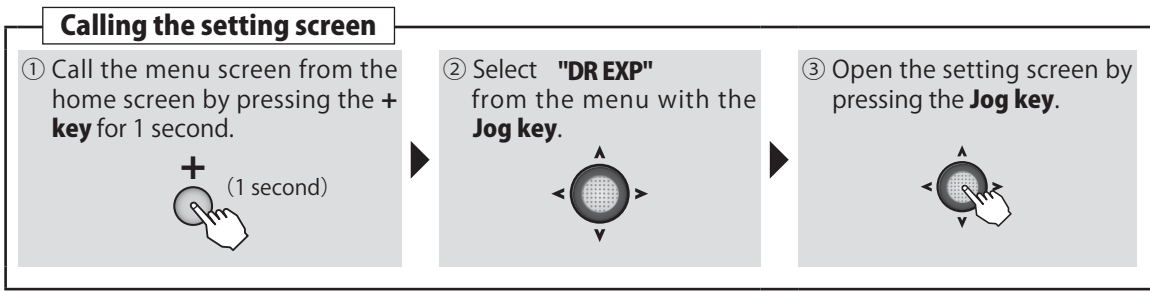

Glider



D/R

① A channel is chosen by **Jog key**.



Range : **1, 2, 4**

② Adjust the rate by moving the cursor to D/R with the **Jog key**, switching the dual rate switch to the direction you want to set, moving the stick to the left (down) or right (up) side and pressing the **+ key** or **- key**.



Range : **0-140%**
Default : **100%**

- When you want to return the set value to the initial value, press the **+ key** and **- key** simultaneously.

Adjust the rate of each direction of the dual rate switch and stick by repeating step

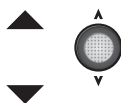

- Moving to another setting item of the same channel is possible by **Jog key**.

EXPO

① Select the "**EXP**" item and then select the channel with the **Jog key**.



Range : **1-4**

② Adjust the rate by moving the cursor to EXP with the **Jog key**, switching the dual rate switch to the direction you want to set, moving the stick to the left (down) or right (up) side and pressing the **+ key** or **- key**.



Range : **-100 to +100%**
Default : **0%**

- When you want to return the set value to the initial value, press the **+ key** and **- key** simultaneously.

Adjust the rate of each direction of the dual rate switch and stick by repeating step

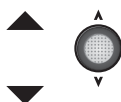

- Moving to another setting item of the same channel is possible by **Jog key**.

Switch Change

① Select the "**SW**" item and then select the channel with the **Jog key**.



Range : **1, 2, 4**

② A switch is chosen by **+ key** or **-key**.



Range : **SwA-SwD**



MOT SW Motor switch (GLIDER)

WING TYPE 1AIL 1AIL1FLP 2AIL 2AIL1FLP

Function

This function sets the operating motor when the EP glider with motor is started by switch. The operating speed can individually set in 2 ranges of high from slow and slow from high. **If you do motor control with a throttle stick, you should set this function to INH.**

- For safety, the ON/OFF switch of the aircraft itself can be set.
- If a transmitter power supply is switched on while the motor SW has been ON, the warning will operate. Be sure to switch on a power supply with the motor-start switch OFF.

Method

Calling the setting screen

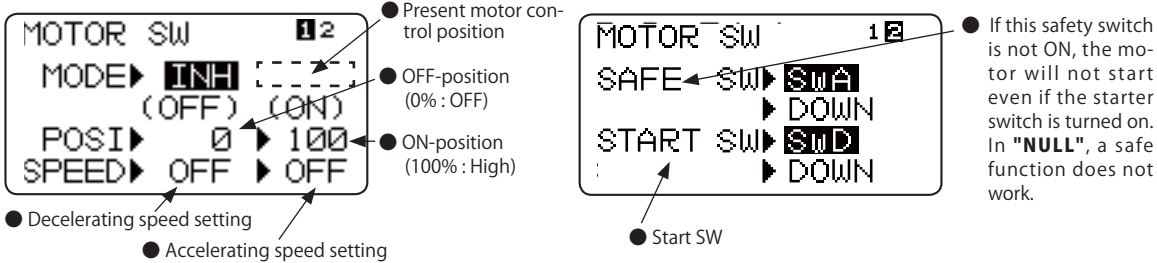
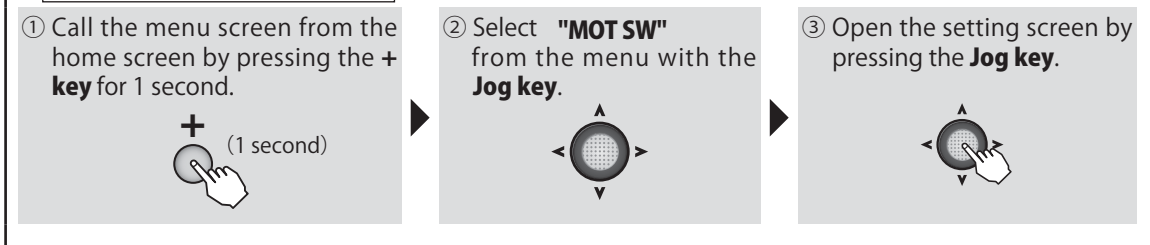

Motor

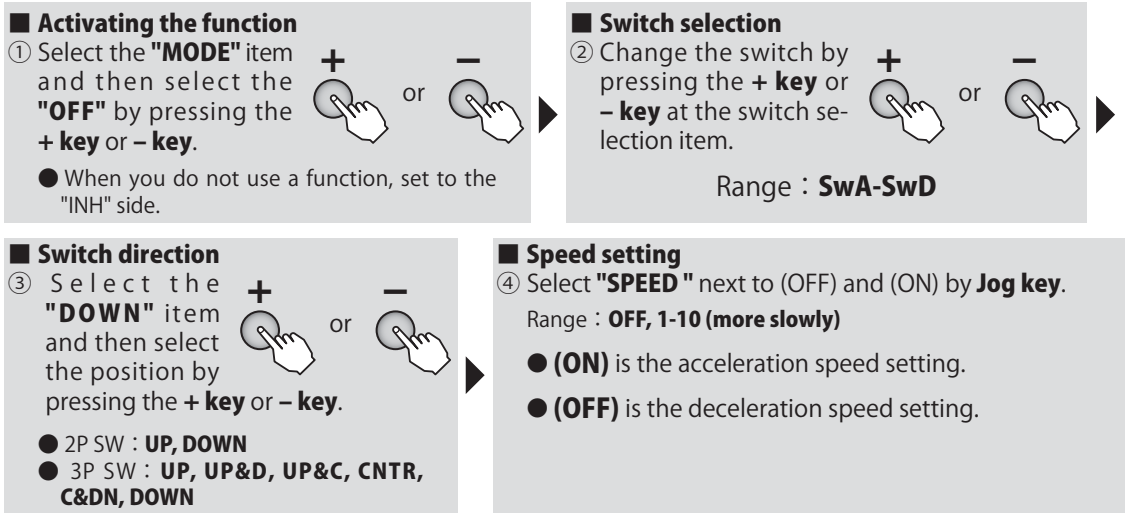

⚠ DANGER

Always remove the propeller from the motor during setting and at operation checks.

- There is the danger of the propeller spinning unexpectedly and causing a serious injury.

Glider



GYRO

Gyro sensor

(GLIDER)

WING TYPE

TAIL

ZAIL

Function

This function is dedicated mixing for switching the gyro sensitivity and gyro mode (AVCS/NORMAL) of Futaba airplane use gyros.

- The sensitivity switch can be selected and the sensitivity of each direction of the switch can be set. (Switches A to D) If the airplane stalls during flight, the gyro will lose control of the plane's

attitude. From the standpoint of safety, we recommend that the OFF (0%) position also be set using a 3 position switch.

Method

Calling the setting screen

- ① Call the menu screen from the home screen by pressing the **+** key for 1 second.



- ② Select "GYRO" from the menu with the **Jog key**.

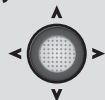

- ③ Open the setting screen by pressing the **Jog key**.



Each switch position
Gyro type / Gain rate

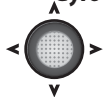

- Select the setting item with the **Jog key**.

GYRO	MIX ▶ INH	←
	SW ▶ SwB	←
UP ▶ NOR	40%	←
CNT ▶ NOR	20%	←
DWN ▶ NOR	10%	←

(Gyro type)

(Gyro Gain)

- When not using this function, select INH.

Gain switch selection

(Current switch operating direction)

- Switches to the sensitivity setting screen of each switch direction when the **Jog key** is pressed.



GYRO setup

■ Activating the function

- ① Select the "MIX" item and then select the "ON" by pressing the **+** key or **-** key.

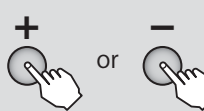

- When you do not use a function, set to the "INH" side.

■ Gain switch selection

- ② Select the "SW" item and then select the switch by pressing the **+** key or **-** key.



Range : SwA-SwD Default : SwB

■ Gyro mode and gain setting

- ③ UP, CNT, DWN, shows the switch position. Set the respective positional gain and mode.

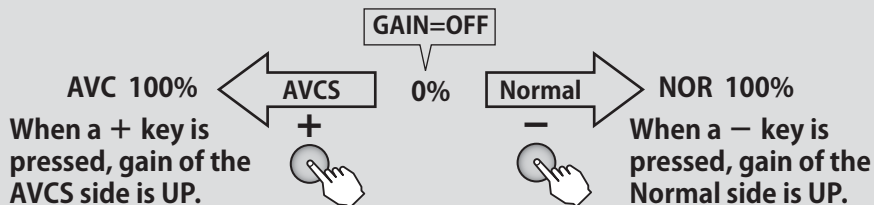

Glider



AIL DIF Aileron differential (GLIDER)

WING TYPE **2AIL** **2AIL1FLP** **2AIL2FLP**

Function

Two servos can be used for ailerons and a differential can be applied to left and right aileron operation. The left and right aileron differential can be adjusted independently. This function is restricted to 2 servo aileron.

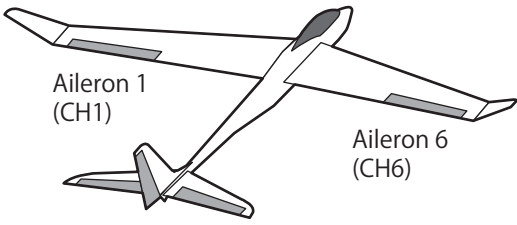

Connect the left aileron to CH1 (AIL) and the right aileron to CH6.

- The up and down angle of the left and right aileron control surface can be adjusted individually.

Method

Calling the setting screen

① Call the menu screen from the home screen by pressing the **+** key for 1 second.

② Select "AIL DIF" from the menu with the **Jog** key.

③ Open the setting screen by pressing the **Jog** key.

AIL DIF

	(L)	(R)	
Aileron 1 (CH1) rate → AIL1 ▶	+100	+100	(Aileron rate) L : Aileron Stick Left side rate R : Aileron Stick Right side rate
Aileron 6 (CH6) rate → AIL6 ▶	+100	+100	

- Select the setting item with the **Jog** key.

Select the Left/Right with the aileron stick.

Aileron Differential

■ **Activating the function**

① Select the "2AIL" or "2AIL1FLP" "2AIL2FLP" by WING type (MDL TYP).

■ **Aileron rate**

② Select the "AIL1" item and move the aileron stick to the left and right and adjust the travel of each servo by pressing the **+** key or **-** key.

or

Range : -120 to +120%
Default : +100%

- When you want to return to the initial value, press the **+** key and **-** key simultaneously. However, when the polarity is changed only the number returns to the initial value.

(Adjust the "AIL6" item in the same way as ②.)



V-TAIL V-Tail (GLIDER)

Function WING TYPE 1TAIL 1AIL1FLP 2AIL 2AIL1FLP 2AIL2FLP

This mixing is used with V tail aircraft that combine the elevator and rudder functions.

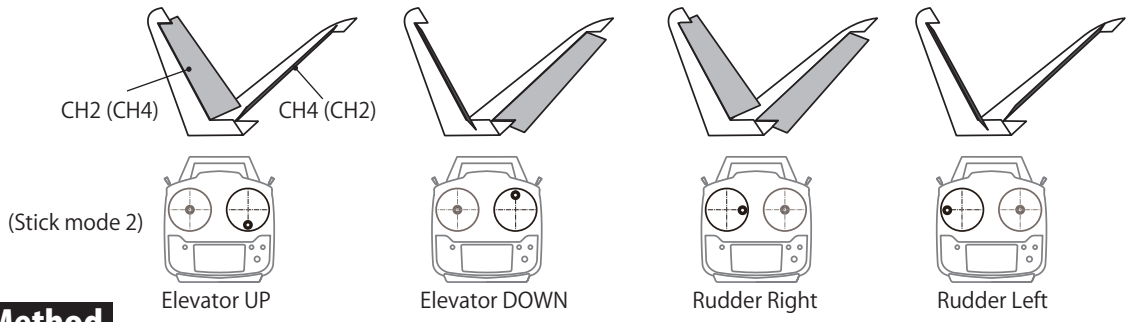

Method

Calling the setting screen

- Call the menu screen from the home screen by pressing the **+** key for 1 second.
- Select **"V-TAIL"** from the menu with the **Jog** key.
- Open the setting screen by pressing the **Jog** key.

Activating the function

	U-TAIL	MIX	INH
ELE2 rate	ELE	ELE2	+ 50
ELE4 rate		ELE4	- 50
RUD2 rate	RUD	RUD2	+ 50
RUD4 rate		RUD4	+ 50

When INH is selected, the function cannot be used. To use the function, select ACT.

(Rate adjustment)

- Select the setting item with the **Jog** key.

V-TAIL

- Activating the function**
 - Select the **"MIX"** item and then select the **"ACT"** by pressing the **+** key or **-** key.

When you do not use a function, set to the "INH" side.
- Rate adjustment**
 - Select the value item and then adjust the mixing rate by pressing the **+** key or **-** key.

Range : -100 to +100%
Default : +50%
(only ELE4 : -50%)

When you want to return the set value to the initial value, press the **+** key and **-** key simultaneously. However, polarity does not return.

NOTE : We recommend that setting be performed while moving the stick and checking the amount of movement. If the amount of movement is too large, elevator and rudder operation will be compounded and the servo travel range will be exceeded and a dead band in which the servo will not operate may be created.

Glider



BUTFLY Butterfly mixing (GLIDER)

Function

This function is utilized to quickly slow the aircraft and reduce altitude by simultaneously raising the left and right ailerons and lowering the flap.

Butterfly (Crow) produces an extremely efficient landing configuration by accomplishing the following:

WING TYPE 1AIL1FLP 2AIL 2AIL1FLP 2AIL2FLP

1. Slow the aircraft's velocity.
2. Provide washout at the wing tips to reduce the tendency to tip stall.
3. Create more lift toward the center of the wing allowing it to fly at a slower speed
 - Mixing during flight can be turned ON/OFF by setting a switch.
 - The point at which the butterfly operation reference point can be offset.
 - The differential rate can be adjusted.

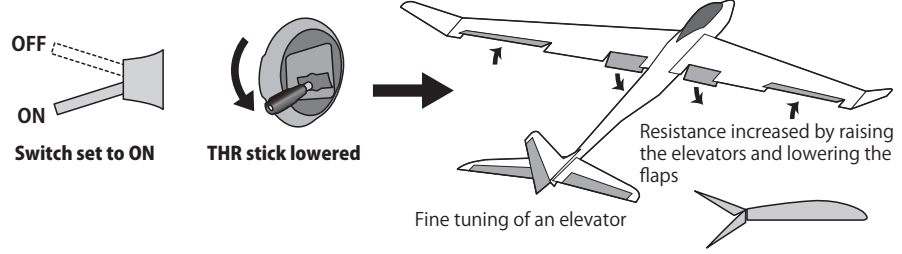

Method

Calling the setting screen

- ① Call the menu screen from the home screen by pressing the **+** key for 1 second.
- ② Select **"BUTFLY"** from the menu with the **Jog key**.
- ③ Open the setting screen by pressing the **Jog key**.

Amount of movement setting

- Aileron
- Flap
- Elevator

● Butterfly : ACT/INH

● When MIX is set to ACT, the amount of MIX(s) according to stick operation is displayed.

● Can be either set to a switch or when NULL is controlled by the THR stick.

● Current THR stick position 0% : Low 100% : High

● It can't be set. < It's caused by the wing type. >

(Currently selected condition)

● Offset setting -Select "OFST" XX%.

At THR stick high press the **Jog key** for 1 second

OFST ▶ 100%

Brake amount MAX

High Slow THR stick operation

At THR stick 60% press the **Jog key** for 1 second

OFST ▶ 60%

Brake amount MAX

Start from 60%

High Slow THR stick operation

● Select the setting item with the **Jog key**.

+

-

● The value is changed by **+ key or - key**.

● When offset is set below a center, the mixing of THR stick operates by the high side.

Glider



TRM MIX Trim mix (GLIDER)

WING TYPE 1AIL1FLP 2AIL 2AIL1FLP 2AIL2FLP

Function

This function shifts the ailerons, elevator, and each flap trim to the preset position by means of a switch.

The servo speed at which trim is to the set position can be set.

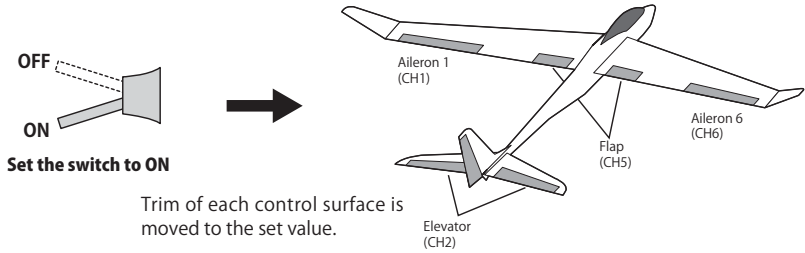

Method

Calling the setting screen

- Call the menu screen from the home screen by pressing the **+** key for 1 second.
- Select **"TRM MIX"** from the menu with the **Jog key**.
- Open the setting screen by pressing the **Jog key**.

- Select the setting item with the **Jog key**.
- The value is changed by **+** key or **-** key.

Activating the function

- When not using this function, select **INH**.

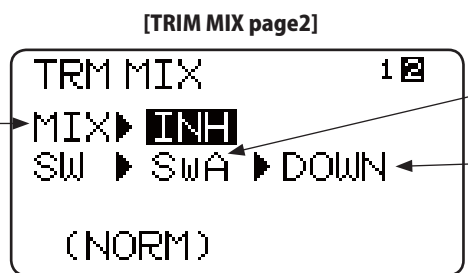
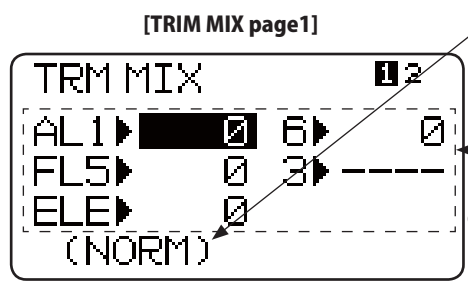

- When condition is used, the display can be switched and each connection can be set by switching the condition switch.
- Sets the trim neutral position of each control surface. Range: **-100 to +100**. Returned to 0 by pressing the **+** key and **-** key simultaneously.
- The ON/OFF switch can be changed. (Selected with the **Jog key** and changed with the **+** key)
- Sets the ON/OFF direction of the selected switch.

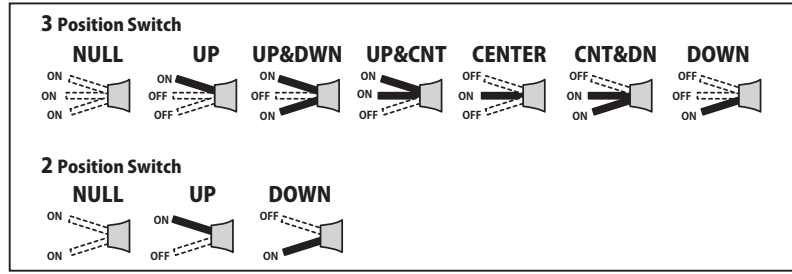

Glider



EL → CMB Elevator → Camber mixing (GLIDER)

Function

This function is used when you want to mix the camber flaps with elevator operation. When used, the flaps are lowered by up elevator, and lift is increased.

WING TYPE **2AIL 2AIL1FLP 2AIL2FLP**

- In-flight mixing can be turned ON/OFF by assigning this to a switch. (Always ON at SW [NULL] setting)
- The mixing rate can be adjusted.
- Setting so that the flaps is not operated near the center of the elevators is possible. (RANGE)

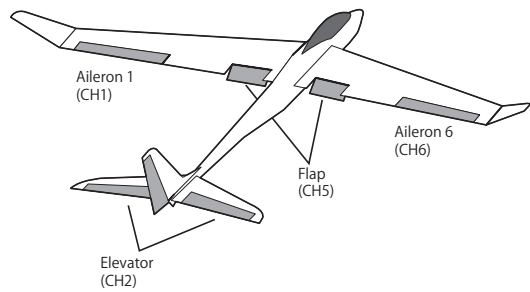
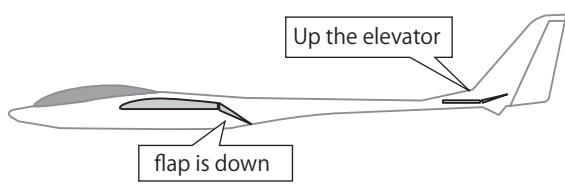

Method

Calling the setting screen

- ① Call the menu screen from the home screen by pressing the **+** key for 1 second.
- ② Select "EL → CMB" from the menu with the **Jog key**.
- ③ Open the setting screen by pressing the **Jog key**.

(Currently selected condition)

Mixing rate	EL → CMB	(NORM)	1 2
		(RT1)	(RT2)
● Aileron 1	AL1	<input checked="" type="checkbox"/>	<input type="checkbox"/>
● Aileron 6	AL6	<input type="checkbox"/>	<input type="checkbox"/>
● Flap 5	FL5	<input type="checkbox"/>	<input type="checkbox"/>
● Flap 3	FL3	<input type="checkbox"/>	<input type="checkbox"/>

● It can't be set. < It's caused by the wing type. >

● (RT1) and (RT2) show the direction of elevator of operation.

● Select the setting item with the **Jog key**.

● The value is changed by **+** key or **-** key.

[ELE → Camber 2 page]

(Currently selected condition)

	EL → CMB	(NORM)	1
● Camber MIX ACT/INH	MIX	<input checked="" type="checkbox"/>	
● Can be either set to a switch or when NULL is always active.	SW	SWA	DOWN
	RANGE	0%	
		(0%)	

● When condition is used, the display can be switched and each connection can be set by switching the condition switch.

● Sets the ON/OFF direction of the selected switch.

● Described on the next page.

● Current position of the elevator stick



[ELE → Camber 2 page]

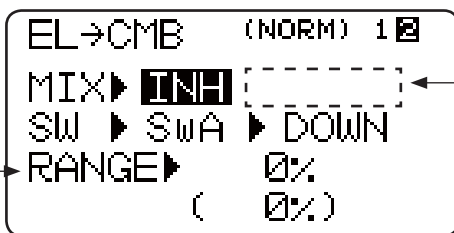

● When MIX is set to ACT, the amount of MIX(s) according to stick operation is displayed.

● Setting that inhibits camber mixing near the elevator center position. Setting so that camber mixing is performed only when the elevators were operated greatly is possible.

RANGE setting

■ Setting state

① Select the "0%" item next to RANGE with the **Jog key**.

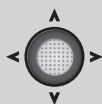

■ To setting value

② Move the elevator stick to the position you want operation to begin.



Can be either up or down. When set to down, the up side is also set by the same amount.

■ Set value memorization

③ Press the **Jog key** for 1 second.



Hold the stick in position.

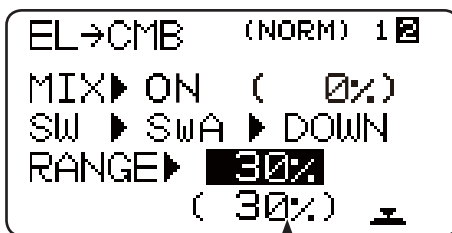

When elevator operation exceeds the range, the stick position is displayed and mixing is performed.

● When a RANGE number is selected and the **Jog key** is pressed for 1 second, RANGE is reset to 0% and normal mixing is performed.

● Use example of RANGE

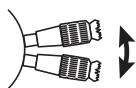

Elevator Operation



Only an elevator moves in case of a little operation.

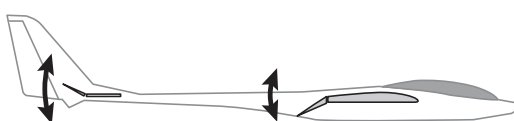
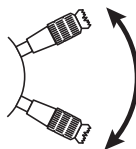

Elevator and flap move in case of big operation.



CMB MIX Camber mixing (GLIDER)

Function WING TYPE 1AIL1FLP 2AIL1FLP 2AIL2FLP

This function adjusts the rate of camber operation for the wing camber (ailerons, flap) in the negative and positive directions. The aileron, flap, and elevator rates can also be adjusted independently and attitude changes caused by camber operation can be corrected.

- Initial setting assigns camber operation to VR.
- Operation can be turned on and off by switch
- VR can be changed by AUX channel 5

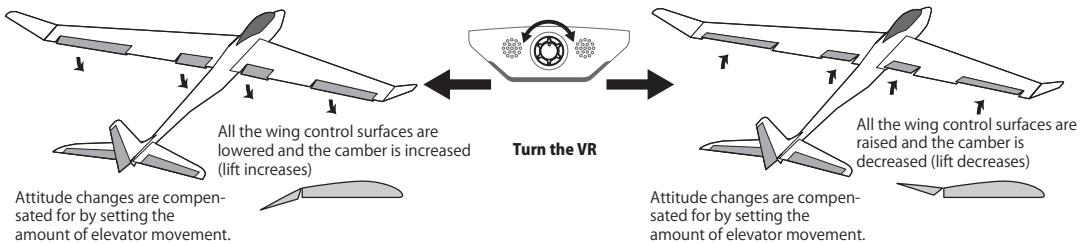

Method

Calling the setting screen

- Call the menu screen from the home screen by pressing the **+** key for 1 second.
- Select **"CMB MIX"** from the menu with the **Jog key**.
- Open the setting screen by pressing the **Jog key**.

Sets the amount of movement when the VR was turned.

• Aileron 1	AL1	<input checked="" type="checkbox"/>	▶	<input type="checkbox"/>
• Aileron 6	AL6	<input type="checkbox"/>	▶	<input type="checkbox"/>
• Flap 5	FL5	<input type="checkbox"/>	▶	<input type="checkbox"/>
• Flap 3	FL3	---	▶	---

(RT1) : The amount of operations when VR is turned to the right. (RT2) : The amount of operations when VR is turned to the left.

• Select the setting item with the **Jog key**.

• The value is changed by **+** key or **-** key.

[CMB MIX 2 page] (Currently selected condition)

• Amount of compensation of the elevator when the camber changed.	ELE	<input checked="" type="checkbox"/>	▶	<input type="checkbox"/>
• Camber MIX ACT/INH	MIX	INH		
• Can be set to operate from a switch. When NULL, it is operated by a VR.	SW	SWA	▶	DOWN

• When condition is used, the display can be switched and each connection can be set by switching the condition switch.

• Sets the ON/OFF direction of the selected switch.

Glider



AL → CMB Aileron → Camber mixing (GLIDER)

2AIL2FLP

Function

This mixing links the camber flaps with aileron operation (stick). It is used when you want to increase roll axis maneuverability.

• When the mixing direction is reversed by the linkage, adjustments can be made by changing the rate polarity.

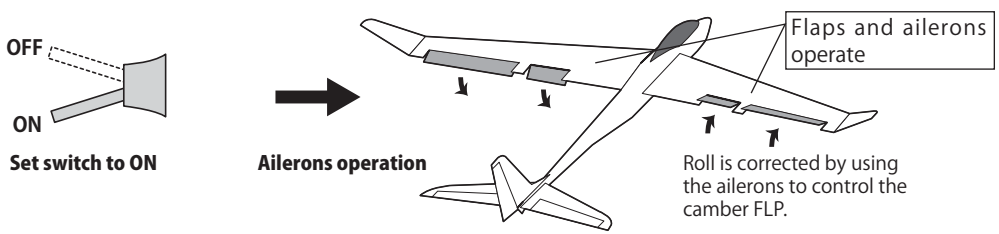

Method

Calling the setting screen

- Call the menu screen from the home screen by pressing the **+** key for 1 second.
- Select **"AL → CMB"** from the menu with the **Jog key**.
- Open the setting screen by pressing the **Jog key**.

Mixing rate

- Select the setting item with the **Jog key**.
- When not using this function, select INH.
- When condition was used, the display can be switched and each connection can be set by switching the condition switch.
- The ON/OFF switch can be changed. (Selected with the **Jog key** and changed with the +key)
- Sets the ON/OFF direction of the selected switch.

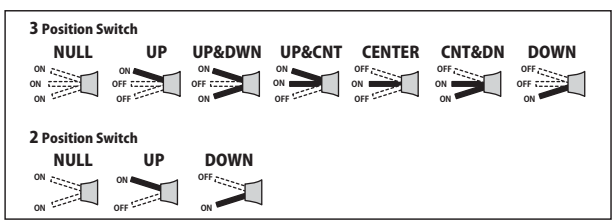

AIL → Camber mixing

- **Activating the function**
 - Select the **"MIX"** item and then select the **"ON"** by pressing the **+** key or **-** key.
 - When you do not use a function, set to the **"INH"** side.
- **Mixing rate**
 - Select the value item and then adjust the mixing rate by pressing the **+** key or **-** key.
 - Range : **-120 to +120%**
Default : **0%**
 - When you want to return the set value to the initial value, press the **+** key and **-** key simultaneously.



Glider

Multicopter Function



The setting screen of each function is called from the following menu. The function when the model type was set to multicopter (MULTI COPT) is displayed here.

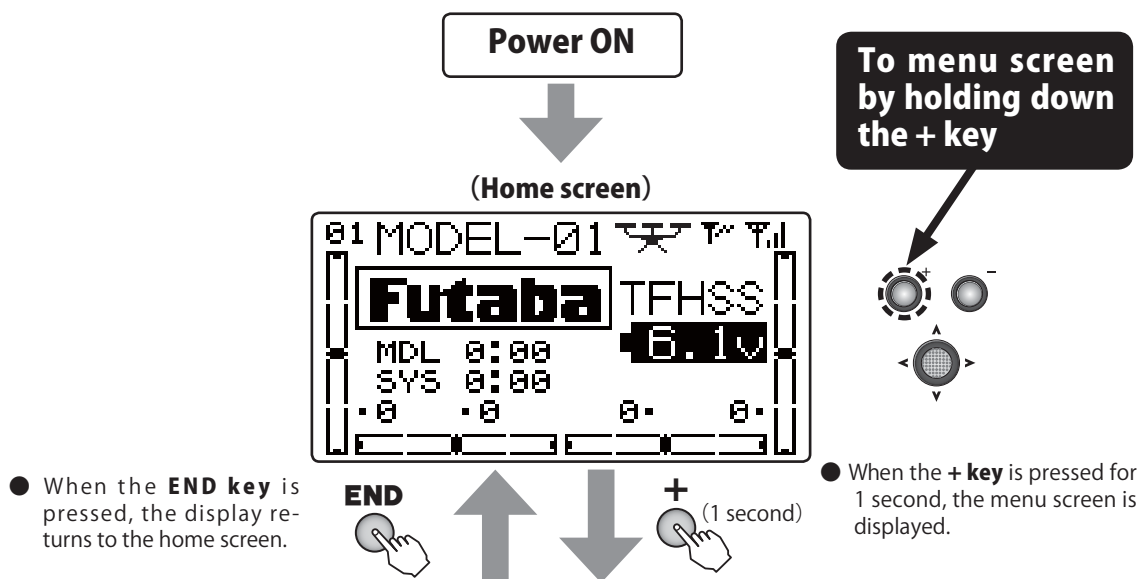

MENU

MENU 1/3

```

MENU  TFHSS  1 2 3
▶MDL SEL▶E POINT
▶MDL TYP▶TRIM
▶MDL NAM▶SUB TRM
▶F/S    ▶REVERS
          
```

MENU 2/3

```

MENU  TFHSS  1 2 3
▶PRMTR ▶TLMTRY
▶P.MIX ▶SENSOR
▶AUX CH▶S.BUS
▶SERVO ▶M TRANS
          
```

MENU 3/3

```

MENU  TFHSS  1 2 3
▶TIMER ▶DR EXP
▶TRAINR▶THR CRV
▶FLY MOD▶THR DLY
▶CNT ALM▶GYRO
          
```

(Selection)

● Move the cursor (highlighted) up and down and to the left and right with the **Jog key** and select the function. The cursor can be moved over several pages.

(Calling the setting screen)

● Press the **Jog key** to open the setting screen.

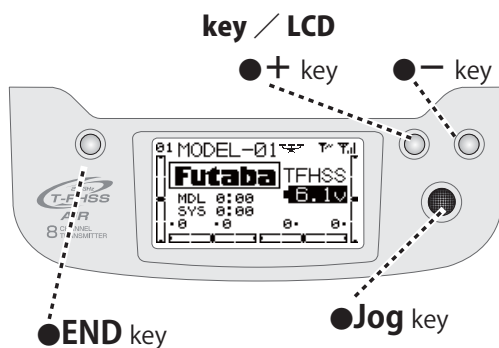

Refer to "**Common Functions**" previously described for a description of this function.

■ **Function**

◆ **MENU 1/3**

MDL SEL	P.52
MDL TYP	P.55
MDL NAM	P.57
F/S	P.59
E POINT	P.61
TRIM	P.62
SUB TRM	P.63
REVERS	P.64

◆ **MENU 2/3**

PRMTR	P.65
P.MIX	P.70
AUX CH	P.73
SERVO	P.74
TLMTRY	P.75
SENSOR	P.91
S.BUS	P.93
M TRANS	P.96

◆ **MENU 3/3**

TIMER	P.97
TRAINER	P.100
FLY MOD	P.158
CNT ALM	P.160
DR EXP	P.161
THR CRV	P.163
THR DLY	P.164
GYRO	P.165



FLY MOD Flight mode

(MULTICOPT)

Function

This flight mode is used for controlling the multi-copter connected to 6-8CH.

5-9 can be changed to a flight mode by the chosen 2 switches. It's used in case of a controller of a multicopter of the type to which the flight mode can be changed.

Method

Calling the setting screen

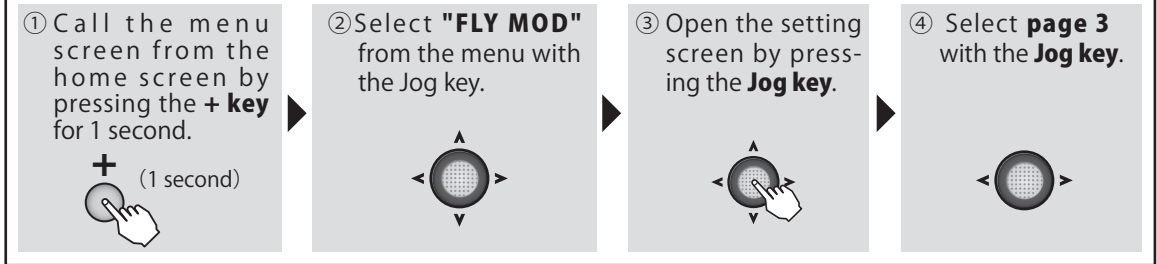

- When not using channel select INH. The display of ACT is shown when active and assigned to a channel.

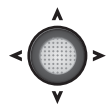

- Select the channel used for a flight mode.

- Select the setting item with the **Jog key**.

Page 3

FLY MOD		1 2 3
TYPE	PRIORITY	(MAX5)
CH5	INH	
CH6	ACT	
CH7	INH	
CH8	INH	

- 5 flight modes can be set to PRIORITY type. 9 flight modes can be set to MATRIX type.

Multicopter

TYPE

Type selection

Change the type by pressing the **+ key** or **- key** at the type selection item.

Range : **PRIORITY** or **MATRIX**

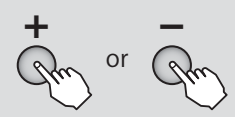

Page 1

FLY MOD		1 2 3		
	CH5	CH6	CH7	CH8
→NOR:	---	100	---	---
FM1:	---	80	---	---
FM2:	---	60	---	---
FM3:	---	40	---	---
FM4:	---	20	---	---

- The mode change rate of the multicopter control box (CH6 use)

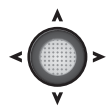

- Select the flight mode to change the rate.

- Select the setting item with the **Jog key**.

RATE

Type selection

Select the **"RATE"** item and then adjust the rate by pressing the **+ key** or **- key**.

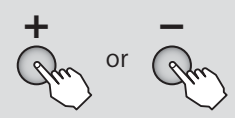



● Select the setting item with the **Jog** key.

```

FLY MOD 1 2 3
*SW POSITION
MODE SW POSI
FM1 OFF SWA CNTR
FM2 OFF SWA DOWN
FM3 OFF SWC CNTR
FM4 OFF SWC DOWN
    
```

Switch selection Switch position

RATE

■ **Type selection**
 Select the "RATE" item and then adjust the rate by pressing the **+ key** or **- key**.

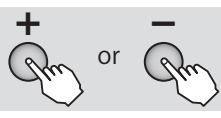

SWITCH

■ **Activating the function**
 ① Select the "MODE" item and then select the "OFF" by pressing the **+ key** or **- key**.
 ● When you do not use a function, set to the "INH" side.

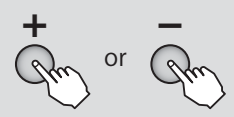

■ **Switch selection**
 ② Change the switch by pressing the **+ key** or **- key** at the switch selection item.
 Range : **SwA-SwD**

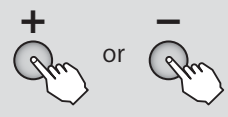

■ **Switch position**
 ③ Select the "POSI" item and then select the position by pressing the **+ key** or **- key**.

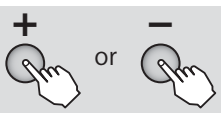

◆ **PRIORITY TYPE** e.g. Setting 5 flight modes in MultiCopter Model Type

[PRIORITY] is select by 3 pages.

```

FLY MOD 1 2 3
CH5 CH6 CH7 CH8
+NOR: --- 100 --- ---
FM1: --- 80 --- ---
FM2: --- 60 --- ---
FM3: --- 40 --- ---
FM4: --- 20 --- ---
        
```

The mode change rate of the multicopter control box (CH6 use)

```

FLY MOD 1 2 3
*SW POSITION
MODE SW POSI
FM1 OFF SWA CNTR
FM2 OFF SWA DOWN
FM3 OFF SWC CNTR
FM4 OFF SWC DOWN
        
```

Flight mode change switch

```

FLY MOD 1 2 3
TYPE PRIORITY (MAX5)
CH5 INH
CH6 ACT
CH7 INH
CH8 INH
        
```

CH6 sets the option to change modes.

SWA	SWC	Flight Mode
		Normal
		F-Mode 1
		F-Mode 2
		F-Mode 3
		F-Mode 4

MultiCopter

◆ **MATRIX TYPE** e.g. Setting up the transmitter to operate the tilt of a camera using switches A and C

[MATRIX] is select by 3 pages.

```

FLY MOD 1 2 3
SW1/2 CH5 CH6 CH7 CH8
+U/U: --- 100 100 ---
U/C: --- 100 50 ---
U/D: --- 100 0 ---
C/U: --- 50 100 ---
C/C: --- 50 50 ---
        
```

Camera tilt control rate

```

FLY MOD 1 2 3
SW1/2 CH5 CH6 CH7 CH8
C/D: --- 50 0 ---
D/U: --- 0 100 ---
D/C: --- 0 50 ---
D/D: --- 0 0 ---
        
```

Camera tilt control rate

```

FLY MOD 1 2 3
TYPE MATRIX (MAX9)
CH5 INH
CH6 ACT
CH7 ACT
CH8 INH
SW1 SWC
        
```

Activating CH6 and CH7 allows the functions to control the camera angle.

SWA	SWC	CAMERA CH6	Servo Rate CH7	
		100	100	
		100	50	
		100	0	
		50	100	
		50	50	
		50	0	
		0	100	
		0	50	
		0	0	



CNT ALM

Center alarm

(MULTICOPT)

Function

- An alarm (single beep) can be sounded at the specified throttle stick position.
- Alarm function ON/OFF can be set by switch.

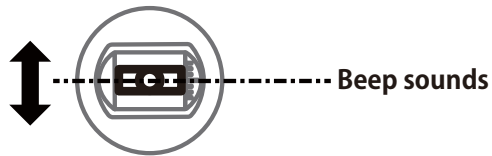

When the THR stick is set to the specified position.

Method

Calling the setting screen

- Call the menu screen from the home screen by pressing the **+** key for 1 second.
- Select **"CNT ALM"** from the menu with the **Jog key**.
- Open the setting screen by pressing the **Jog key**.

- When INH is selected, the function cannot be used. When ON or OFF is selected, the function is activated. ON and OFF changes are linked to the switch.

Labels on the left:

- INH ↔ ON/OFF
- Switch selction → SW ▶ SWA
- Switch direction → POSI ▶ DOWN
- Stick position → STCK ▶ 50% (0%)

Annotations:

- Select the item with the **Jog key**.
- The number in parenthesis is the current throttle stick position.

Annotation:

- This is a throttle stick position alarm. When a throttle stick was besides the slow position and a transmitter was turned on. → Alarm start

Position setting

- Stick position is chosen by **Jog key**.
- Set the throttle stick to the position at which you want to generate the alarm.
- When the **Jog key** is held down the alarm sounds at that position.

Memorize the position at which the beep is to sound.

Multicopter



Function

D/R

The aileron, elevator and rudder channel control rate can be switched in 2(3) steps.

- The control rate is adjusted by each direction of the switch. The direction of each switch can be set individually.

EXP

This function makes operation more pleasant by changing the operating curve so that servo movement is sluggish or sensitive relative to stick operation near the aileron, elevator, throttle, and rudder neutral position. Adjustments can be made in 2(3) steps according to the control rate.

- The "-" side makes servo movement sluggish and the "+" side makes servo movement sensitive near the neutral position. Exponential is applied to entire throttle servo travel. When the "+" side is increased, the slow side becomes sluggish and the high side becomes sensitive.
- Setting corresponding to each rate of dual rate (D/R) is possible. (Except throttle) The direction of each switch and the left and right (up and down) direction of each channel can be set individually.
- When throttle curve function is set, the throttle EXP function cannot be used.

Switch selection (SW)

Switches A to D can be selected as the aileron channel, elevator channel, and rudder channel dual rate (exponential) switch.

- Default : Aileron : SwitchD / Elevator : SwitchA / Rudder : SwitchB

Method

Calling the setting screen

① Call the menu screen from the home screen by pressing the + key for 1 second.



② Select "DR EXP" from the menu with the Jog key.

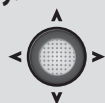

③ Open the setting screen by pressing the Jog key.

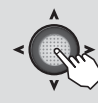

Select the (←) ↔ (→) L,R/U,D with the stick.

Multicopter



D/R

① A channel is chosen by **Jog key**.



Range : **1, 2, 4**

② Adjust the rate by moving the cursor to D/R with the **Jog key**, switching the dual rate switch to the direction you want to set, moving the stick to the left (down) or right (up) side and pressing the **+ key** or **- key**.



Range : **0-140%**
Default : **100%**

- When you want to return the set value to the initial value, press the **+ key** and **- key** simultaneously.

Adjust the rate of each direction of the dual rate switch and stick by repeating step

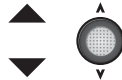

- Moving to another setting item of the same channel is possible by **Jog key**.

EXPO

① Select the "EXP" item and then select the channel with the **Jog key**.



Range : **1-4**

② Adjust the rate by moving the cursor to EXP with the **Jog key**, switching the dual rate switch to the direction you want to set, moving the stick to the left (down) or right (up) side and pressing the **+ key** or **- key**.



Range : **-100 to +100%**
Default : **0%**

- When you want to return the set value to the initial value, press the **+ key** and **- key** simultaneously.

Adjust the rate of each direction of the dual rate switch and stick by repeating step

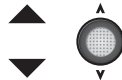

- Moving to another setting item of the same channel is possible by **Jog key**.

Switch Change

① Select the "SW" item and then select the channel with the **Jog key**.



Range : **1, 2, 4**

② A switch is chosen by **+ key** or **-key**.

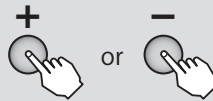

Range : **SwA-SwD**

Multicopter

EXPO TYPE : Throttle only

TYPE ▶ **NORM**

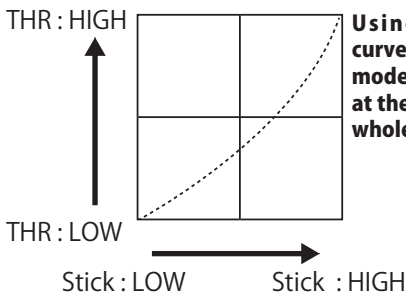

Using the **NORM** curve is helpful in a model is controlled at the throttle stick whole field.

TYPE ▶ **SEPA**

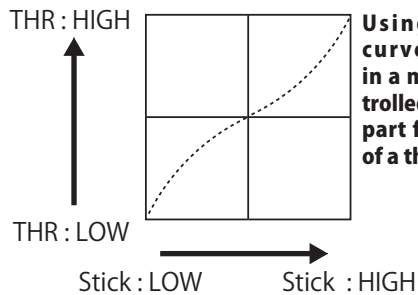

Using the **SEPA** curve is helpful in a model is controlled at an upper part from neutral of a throttle stick.



THR CRV Throttle curve (MULTICOPT)

Function

This function sets a 5 point throttle curve so that the motor speed relative to movement of the throttle stick is the optimum value for flight.

- A curve can be set for each switch position.

When this function is set, the throttle EXP function cannot be used.

Method

Calling the setting screen

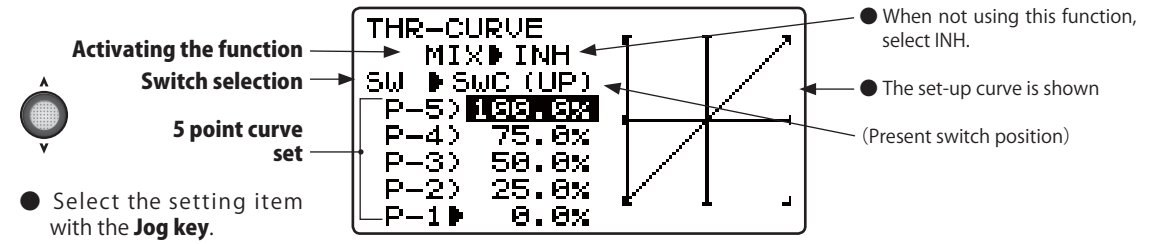
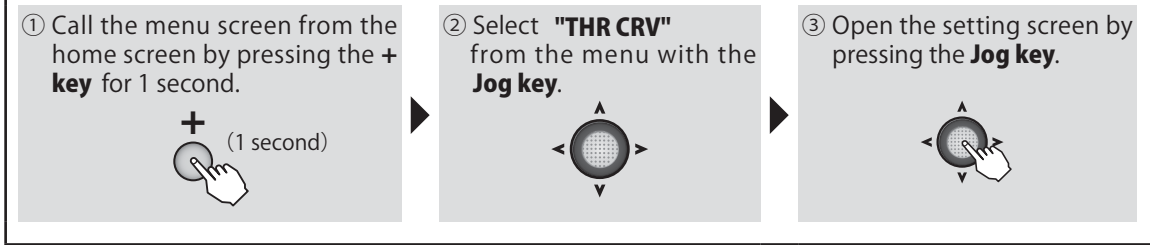

Throttle curve

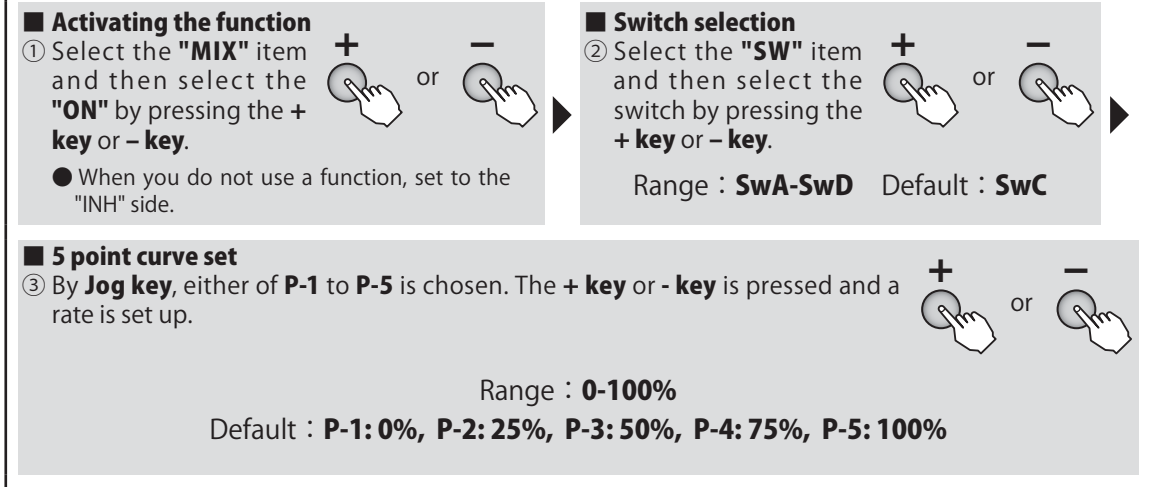

Multicopter



THR DLY Throttle delay (MULTICOPT)

Function

When this function is used, the throttle operating speed can be slowed down.

When the motor response is too sensitive, it's used.

- The amount of delay can be set.

Method

Calling the setting screen

① Call the menu screen from the home screen by pressing the **+** key for 1 second.



② Select "THR DLY" from the menu with the **Jog key**.

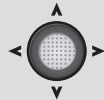

③ Open the setting screen by pressing the **Jog key**.



THR DELAY

MIX ▶ **INH**

Delay Rate set ▶ **RATE 0%**

- When INH is selected, the function cannot be used. To use the function, select ACT.
- (Throttle delay rate)
- It can be set to slow the throttle movement up to +100%

- Select the setting item with the **Jog key**.

Multicopter

THR DELAY

■ Activating the function

① Select the "MIX" item and then select the "ACT" by pressing the **+** key or **-** key.

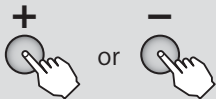

- When you do not use a function, set to the "INH" side.

■ Delay Rate set

② Select the "RATE" item and then adjust the rate by pressing the **+** key or **-** key.

Range : **0-100%**
Default : **0%**

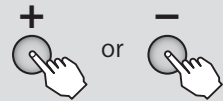

- When you want to return the set value to the initial value, press the **+** key and **-** key simultaneously.



GYRO

Gyro sensor

(MULTICOPT)

Function

This function is dedicated mixing for switching the gyro sensitivity and gyro mode (AVCS/NORMAL) of Futaba airplane use gyros.

- This gyro function isn't used for a flight. A flight gyro is equipped already in a multicopter. (e.g, the angle keep of the camera, it's used.)

Method

Calling the setting screen

- 1 Call the menu screen from the home screen by pressing the **+** key for 1 second.



- 2 Select **"GYRO"** from the menu with the **Jog key**.

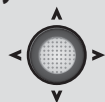

- 3 Open the setting screen by pressing the **Jog key**.

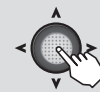

Each switch position
Gyro type / Gain rate

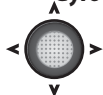

- Select the setting item with the **Jog key**.

GYRO	MIX ▶ INH	SW ▶ SwB
UP ▶ NOR	40%	■
CNT ▶ NOR	20%	
DWN ▶ NOR	10%	

(Gyro type)

(Gyro Gain)

- When not using this function, select INH.

Gain switch selection

(Current switch operating direction)

- Switches to the gain setting screen of each switch direction when the **Jog key** is pressed.



GYRO setup

■ Activating the function

- 1 Select the **"MIX"** item and then select the **"ON"** by pressing the **+** key or **-** key.

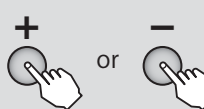

- When you do not use a function, set to the "INH" side.

■ Gain switch selection

- 2 Select the **"SW"** item and then select the switch by pressing the **+** key or **-** key.

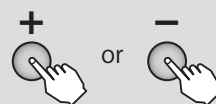

Range : **SwA-SwD** Default : **SwB**

■ Gyro mode and gain setting

- 3 UP, CNT, DWN, shows the switch position. Set the respective positional gain and mode.

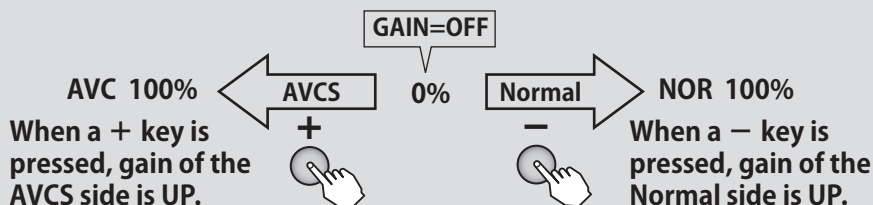

TX SETTING

The settings here are special settings that are unnecessary during normal use. The stick mode can be changed and stick adjustment (calibration), throttle lever reverse, and language can be set.

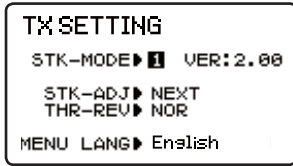

Turn on the power switch with the + key and – key pressed in the power off state. The screen shown at the left appears. To return to the home screen, turn off the power and then turn the power back on without pressing the keys.

■ STK-MODE

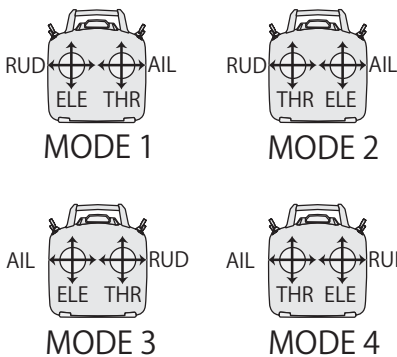

This is the MODE1-MODE4 setting. The initial state is MODE2. To change the mode the stick ratchet must be changed. Request that this be done by Futaba Service. (Charged modification)

■ STK-ADJ

This function is normally not used. If stick deviation should occur, make this adjustment. Do not use it in the normal state.

Calling the setting screen

- Turn off the power and then turn the power back on while pressing the + key and – key simultaneously.

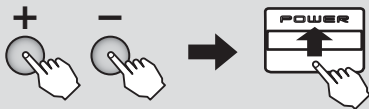

- Select **STK-ADJ** → **NEXT** in the menu with the **Jog key**.

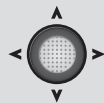

- Enter the setting screen by pressing the **Jog key**.

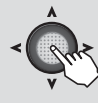

Stick adjustment

- Select the stick you want to adjust with 1-4 with the + key.

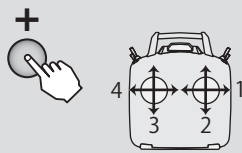

- Press the **Jog key** down and select **NEUT** .

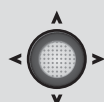

- Set the stick to the **neutral** position and press the **Jog key**.



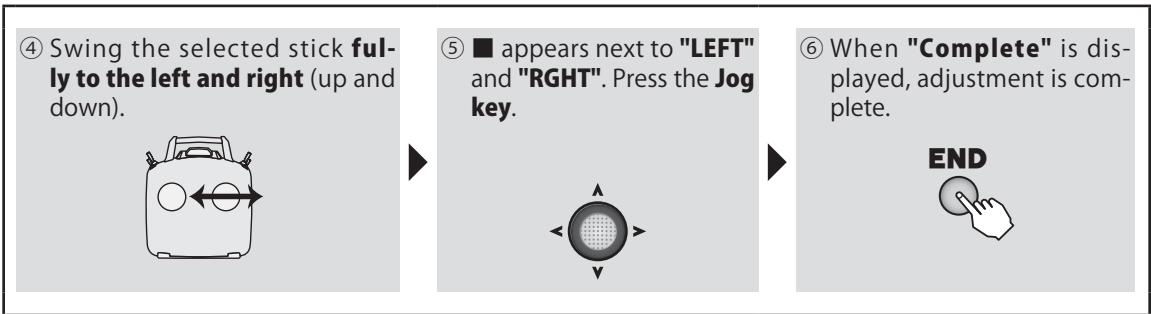

THR-REV

This function is not used. When you want to use full throttle with the throttle stick down and slow with the throttle stick up, select REV. When the stick is up, trim is effective and when the stick is down, trim is not effective.

*Throttle servo operation reversed by the linkage is usually performed by reverse in the normal menu. When throttle servo operation is reversed with the THR-REV function, trim becomes ineffective at slow.

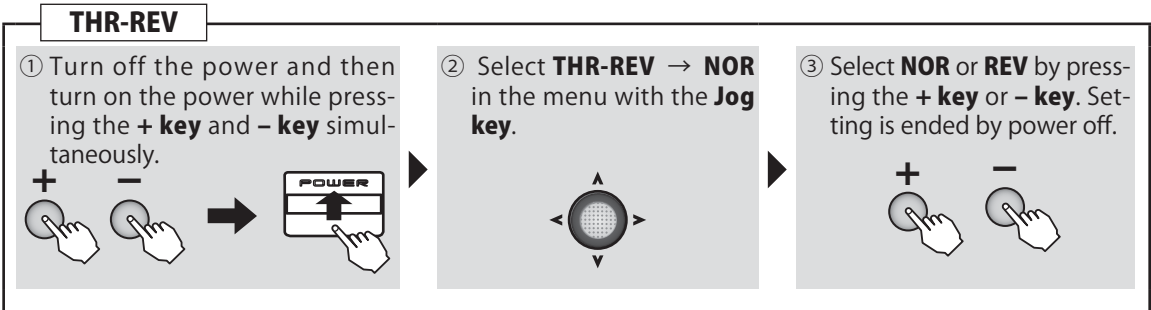

LANGUAGE

The language displayed at proportional can be changed. The initial setting is English, but can be selected from among 7 languages.

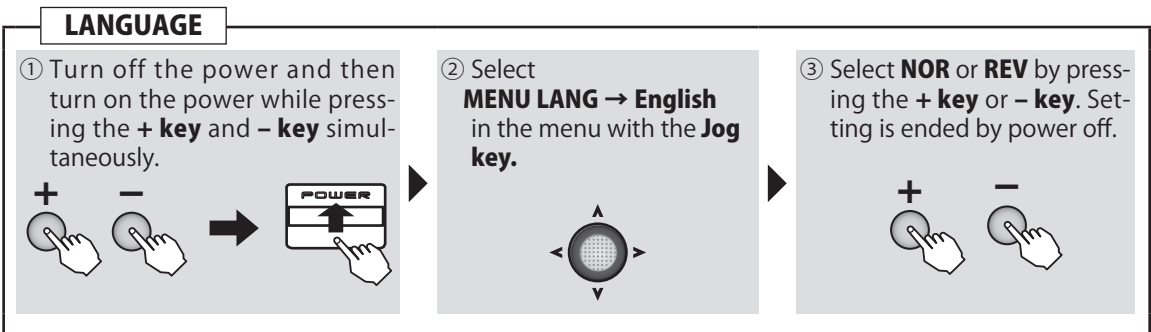

Return from the transmitter setting screen to the normal menu by turning on the power without pressing a key.